

operations manual

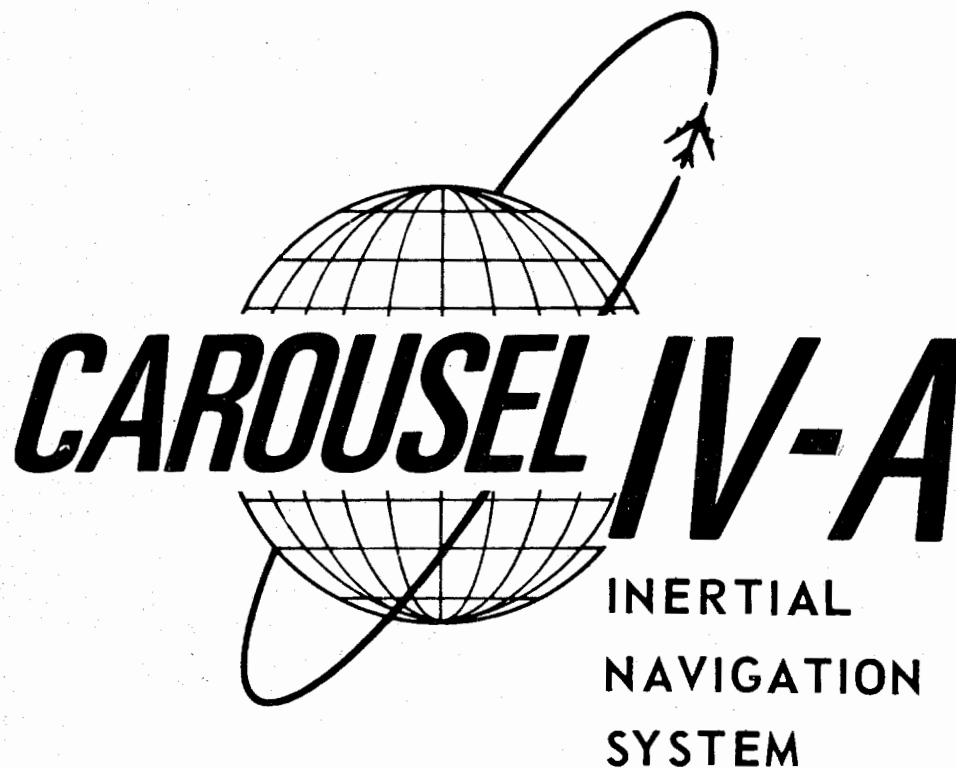

THIS MANUAL IS FURNISHED EXCLUSIVELY
FOR THE OPERATION AND MAINTENANCE OF
THE CAROUSEL IV-A INERTIAL NAVIGATION
SYSTEM. NO OTHER RIGHTS ARE GRANTED.



Delco Electronics

GENERAL MOTORS CORPORATION MILWAUKEE, WISCONSIN 53201

OCTOBER 3, 1973
REVISION 5, FEBRUARY 7, 1977



OPERATIONS MANUAL

LIST OF EFFECTIVE PAGES

Page	Date	Page	Date
Title	Feb 7/77	201	Feb 7/77
		202	Sep 6/76
List of Effective Pages-1/-2	Feb 7/77	203	Feb 7/77
		204	Mar 5/75
		205	Mar 5/75
Record of Revisions	Sep 6/76	206	Feb 7/77
Record of		207	Mar 5/75
Temporary Revisions	Sep 6/76	208	Mar 5/75
Contents-1	Feb 7/77	209	Feb 7/77
Contents-2	Feb 7/77	210	Sep 6/76
		211	Dec 4/74
1	Feb 7/77	212	Dec 4/74
2 thru 4	Sep 6/76	213	Dec 4/74
5 and 6	Feb 7/77	214	Sep 6/76
		215	Sep 6/76
101	Sep 6/76	216	Oct 3/73
102	Mar 4/74	217	Oct 3/73
103	Sep 6/76	218	Oct 3/73
104	Dec 4/74	219	Oct 3/73
105	Feb 7/77	220	Oct 3/73
106	Oct 3/73	221	Feb 7/77
107	Oct 3/73	222	Mar 5/75
108	Oct 3/73	222A/222B	Deleted
109	Dec 4/74	223 thru 232	Feb 7/77
110	Dec 4/74	233/234	Feb 7/77
111	Oct 3/73		
112	Sep 6/76		
113	Dec 4/74		
114	Dec 4/74		
115	Dec 4/74	301	Dec 4/74
116	Oct 3/73	302	Dec 4/74
117	Oct 3/73	303	Dec 4/74
118	Dec 4/74	304	Oct 3/73
119	Dec 4/74	305	Dec 4/74
120	Dec 4/74	306	Dec 4/74
121	Sep 6/76	307/308	Feb 7/77
122	Feb 7/77		
123	Sep 6/76		
124	Dec 4/74		
125	Sep 6/76		
126	Feb 7/77		



OPERATIONS MANUAL

TABLE OF CONTENTS

Subject	Page
INTRODUCTION	1
General	1
Comparison of CIV-A-16 Program to CIV Programs	2
Improvement of CIV-A-18 Program Over CIV-A-16 Program	3
Improvement of CIV-A-19 Program Over CIV-A-18 Program	3
Improvement of CIV-A-20 Program Over CIV-A-19 Program	4
Program Description, CIV-A-II-20	5
Program Description, CIV-A-HHS-20	5
Program Description, CIV-A-21	6
Differences Between CIV-A-22 Program and CIV-A-21 Program	6
DESCRIPTION	101
Purpose	101
Unit Locations	101
Outstanding Features	101
Operating Limitations	103
Navigation Information	103
INS/Airplane Interface	105
Modes of Operation	105
Standby	111
Align	111
Nav	112
Att	112
Malfunctions	113
Unit Descriptions	113
Battery Unit	113
Navigation Unit	113
Mode Selector Unit	115
Control/Display Unit	117
NORMAL OPERATING PROCEDURES	201
Introduction	201
Discussion of Preflight Procedures	227
Alternate Turn-on Procedure	227
Airplane System Indications	227
Discussion of Present Position Insertion	228
Discussion of Manual Insertion of Waypoint Coordinates	228
Discussion of Manual Insertion of DME Station Data	228
Discussion of Data Insertion Using ADEU	228
Discussion of Present Inertial Position	229
Discussion of Present Position Update	229
Discussion of Position Update Eradication	229
Discussion of Manual Flight Plan Change Insertion	229
Remote Operations	230



Delco Electronics

GENERAL MOTORS CORPORATION MILWAUKEE, WISCONSIN 53201

OPERATIONS MANUAL

TABLE OF CONTENTS (CONT)

Subject	Page
Discussion of DME Station Selection	230
Discussion of Aided Inertial Operation	230
Discussion of DME Updating	230
Discussion of Triple INS Mixing	230
Discussion of Desired PI Number	231
Discussion of Indication of Navigation Performance	232
After Landing Procedures	233/234
Remaining in Nav	233/234
Downmoding to Align	233/234
Downmoding to Standby	233/234
Shutdown	233/234
ABNORMAL PROCEDURE	301
Preflight	301
In-flight	301
Action Codes	301
Malfunction Codes	301
Clearing C/DU Lockup	301
C/DU BAT Indicator is Lit	307/308
Abnormal Wind Displays In Flight	307/308



OPERATIONS MANUAL

INTRODUCTION

GENERAL

1. This manual provides operating instructions for the Carousel series Inertial Navigation System (INS) when loaded with a CIV-A operational flight program.

NOTE: Refer to the CIV Operations Manual for operating instructions for the Carousel INS when loaded with a CIV operational flight program and to the CIV-AC Operations Manual when loaded with a CIV-AC operational flight program.

2. System operating instructions utilizing the latest CIV-A operational flight program (CIV-A-21) are included in this revision to the manual. Revisions covering earlier versions of the CIV-A flight program are listed below. The loaded flight program part number is marked on a sticker located on the front panel of the navigation unit (NU) underneath the nameplate. In latter programs, the C/DU left-hand data display will show a partial P/N at turn-on if the C/DU data selector (DSS) is at DSR TK/STS and present position has not been loaded.

<u>Program Tape</u>	<u>Part Number</u>	<u>LH Display</u>		<u>Manual Revision</u>
		<u>DSS at DSR TK/STS</u>		
CIV-A-16	7881711-001	--225		Basic - Oct 3/73
CIV-A-18	7881711-003	--225		Rev. 1 - Mar 4/74
CIV-A-19	7881711-004	--225		Rev. 2 - Dec 4/74
CIV-A-20	7881711-005	11-05		Rev. 4 - Jun 6/76
CIV-A-21	7881711-006	11-06		Rev. 5 - Feb 7/77
CIV-A-22	7881711-007	11-07		Rev. 5 - Feb 7/77
CIV-A-II-20	7881712-002	12-02		Rev. 5 - Feb 7/77
CIV-A-HHS-20	7891320-001	20-01		Rev. 5 - Feb 7/77

NOTE: CIV operational flight programs are identified by their part number 7884663-0XX. CIV-AC flight programs are identified by their part number 7881710-0XX.

3. The operating procedures in this manual can be used for a CIV NU P/N 7883450, when loaded with a CIV-A flight program, with the following significant operational differences:
 - A. The CIV NU cannot receive DME data directly from a DME receiver but can perform DME updating if it receives slant range information from a DME connected CIV-A NU (and PI = 4 is commanded).
 - B. The CIV NU cannot accept flight plan data directly from an Automatic Data Entry Unit (ADEU) but will accept this data from a CIV-A INS connected to an ADEU.



OPERATIONS MANUAL

COMPARISON OF CIV-A-16 PROGRAM TO CIV PROGRAMS

For those who are familiar with the CIV INS, the CIV-A INS; loaded with the CIV-A-16 program, has the following additions, deletions, and changes.

1. Aided inertial operation is available. Aided inertial operation results in the following advantages and differences:
 - A. Data from one or more DME stations can provide a continuous update of present position. When this is being done, the circular error probability (CEP) of the INS is independent of total navigation time and meets the requirements of FAA AC90-45A.
 - B. The FINK output flag (intersystem comparison) now indicates presence and use of a direct DME input for INS position refinement.
 - C. Coordinates, altitude, and frequency of the DME stations are loaded into the INS in much the same way that waypoint coordinates are loaded.
 - D. If no DME station is available, an optimum present position based on the present positions computed by three individual INS can be continuously determined and displayed. All three INS use the optimum present position in their computations, and all three C/DU's display the optimum present position.
2. The HOLD function can not be transmitted from one INS to another. The HOLD key must be pressed on each INS.
3. A standard Automatic Data Entry Unit (ADEU) can be used to load data for up to 7 waypoints and 9 DME stations.
4. Total alignment time to nav ready status is reduced by approximately 2 minutes.
5. Mode 8 has been lengthened from 12 seconds to a minimum of 51 seconds to allow better platform leveling prior to the start of azimuth alignment in mode 7.
6. The alignment process in mode 6 is now identical to that in mode 7. Earth rate compensation is no longer introduced at this stage. Advancement to mode 6 remains conditional upon the loading of present position.
7. Total time in modes 6 and 7 has decreased from a minimum of 10.7 minutes to a minimum of 8.5 minutes.
8. The semi-permanent malfunction code list has been deleted.
9. At ground speeds less than 75 knots, there is a 6 second delay before feedback malfunctions (action code 03) are set. This eliminates false malfunctions which could be set during power transfers prior to takeoff.
10. Malfunction codes 10, 11, 16, 40, 41, 44, 46, 48, 50, and 53 have been eliminated.



Delco Electronics

GENERAL MOTORS CORPORATION MILWAUKEE, WISCONSIN 53201

OPERATIONS MANUAL

11. Malfunction code 55 with a response code 05 has been added. It will be set for an ADEU data transmittal failure.
12. The "77" update (100% update) capability has been eliminated.
13. The true air speed input at which wind is set to zero has been changed to 150 knots.
14. The aircraft must fly each new leg for at least 25.6 seconds before another leg switch can be automatically initiated.
15. The gimbal slew test capability has been eliminated.
16. The "desired PI" number can only be changed after the Nav mode has been entered, and it is used, not to designate a desired PI, but to select normal inertial operation or aided inertial operation and to eradicate previous position fixes.

IMPROVEMENTS OF CIV-A-18 PROGRAM OVER CIV-A-16 PROGRAM

1. Added logic to flash station number in TO side of FROM-TO display when FROM-TO display indicates that DME station data is being displayed.
2. Revised DME reasonableness checks.

IMPROVEMENTS OF THE CIV-A-19 PROGRAM OVER THE CIV-A-18 PROGRAM

1. Malfunction code 55 (data from ADEU fails reasonableness test) will now turn on the C/DU WARN lamp.
2. The action code for malfunction code 18 (excessive time in saturation) has been changed from 01 to 04.
3. Position updates are now flushed by inserting PI = 1 instead of the previous PI = 0.
4. Program was changed to process data from a Digital Air Data Set (DADS) provided the special DIO No. 3A card, P/N 7886346-021, is installed in the NU.
5. Program was changed to accept data from an ADEU card having a new data format.
6. Logic for supersonic operation was deleted from the program.
7. At present position insertion, a comparison is made between the inserted position and the last computed position. Malfunction code 41 with action code 04 is set if the difference is greater than 76 nmi.



Delco Electronics

GENERAL MOTORS CORPORATION MILWAUKEE, WISCONSIN 53201

OPERATIONS MANUAL

IMPROVEMENTS OF THE CIV-A-20 PROGRAM OVER THE CIV-A-19 PROGRAM

1. The wind display logic was changed to zero the wind displays whenever the true air speed (TAS) input from the air data set (ADS) is at the lower stop setting in the ADS.
2. The countdown during align of the PI number from 5 to 0 was changed and is now time dependent with a fixed 3.4 minute interval between steps so that PI = 0 is reached 17 minutes after PI = 5 has been initiated. PI countdown to 5 has always been time dependent and remains unchanged.
3. The NU mounting logic was changed to allow mounting the NU athwartship (NU handles pointing to the right or left wing). Note that the pitch and roll attitude outputs are not to TSO C4c definitions and that special aircraft wiring is required when the NU is mounted athwartship.
4. The "triple mix" position determination logic has been revised to include a filter to eliminate a two state position error that was theoretically possible in the CIV-A-19 program under certain combinations of track, intersystem timing, and position dispersal. (The two states would have parallel paths separated by no more than a few hundred feet and would have no perceivable effect on aircraft operation, except for a "jitter" in the HSI XTK display that might be noticeable and objectionable.)
5. The "triple mix" routine was also changed to correct a logic error in previous programs that would select the third direction cosine if the other two direction cosines were exactly equal.
6. A recallable semi-permanent malfunction code list has been added that is similar to that used in the CIV series flight programs. Recall is accomplished by simultaneously depressing TEST and HOLD on the C/DU. The semi-permanent list is cleared upon entry to align (PI = 7).
7. The filtering of the TAS input was eliminated to improve the response of the wind displays to sudden wind changes.
8. The altitude logic was revised to provide continuous comparison between the barometric altitude input and the velocity/altitude flight profile. The program will select the most reasonable input.
9. The coefficients of the canned altitude loop were slightly changed to better match an actual velocity/altitude flight profile. The canned altitude limit was increased to 35,000 feet.



Delco Electronics

GENERAL MOTORS CORPORATION MILWAUKEE, WISCONSIN 53201

OPERATIONS MANUAL

10. The delay logic used to inhibit the issuance of feedback malfunction (MC 22, 23, 24, and 25) at ground speeds less than 75 knots was revised to correct an error that could, under certain unusual conditions, temporarily inhibit the issuance of these malf codes.
11. The ADEU processing logic was changed to periodically initialize the ADEU input cells in order to clear erroneous data which may have been loaded by the trailing edge of an improperly trimmed ADEU data card.
12. A program identifier display was added that causes the left data display on the C/DU to read "11 05" when the data selector is at DSRTK/STS and present position has not been loaded.
13. The feet per nautical mile constant used for calculating displayed Distance-to-Go was changed to give 5400 nmi as the distance from equator to pole. This coefficient is not used in any of the navigation equations.
14. The delay previously incorporated in the downmode to standby was deleted.
15. The "Position Update Eradication" procedure (the flush procedure), which is commanded by inserting a desired PI = 1 during NAV, was changed to have the desired PI number automatically reset to "5" immediately after the flush is accomplished. With previous programs, the system would remain in the flush mode (PI = 1) until the operator inserted a new PI number. This change was made to avoid system acceptance of an undesired fix which otherwise could occur under an unusual set of circumstances.

PROGRAM DESCRIPTION, CIV-A-II-20

1. The CIV-A-II-20 flight program is the CIV-A-20 flight program (see above) with only a slight modification to the logic used when checking the external program control pins. The logic is identical to the CIV-A-20 program, except that when the NU is installed in an aircraft where the control pins are wired for an analog (voltage ratio) source, the program will first check the DADS input channel. If there is data present in this channel, the program will perform calculations using DADS based equations, but if there is no data, the program will perform calculations using analog based equations. (See Service Bulletin 34-40-01-43 for more details.)

PROGRAM DESCRIPTION, CIV-A-HHS-20

1. The CIV-A-HHS-20 flight program is the CIV-A-20 flight program (see above) with Digital Air Data Set (DADS) processing logic removed to gain program space required to add logic for a heading/hold select mode. This special mode steers the aircraft on a heading referenced to true north rather than on a great circle path between two waypoints. The pilot can either fly the heading of the aircraft at the time the mode was selected or can insert any desired heading.



Delco Electronics

GENERAL MOTORS CORPORATION MILWAUKEE, WISCONSIN 53201

OPERATIONS MANUAL

PROGRAM DESCRIPTION, CIV-A-21

1. The interpretation logic used when checking external control pin logic for the desired HSI and steering interface was changed to output DSRTK if both pins J1A-1 (TK) and J1A-2 (TKE+DA) are connected to J1A-3 (common).
2. The displayed PI number during NAV has been made representative of predicted navigation performance. The displayed PI number then becomes the AI number (accuracy index number) during the Nav mode.
3. Only the C/DU WARN indicator is lit when ADEU data fails reasonableness tests.
4. The gimbal angle rate check (MC 57) made during align was tightened for earlier detection of "taxi-in align".
5. The limiting value for ΔV calculations during align was increased to ensure proper alignment even when encountering aircraft motions during passenger and cargo loading.
6. The DME delta range check was modified to more closely reflect actual operating conditions.

DIFFERENCES BETWEEN CIV-A-22 PROGRAM AND CIV-A-21 PROGRAM

1. The ground speed at which the determination of the Air Data Set "stop" value is made is changed from 37.5 to 75 knots.
2. The preflight TAS assumed "stop" value has been reduced from 192 knots to 170 knots to allow a self-test to be accomplished with certain Air Data computers.
3. The TAS logic for analog inputs has been changed to provide proper processing for TAS less than 100 knots.



OPERATIONS MANUAL

SECTION 1

DESCRIPTION

PURPOSE

The Delco Electronics Carousel IV-A Inertial Navigation System (INS) continuously computes horizontal navigation data and senses airplane attitude displacement in pitch, roll, and yaw from a local vertical and horizontal reference. Output signals from the INS are used to automatically steer the airplane over a preselected course, to maintain the airplane and weather radar display at a level attitude, to stabilize magnetic compass signals, and to display navigation data and airplane attitude on navigation and flight instruments. Each INS furnishes its own numerical display of navigation data and indicates its own operating status.

UNIT LOCATIONS

1. Each INS consists of four units: the mode selector unit (MSU), the control/display unit (C/DU), the navigation unit (NU), and the battery unit (BU). See figure 101. Either two or three separate systems are installed in the airplane. The unit locations are as follows:
 - A. Mode selector units - Pilot's overhead panel
 - B. Control/display units - Control stand electronic panel
 - C. Navigation units - Main equipment center
 - D. Battery units - Main equipment center
2. An Automatic Data Entry Unit (ADEU), such as Raymond Engineering Inc., Model 7901, is not part of the INS, but is useful in loading waypoint and DME data.

OUTSTANDING FEATURES

The INS is characterized by the following features:

- A. Automatic alignment of the INS to true north and automatic calibration of the horizontal instruments are accomplished each time the INS sequences from STANDBY through completion of fine align and NAV is entered.
- B. Automatic calibration of the azimuth (vertical) gyro is accomplished as follows:
 1. An automatic calibration based on the results of the preceding flight is accomplished during the subsequent alignment.
 2. A further refinement of the calibration, based on alignment data, is accomplished automatically at entry into NAV if an alignment to mode 4 or lower is obtained. IT SHOULD BE NOTED THAT THIS FURTHER REFINEMENT SHOULD IN NO WAY BE CONSTRUED AS A REQUIREMENT TO ACHIEVE THE SPECIFIED INS ACCURACY.
- C. The INS can be operated as a self-contained inertial system or can be automatically updated by radio navigation (DME) signals when such signals are available.



Delco Electronics

GENERAL MOTORS CORPORATION MILWAUKEE, WISCONSIN 53201

OPERATIONS MANUAL

CONTROL/DISPLAY UNIT

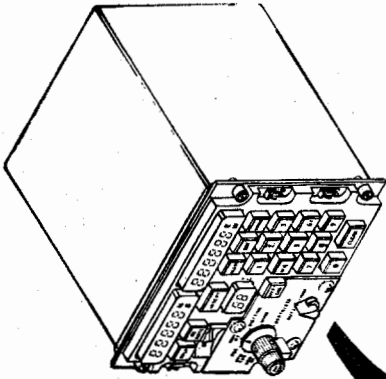

BATTERY UNIT

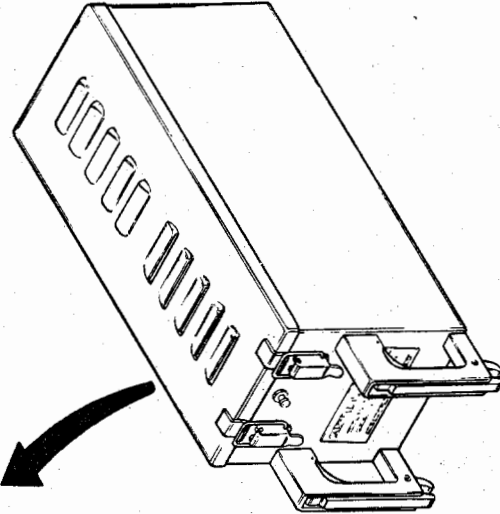

MODE SELECTOR UNIT

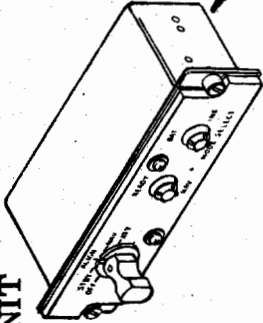

NAVIGATION UNIT

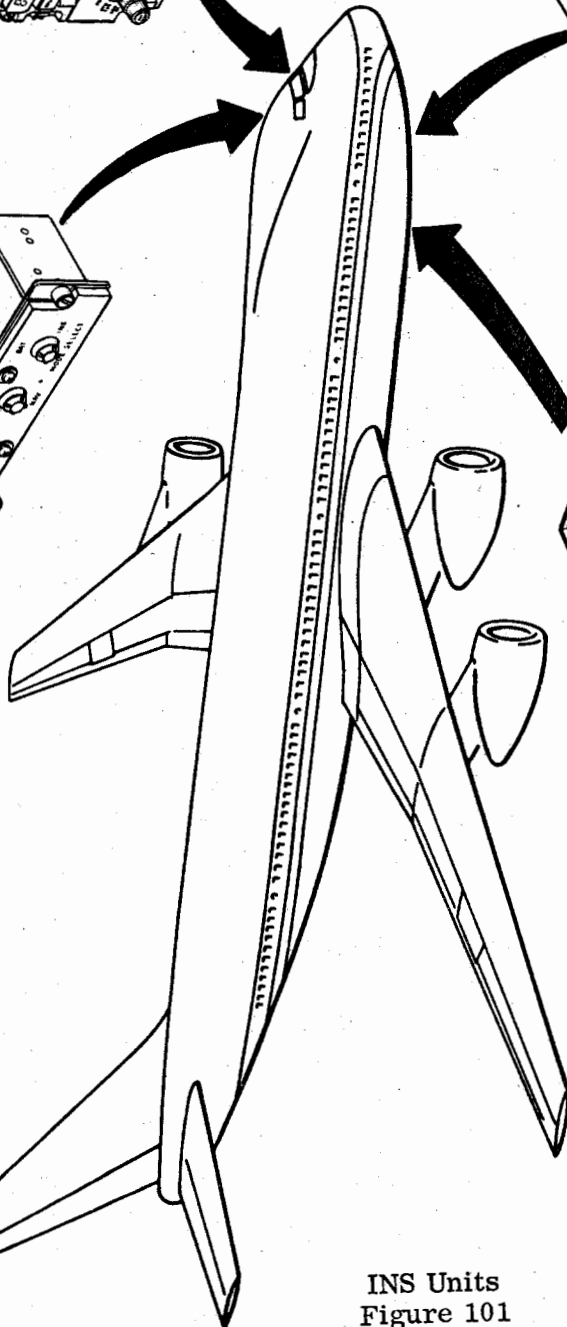
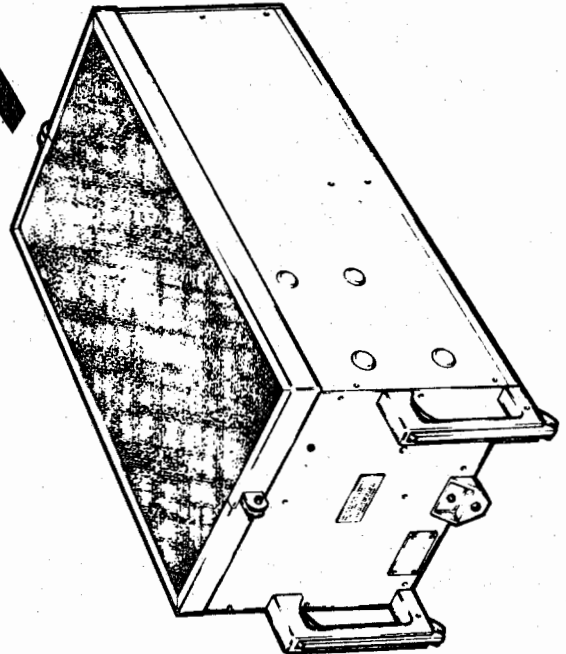

INS Units
Figure 101



OPERATIONS MANUAL

- D. If no radio navigation signals are available, manual position updates can be made whenever an accurate present position reference is available.
- E. If neither radio navigation signals nor a present position reference is available, the INS can improve its accuracy by mixing three inertial positions and generating an optimum displayed present position.
- F. Each INS continuously monitors its own performance and furnishes warning indications if output signals and displayed data become unreliable. In addition, code numbers are displayed to recommend action and to identify the cause of the warning.
- G. Waypoint coordinates and DME station coordinates, altitude, and frequency can be inserted manually through a keyboard or automatically through an optional Automatic Data Entry Unit (ADEU). This information can be inserted into all INS simultaneously or into each INS separately.
- H. Accurate INS operation is unlimited for any latitude and longitude during flight.
- I. Navigation information and steering commands are computed for flight over the great circle route between each set of waypoint coordinates inserted in the INS insuring the shortest route between the waypoints.
- J. Although barometric altitude and true airspeed from an air data set are inputs to the INS, loss of these inputs will not seriously affect INS navigation operation. Altitude information is required to achieve the desired accuracies for approach applications in RNAV operation.
- K. An INS can be used to produce only attitude stabilization signals if navigation and/or steering signals become unreliable.
- L. Indicating lights and displays can be replaced while the INS is operating without hazard to equipment or personnel.

OPERATING LIMITATIONS

Automatic alignment and calibration of the INS can be performed only while the airplane is parked. Alignment degradation occurs if the alignment is performed at a latitude greater than 80 degrees.

NAVIGATION INFORMATION

Navigation information determined by the INS is defined in the following paragraphs and illustrated in figure 102.

True heading (HDG) is the clockwise angle from true north to the airplane center line.

Wind speed (WS) is the velocity of the wind with respect to a point on the earth's surface.

Wind direction (WD) is the clockwise angle from true north to the wind velocity vector.

Ground track angle (TK) is the clockwise angle from true north to an imaginary line on the earth's surface connecting successive points over which the airplane has flown (ground track).

Ground speed (GS) is the velocity of the airplane with respect to a point on the earth's surface.



OPERATIONS MANUAL

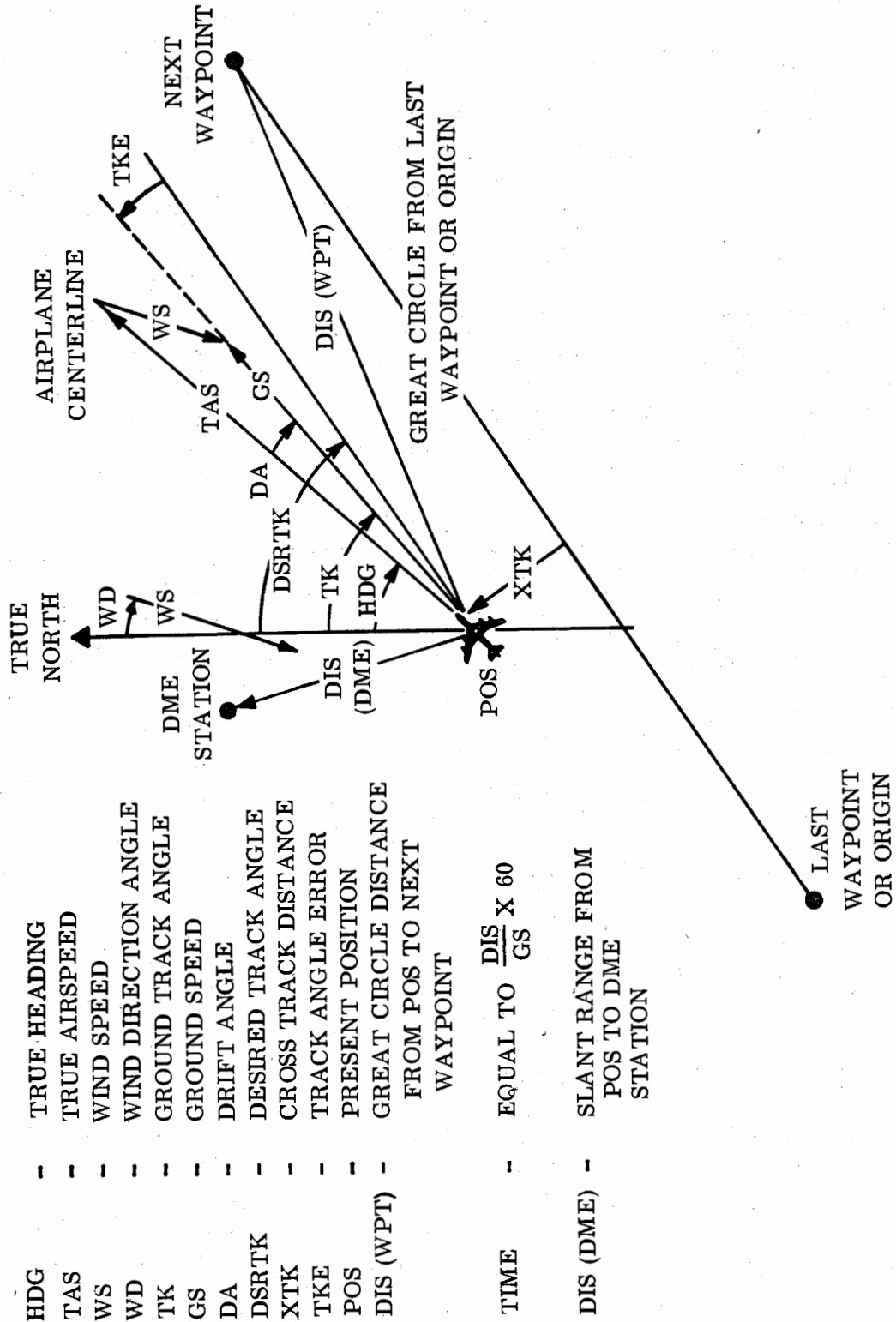

- HDG - TRUE HEADING
- TAS - TRUE AIRSPEED
- WS - WIND SPEED
- WD - WIND DIRECTION ANGLE
- TK - GROUND TRACK ANGLE
- GS - GROUND SPEED
- DA - DRIFT ANGLE
- DSRTK - DESIRED TRACK ANGLE
- XTK - CROSS TRACK DISTANCE
- TKE - TRACK ANGLE ERROR
- POS - PRESENT POSITION
- DIS (WPT) - GREAT CIRCLE DISTANCE FROM POS TO NEXT WAYPOINT
- TIME - EQUAL TO $\frac{DIS}{GS} \times 60$
- DIS (DME) - SLANT RANGE FROM POS TO DME STATION

Navigation Information Relationships

Figure 102



Delco Electronics

GENERAL MOTORS CORPORATION, MILWAUKEE, WISCONSIN 53001

OPERATIONS MANUAL

Drift angle (DA) is the angle between the airplane center line and ground track or the angular difference between true heading and ground track angle. Drift angle is right when ground track angle is greater than true heading and left when ground track angle is less than true heading.

Desired track angle (DSRTK) is the clockwise angle from true north to an imaginary line on the earth's surface connecting successive points over which flight is desired (desired track). This line describes the great circle course between two successive waypoints and it is further defined by the intersection of a plane and the earth's surface when the plane passes through the two successive waypoints and the center of the earth.

Present position (POS) is the actual latitude and longitude coordinates of the point on the earth's surface directly below the airplane at any given instant.

Cross track distance (XTK) is the shortest distance between the airplane's present position and the desired track. Cross track distance is left when present position is left of the desired track and right when present position is right of the desired track. Cross track deviation (XTK DEV) is another term used for cross track distance.

Track angle error (TKE) is the angle between the airplane's actual ground track and the desired ground track or the angular difference between ground track angle and desired track angle. Track angle error is left when the actual track angle is less than the desired track angle and right when the actual track angle is greater than the desired track angle.

Distance (DIS) is the great circle distance between present position and a waypoint or the calculated great circle distance (not slant range) from present position to the DME station designated by the waypoint/DME selector (thumbwheel switch).

Time (TIME) is the time in minutes to fly the great circle course from present position to the next waypoint at the present ground speed.

True airspeed (TAS), although not determined by the INS, is the velocity of the airplane with respect to the air mass around the airplane. The INS uses true airspeed to determine wind direction and wind speed.

INS/AIRPLANE INTERFACE

Figures 103, 104, 105, 106, and 107 illustrate the general interface between the units of three INS and other airplane systems. All INS output signals are shown although they will not necessarily all be used on any one airplane configuration. Airplane equipment is also shown which will not necessarily be installed in all airplane configurations.

MODES OF OPERATION

The INS can operate in four major modes: Standby, Align, Navigate (Nav), and Attitude (Att). When the INS is turned on, it will, under normal conditions, proceed through the Standby and Align modes and enter Nav, where it will remain until it is downmoded at the end of a flight. The only exceptions would be in the event of a malfunction, in which case the INS would be either shut down or placed in the Att mode. In the Att mode, the computer is turned off and the INS provides only attitude signals.

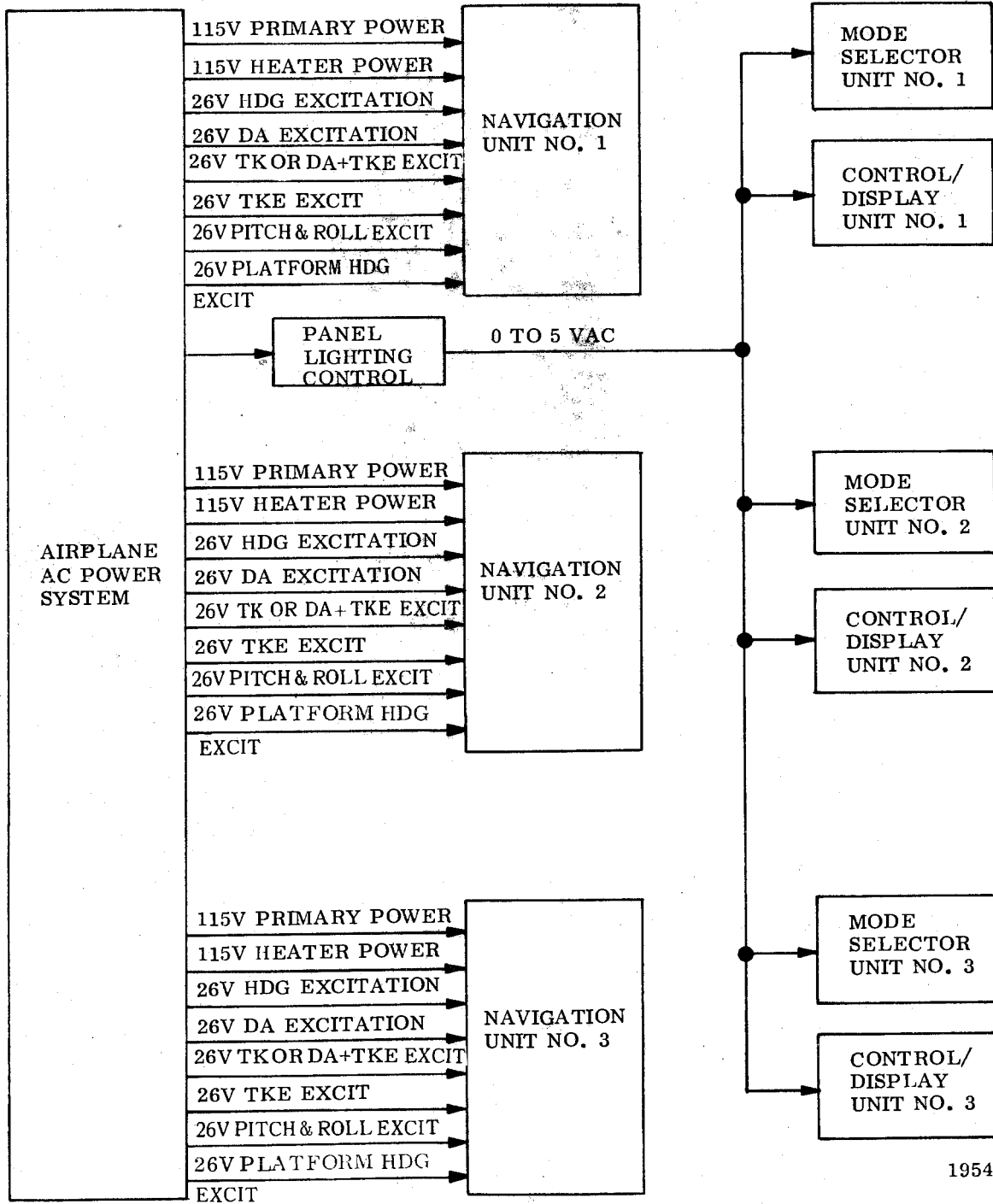
OPERATIONS MANUAL

19546A



OPERATIONS MANUAL

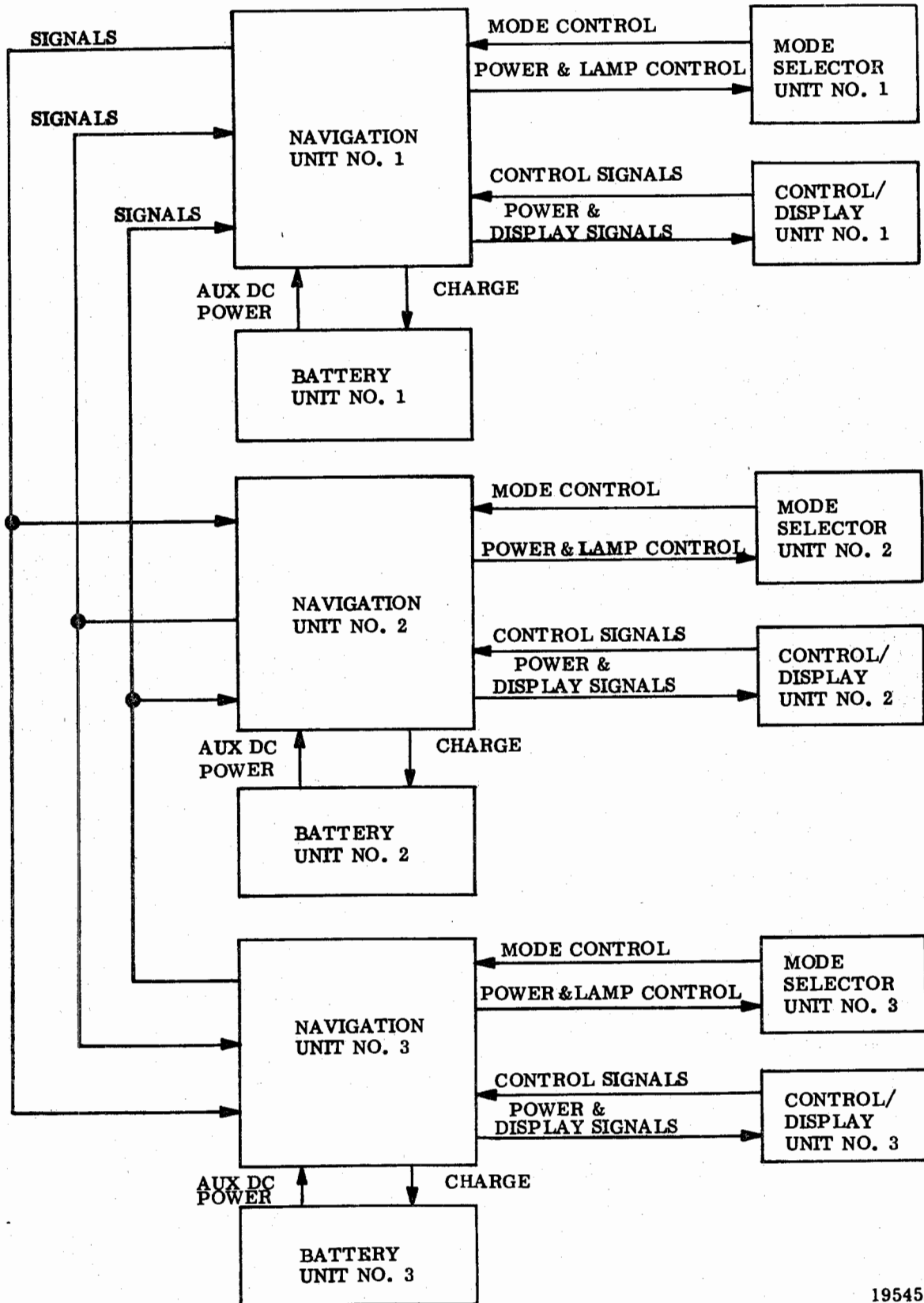

INS Inter-Unit Signals
Figure 104

19545A



OPERATIONS MANUAL

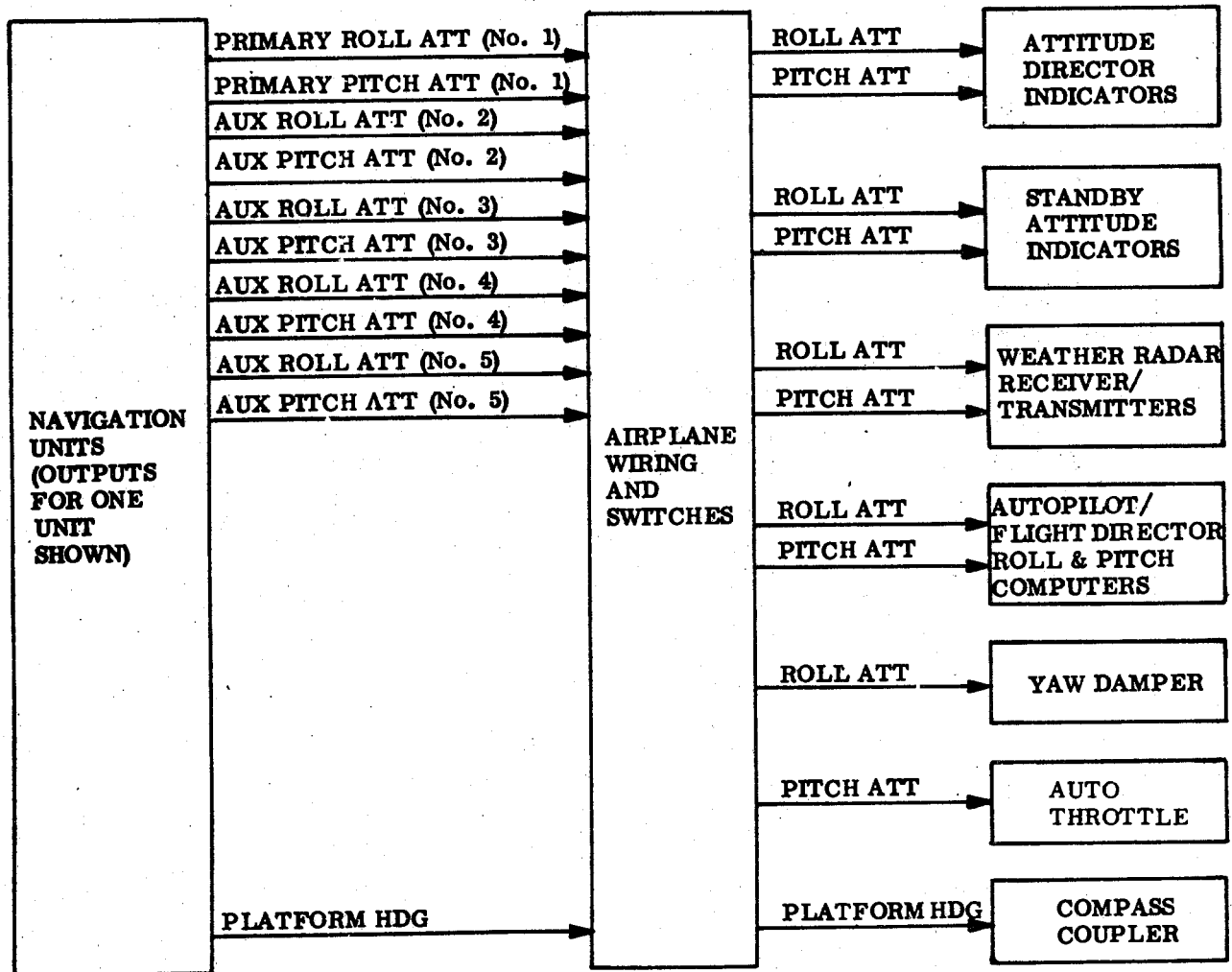

INS Attitude Output Signals
Figure 105



OPERATIONS MANUAL

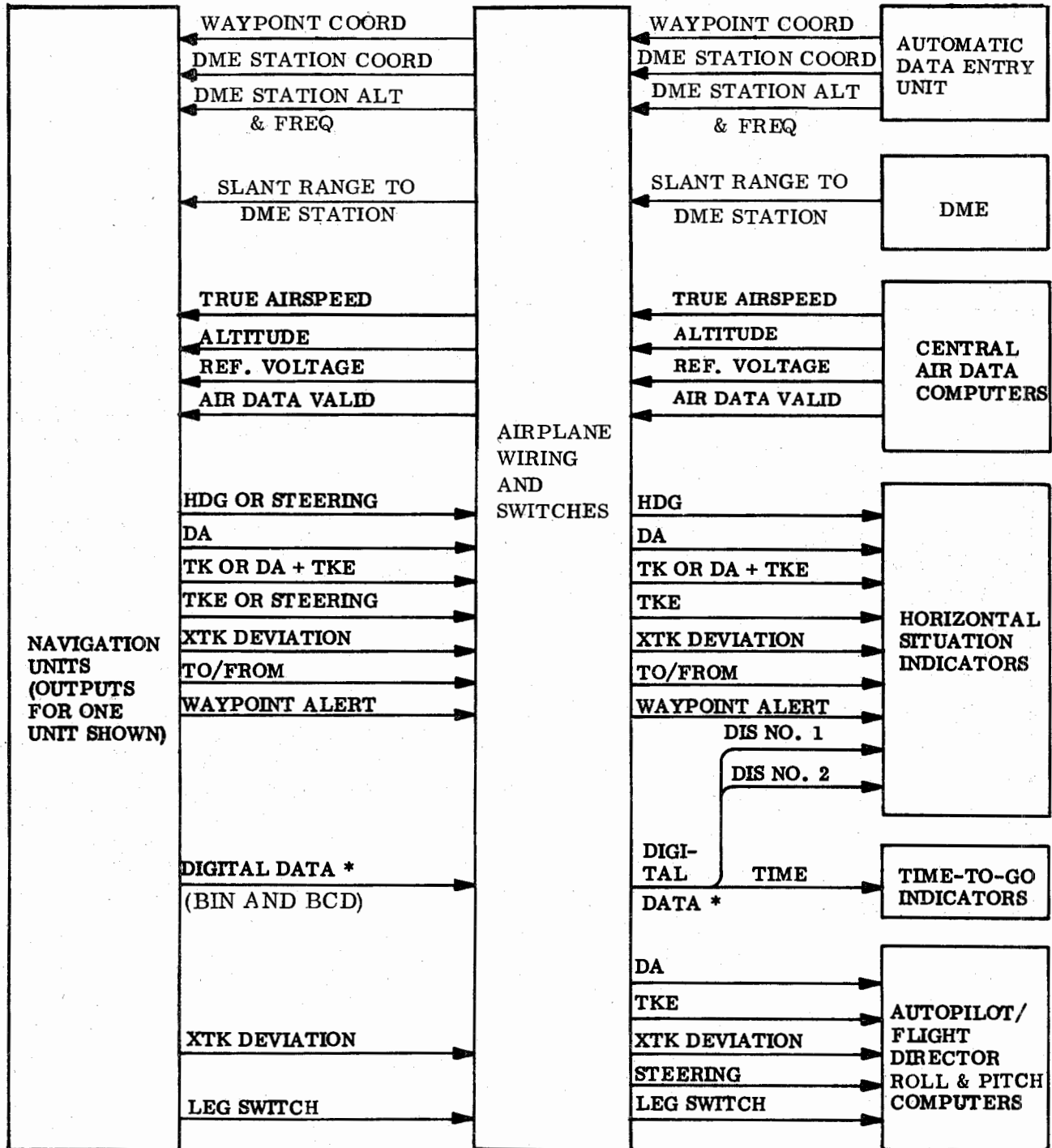

* DIGITAL DATA SIGNALS INCLUDE POS, TK, GS, WS, WD, XTK, TKE, HDG, DA, DSRTK, WYPT POSITIONS, ATA, AND ALIGNMENT STATUS AVAILABLE FOR DIGITAL DISPLAY.

19543



OPERATIONS MANUAL

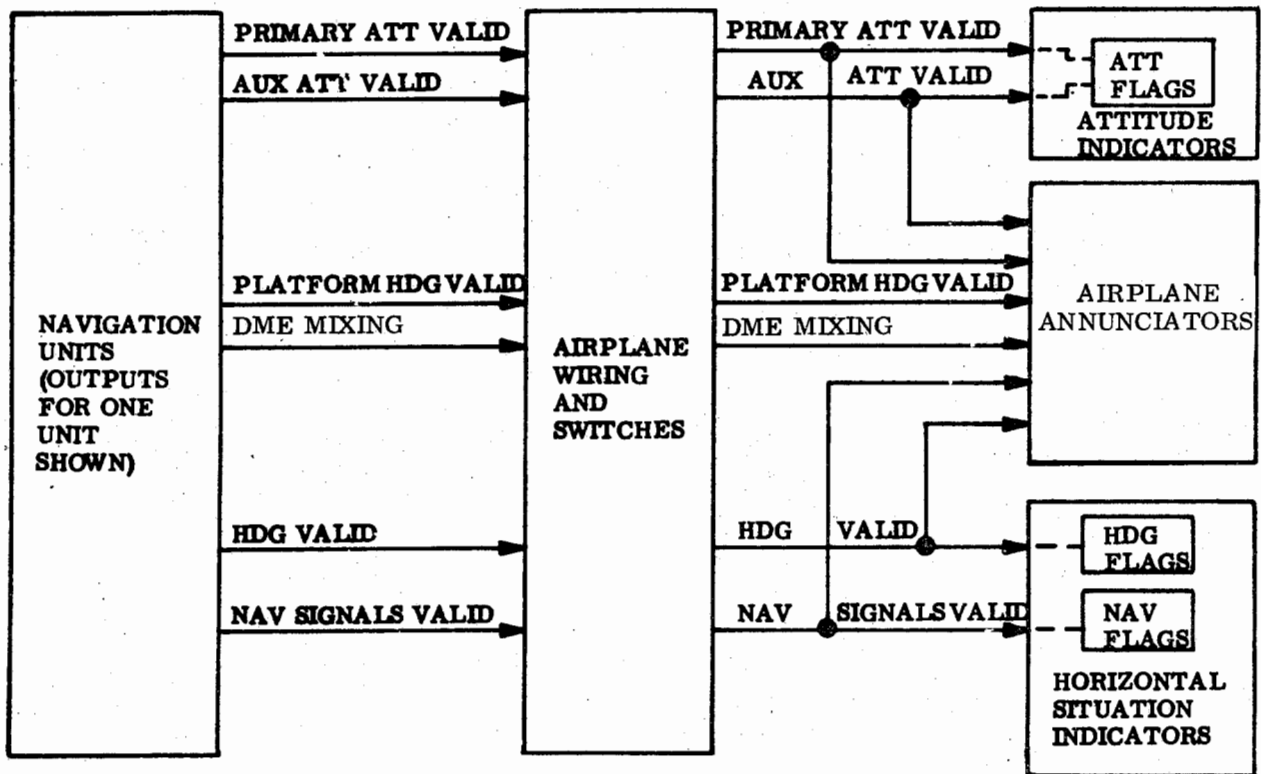

19542A

INS Output Warning and Status Signals
Figure 107



Delco Electronics

GENERAL MOTORS CORPORATION MILWAUKEE WISCONSIN 53201

OPERATIONS MANUAL

The status of the INS can also be identified by a series of computer mode numbers which appear in the 5th digit of the right-hand data display when the data selector is set to DSRTK/STS. During Standby, the mode number is 9. As the INS enters Align, the mode number goes to 8 and decreases toward 0 as successive stages of the alignment process are completed. The mode number will continue to decrease until either the Nav mode is entered or the mode number reaches 0. The Nav mode can be entered any time after the mode number has reached 5. During Att mode, the computer and C/DU are shut down and no mode number is provided.

STANDBY

The characteristics of the Standby mode vary, depending on whether the INS is being turned on or is being downmoded from Nav, Align, or Att.

If the INS is being turned on, the Nav Unit is brought up to operating temperature by fast warmup heaters and the gyro wheels are brought up to speed. Also, the INS platform is aligned to the aircraft axes, and all instrument warning lamps controlled by the INS indicate warning.

If the INS is being downmoded from a higher mode, the INS platform retains its alignment with local horizontal, and all instrument flags controlled by the INS except the Attitude and Platform Heading flags will indicate warning.

In both cases, present position and waypoint coordinates and DME station data can be inserted into the INS.

ALIGN

As indicated above, the INS computer progresses through a series of submodes in Align.

MODE 8

During mode 8, the INS platform is aligned to local horizontal, and the INS battery is tested. Attitude warnings are removed at the beginning of mode 8, but all other instrument flags controlled by the INS continue to indicate warning. The INS spends a minimum of 51 seconds in mode 8.

MODES 7 AND 6

The primary function of modes 7 and 6 is to establish a known relationship between the INS platform and true north. This function continues unchanged throughout both modes. Loading present position into the INS allows it to go from mode 7 to mode 6. In mode 6, the INS compares the latitude of the loaded present position with the latitude it has computed as part of the alignment process, and it uses the results of this comparison, together with other information, to update certain self-calibration data.



OPERATIONS MANUAL

Assuming present position is loaded and the INS is allowed to progress to mode 6 shortly after it enters mode 7, the total time spent in the two modes will not exceed approximately 8.5 minutes.

MODE 5

Entry into mode 5 indicates that an adequate alignment of the INS platform has been achieved. The Nav mode can now be entered by setting the mode selector to NAV. The READY NAV lamp on the MSU will light when mode 5 is entered.

MODES 4 THRU 0

Modes 4 through 0 indicate continuing operation of the self-calibration process begun in modes 6 and 5. If the INS is left in Align, the self-calibration data will continue to be refined and the mode number will decrease to 0 as a straight line time dependent function so $PI = 0$ is reached 17 minutes after $PI = 5$ has been initiated. Each step in the countdown ($PI = 5, = 4, = 3, = 2, = 1$) takes the same amount of time (approximately 3.4 minutes).

NAV

In the Nav mode, all navigation data is computed and available for display. All warning flags controlled by the INS disappear from view. Two types of operation are available in the Nav mode: Normal inertial operation and aided inertial operation.

NORMAL INERTIAL OPERATION

Each INS operates independently and depends on its own inertial instruments for all position and velocity data. The present position computed by each INS can be updated manually when the aircraft passes over a known position reference.

AIDED INERTIAL OPERATION

If one or more DME stations are within range, any or all of the INS can be automatically updated. If no DME stations are available and if there are three INS on board, all operating in the NAV mode, each INS commanded to do aided inertial/triple INS mixing ($PI = 4$) will update its present position approximately to the mid latitude and mid longitude of the three systems.

ATT

In the Att mode, the computer and C/DU are shut down, and no displays are available. It is entered at the pilot's discretion if navigation and/or steering data signals become unreliable. Attitude signals and platform heading outputs continue to be available. The Nav mode can not be re-entered from the Att mode unless the system is realigned. Alignment can take place only on the ground.



OPERATIONS MANUAL

MALFUNCTIONS

Most malfunctions of the INS will cause a warning lamp on the C/DU to light and will provide a series of numerical codes which define the action to be taken and the nature of the malfunction. (These codes are listed in section 3 of this manual.) If prime power is lost, the INS will switch to its own battery and if the battery is low, the INS will shut itself down and light a lamp to indicate the battery failure. If the NU becomes overheated, the INS will either shut itself down (in Standby or Align mode) or light the warning lamp (Nav mode).

UNIT DESCRIPTIONS

BATTERY UNIT

The battery unit provides auxiliary dc power to initiate INS turn on and to supply essential power to maintain INS operation should the 115 volt primary power be interrupted after INS turn on. The battery unit will sustain operation of the INS for a period of 15 minutes. A larger capacity battery unit is available which will sustain INS operation for a period of 30 minutes. Each INS has its own battery unit. Refer to figure 104.

NAVIGATION UNIT (NU)

The NU contains an inertial reference unit (IRU), a digital computer unit (DCU), and inertial reference unit electronics (IRUE). All INS attitude, navigation, and steering information is determined in the NU.

The IRU is a gyro stabilized platform and gimbal assembly which is electronically controlled to provide a local horizontal azimuth reference regardless of airplane attitude. Synchros in the IRU produce signals proportional to the attitude displacement of the airplane from the horizontal reference and changes in airplane heading from the azimuth reference. The synchros are positioned so that the signals represent attitude displacements about the airplane longitudinal (roll), lateral (pitch), and vertical (azimuth) axes. Accelerometers mounted on the gyro stabilized platform are used to produce signals proportional to vertical and horizontal accelerations (velocity changes) during the navigation mode of operation and proportional to platform tilt during the alignment and attitude modes of operation. The accelerometers which sense horizontal accelerations are mounted on a platform which is rotated at approximately one rpm about the vertical. This rotation results in improved navigation performance and allows automatic alignment and calibration of the INS.

During alignment, the gyros on the platform sense the earth's rotation and the accelerometers sense a component of gravity when the platform is not level. The computer uses the resulting outputs of the accelerometers to determine the platform's relationship to true north and to level the platform with respect to local vertical. Other operations, such as the comparison of the actual present position with the last computed present position from the previous flight, provide calibration data.



Delco Electronics

GENERAL MOTORS CORPORATION MILWAUKEE WISCONSIN 53201

OPERATIONS MANUAL

During navigation, the computer uses the accelerometer output signals to compute navigation and steering information and to develop gyro torquing signals which maintain the IRU oriented to local horizontal. In the navigation mode, acceleration signals are caused by movement of the airplane.

The computer can perform continuous automatic position updates whenever the slant range to one or more DME stations are available. The continuously updated aircraft position is used in generating all navigation and steering information.

The computer continuously compares DME input information and computed information for reasonableness. It also receives warning signals from hardware monitors in the IRU and IRUE. If a failure or out-of-tolerance condition is detected by the computer, it provides output signals which will indicate one or more warnings. The computer will also provide codes to the C/DU upon request indicating the recommended action and the failure being detected.

The IRUE includes power circuits, temperature control circuits, and circuits required for interface between the IRU, computer, MSU, C/DU, and battery unit, and for malfunction warning control signals.

The power circuits change the 115 Vac primary power (or 24 vdc power from the battery unit when 115 V 400 Hz power is not available) to the various ac and dc voltages required for system operation. The INS cannot be turned on unless both battery unit and primary power are available, but can operate on either power after turnon. A battery charger is included in the IRUE which automatically charges the battery unit at a constant current during INS operation if the battery potential is low and the INS is not operating on battery unit power. At other times, when the INS is on, a trickle charge is maintained on the battery unit by the battery charger.

The temperature control circuits provide stable temperature for critical assemblies in the NU. Fast warmup circuits and internal blowers for the IRU use the 115 volt heater power. Fine temperature control circuits use converted primary power. Both fast warmup heaters and fine temperature control heaters warm up the NU at turn on. The fast warmup heaters shut off just before operating temperatures are reached and the fine temperature control heaters continue operating to maintain the required operating temperature. The INS cannot be aligned until the fast warmup heaters shut off.

The walls of the NU incorporate primary heat exchangers through which exhaust cabin air flows. Heat from the electronics in the IRU, IRUE, and computer is dissipated through mechanical connections to the heat exchanger and by bleed air flowing past the card surfaces. The cooling is required for both the heated and unheated assemblies. Heat dissipation from the heated assemblies allows positive temperature control. The IRU compartment of the NU includes secondary heat exchangers attached to the inside of the primary heat exchangers. Two blowers operate when the gimbal compartment temperature reaches a predetermined level (about 115°F (46°C)). The blowers are positioned to draw air from around the IRU through the secondary heat exchangers.



OPERATIONS MANUAL

The malfunction warning control circuits combine signals from the IRU, IRUE, and computer to produce signals which control warning flags and lamps. Hardware monitors in the IRU and IRUE detect abnormal operation of temperature control circuits (overtemperature), gyro stabilization circuits, accelerometer circuits, and attitude synchro circuits. Hardware monitors within the computer detect abnormal operation of the computer while reasonableness tests on computer and input data detect out-of-tolerance conditions.

Detection of an overtemperature will shut the INS down automatically whenever the MSU mode selector is set to STBY or ALIGN. When it is set to NAV or ATT, an overtemperature will produce a warning indication on the C/DU but the INS will not automatically shut down. The battery unit is tested during the alignment mode of operation and the INS will automatically shut down if the battery unit charge is low when this test is accomplished. In addition, the INS will shut down any time that a low battery unit voltage is detected while the INS is operating on battery unit power.

During the attitude mode of operation, the computer is shut down and attitude stabilization signals and attitude warning flag control signals are the only outputs of the INS. The IRU horizontal accelerometers are used to sense platform tilt in a manner similar to the alignment mode of operation. The acceleration signals in this mode of operation are converted in the IRUE to provide control signals which maintain the platform at the horizontal reference.

MODE SELECTOR UNIT (MSU)

The MSU contains a mode selector and two indicating lamps mounted on an illuminated panel. Panel lettering illumination intensity is controlled by a cabin lighting control. Refer to figure 108 for descriptions of the mode selector and lamps.

MODE SELECTOR

The mode selector controls operating modes of the INS. The knob must be pulled for rotation across mechanical stops between STBY and ALIGN and between NAV and ATT.



OFF - The INS is inoperative when the mode selector is at the OFF position.

STBY - The STBY (standby) position is used only during ground operation. Setting the mode selector to STBY from OFF starts fast warmup in the NU, cages the IRU to the orientation of the airplane, starts the gyro wheels spinning, turns on the computer, and turns on the C/DU so that information can be inserted into the computer. When



OPERATIONS MANUAL

STBY is selected from any other position, the IRU is not caged but operates the same as during the attitude mode of operation.

ALIGN - The ALIGN (alignment) position is normally used only during ground operation while the airplane is parked. Setting the mode selector to ALIGN from STBY will start automatic INS alignment providing the fast warmup heaters have shut off. Fine alignment will not be started until present position has been inserted at the C/DU. The computer automatically cycles through leveling alignment. The ALIGN position can be selected from the OFF position, but leveling will not be started until the fast warmup heaters are shut off. Moving the mode selector to ALIGN from NAV will not downmode the INS but will allow automatic shutdown if an overtemperature is detected.

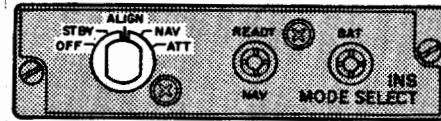

NAV - The NAV (navigation) position is used for normal operation after automatic alignment has been completed. The NAV position must be selected before moving the airplane. The INS will automatically sequence through standby and alignment operation to the navigation mode of operation when the NAV position is selected from the STBY position providing that present position is inserted and the airplane is parked.

ATT - The ATT (attitude) position is used to provide only INS attitude signals. This position shuts down the computer so that navigation and steering signals are not provided. The C/DU is also shut down and only the BAT and WARN lamps are operative. The ATT position can be selected from any other position. Once the ATT position is selected, the INS alignment is lost and the INS has to be realigned on the ground before the navigation mode of operation can again be used.

BAT LAMP

The BAT (battery) lamp lights only when the INS has automatically shut down due to a low battery unit voltage. The INS will automatically shut down before the battery unit is completely discharged. A shutdown due to low battery unit voltage can only occur while the INS is operating on battery unit power. The

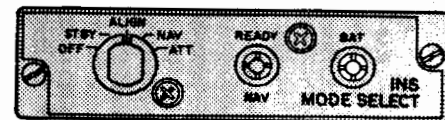

Mode Selector Unit (Sheet 2 of 3)

Figure 108



OPERATIONS MANUAL

INS operates on battery power for a short period during coarse leveling. If the battery unit charge is below the required minimum level during this period, the INS will shut down and the BAT lamp will light to indicate the reason.

READY NAV LAMP

The READY NAV (ready to navigate) lamp lights when the desired alignment status of the INS is attained. When alignment is accomplished with the mode selector at ALIGN, the READY NAV lamp remains lighted until NAV is selected. The READY NAV lamp lights momentarily when alignment is accomplished with the mode selector at NAV.



Mode Selector Unit (Sheet 3 of 3)
Figure 108

CONTROL/DISPLAY UNIT (C/DU)

The C/DU contains controls, indicators, and displays for manually inserting information into the INS and for displaying navigation information and system status information. Logic circuits in the C/DU convert manual control operations into digital data signals and decode digital data signals for display. Refer to figure 109 for descriptions of controls, displays, and indicators.

DATA DISPLAYS

The data displays are composed of lamps which indicate numbers, decimal points, degree symbols, left and right directions, and latitude or longitude directions. The data to be displayed is primarily selected by the eight position data selector. Data to be inserted into the computer is first loaded into the data displays by operating the keyboard. Display of the loaded data allows visual verification before inserting it into the computer. Pressing the INSERT key inserts the loaded data into the computer memory and the computer then resumes control of the data displays.

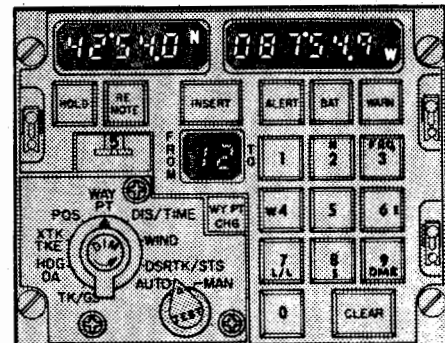

Control/Display Unit (Sheet 1 of 10)
Figure 109



OPERATIONS MANUAL

KEYBOARD

The keyboard consists of 10 keys which are used to load data into the data displays and FROM-TO display. The N, S, W, and E on keys 2, 8, 6, and 4 indicate direction of latitude and longitude. The FRQ, L/L, and DME on keys 3, 7, and 9 are associated with the insertion of DME station data. The lettering FRQ, L/L, and DME on keys 3, 7, and 9, are useful but not mandatory, therefore, CIV CDU's can be used with CIV-A systems. Keyboard illumination is controlled by a cabin lighting control.

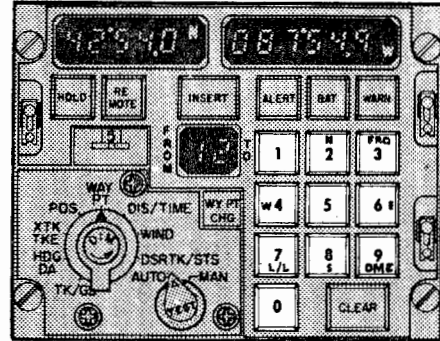

CLEAR KEY

The CLEAR key is used to cancel a data loading operation when erroneous data is inadvertently loaded into the data displays or the FROM-TO display. When the CLEAR key is pressed during a loading operation, the computer resumes control of the applicable display and the loading operation can be restarted. The CLEAR key illumination intensity is controlled by the same cabin lighting control as the keyboard.

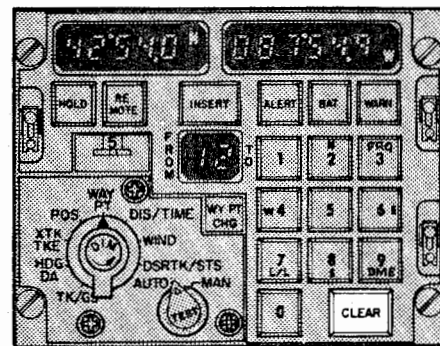

INSERT KEY

The INSERT key is used to insert loaded data into the computer. It normally lights while data is being loaded through the keyboard and goes out either when the data is inserted by pressing the INSERT key or when the CLEAR key is pressed.

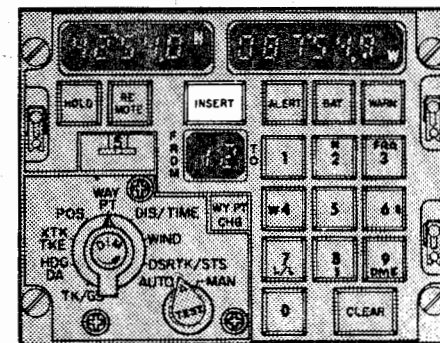



OPERATIONS MANUAL

DATA SELECTOR

The data selector has eight positions for selecting data to be displayed in the data displays. Three of these positions (POS, WAY PT, and DSRTK/STS) also allow data to be loaded into the data display and then inserted into the computer memory. The illuminated panel under the data selector is controlled by the same cabin lighting control used for the keyboard and CLEAR key.

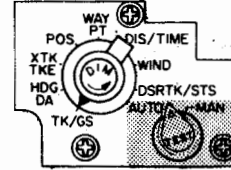

TK/GS - Present track angle and ground speed are indicated in the data displays when the data selector is set to TK/GS. Present track angle is displayed from 0 to 359.9 degrees in the left-hand data display to the nearest tenth of a degree with respect to true north. Ground speed is displayed from 0 to 2,400 knots in the right-hand data display to the nearest knot. True heading is displayed in place of present track angle when ground speed is below 75 knots. The INS indicates a malfunction if the displayed ground speed is 910 knots or greater.

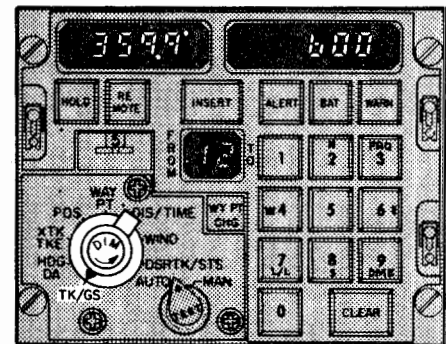

HDG/DA - Airplane heading and drift angle are indicated in the data displays when the data selector is set to HDG/DA. Heading is displayed from 0 to 359.9 degrees in the left-hand data display to the nearest tenth of a degree with respect to true north. Drift angle is displayed from 0 to 180 degrees right or left of the airplane heading in the right-hand data display to the nearest degree. The displayed drift angle is 0 degrees when ground speed is below 75 knots. The INS indicates a malfunction if the displayed drift angle is 45 degrees or greater.

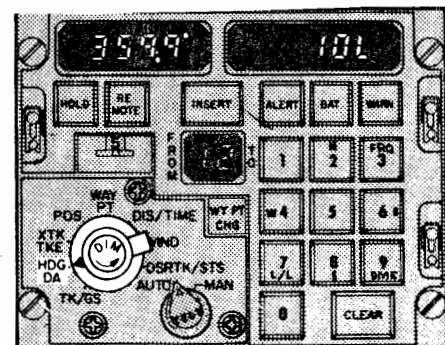

Control/Display Unit (Sheet 3 of 10)
Figure 109



OPERATIONS MANUAL

DATA SELECTOR (CONT)

XTK/TKE - Cross track distance and track angle error are indicated in the data displays when the data selector is set to XTK/TKE. Cross track distance is displayed from 0 to 999.9 nautical miles right or left of the desired track in the left-hand data display to the nearest tenth of a nautical mile. Track angle error is displayed from 0 to 180 degrees right or left of the desired track angle in the right-hand data display to the nearest degree. The angle between desired track angle and heading is displayed in place of track angle error when ground speed is below 75 knots.

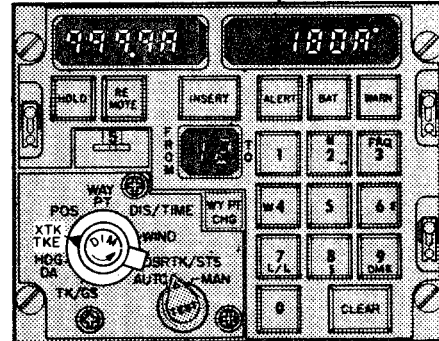

POS - Present position of the airplane is displayed in the data displays when the data selector is set to POS. Latitude is displayed in the left-hand data display and longitude is displayed in the right-hand data display. Both data displays indicate degrees and minutes to the nearest tenth of a minute. This position is also used in inserting present position coordinates during alignment and position updates. The data displays, after INS turnon but before present position is inserted, will display the calculated position at the preceding INS shutdown when the data selector is at POS.

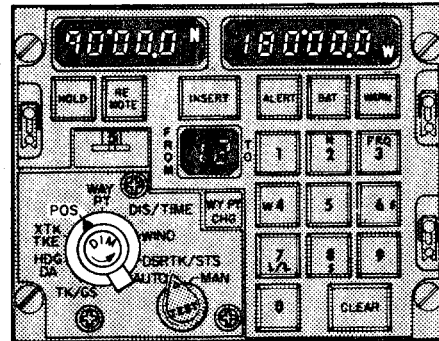



OPERATIONS MANUAL

DATA SELECTOR (CONT)

WAY PT - The WAY PT position, in conjunction with the waypoint/DME selector, allows waypoint and DME station data to be inserted and displayed. Prior to the first insertion after turn-on, the data displays will display 0's for all waypoints, but will display the last DME station data which was inserted during the previous flight. The WAY PT position is also used to display inertial present position when HOLD is illuminated. Latitude and longitude are loaded and displayed in degrees and minutes to the nearest tenth of a minute. DME altitude is in feet and is rounded off to the nearest thousand feet. The range is from sea level (0) to 15,000 feet. DME station frequency ranges from 108.00 to 135.95 MHz and is displayed in the format XX^oXX.X. For example, a frequency of 117.50 MHz is displayed as 11^o75.0.

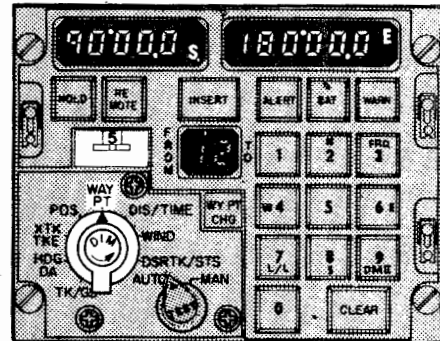

DIS/TIME - Either the distance to any DME station or the distance and time to any waypoint or between any two waypoints can be displayed using the DIS/TIME position. The time is based on the present ground speed. The selection of a DME station for a distance display blanks the time display. Distance is displayed from 0 to 9999 nautical miles in the left-hand data display to the nearest nmi. The displayed value of time is set to the maximum value (999.9 minutes) when ground speed is below 10 knots.

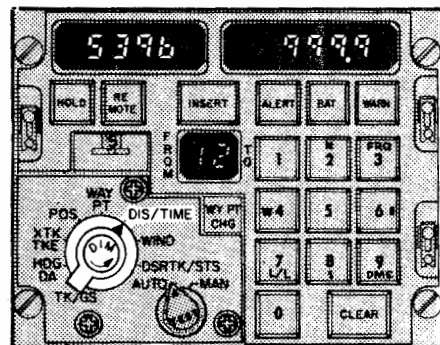

WIND - Wind direction and speed are indicated in the data displays when true airspeed is larger than the lower stop setting of the Air Data Set and the data selector is set to WIND. Wind direction is displayed from 0 to 359 degrees in the left-hand data display to the nearest degree. Wind speed is displayed from 0 to 606 knots in the right-hand data display to the nearest knot. Both wind direction and wind speed are indicated at 0 when airspeed is at the lower stop setting of the Air Data Set. An airspeed signal exceeding 606 knots or a malfunction warning from the central air data computer also causes both displays to indicate 0.

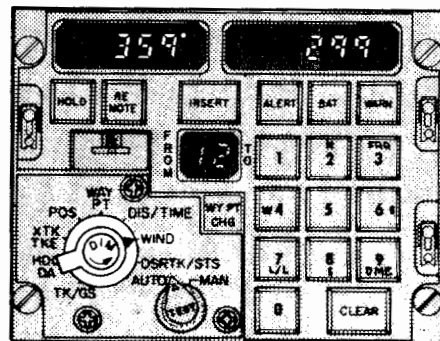

Control/Display Unit (Sheet 5 of 10)
Figure 109



OPERATIONS MANUAL

DATA SELECTOR (CONT)

DSRTK/STS - Desired track angle to the nearest degree is displayed in the left-hand data display.

NOTE: In latter programs (CIV-A-20 and on), at turn-on the left-hand data display will show a partial program P/N as a program identifier, until present position has been loaded, as follows:

Program	LH Display
CIV-A-20	11-05
CIV-A-21	11-06
CIV-A-II-20	12-02
CIV-A-HHS-20	20-01

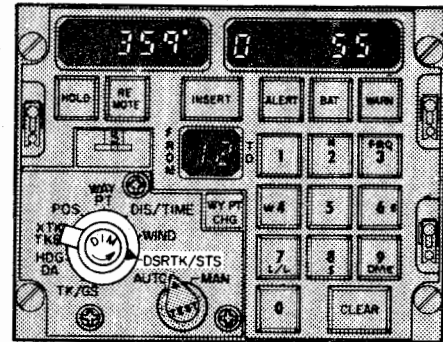

NOTE: See page 1 for additional programs.

The right-hand data display indicates system status. During normal operation, only three of the six digits are lighted.

The first digit, which is always present, indicates whether the INS is in Nav (1) or if it is in either Align or Standby (0). This digit is a true indication of the INS operating mode and does not necessarily agree with the setting of the mode selector on the MSU. For example, if the mode selector is moved directly from STBY to NAV, this digit will not go from 0 to 1 until the alignment process is complete and the INS actually enters the Nav mode. Similarly, returning the mode selector to ALIGN after Nav mode has been attained will not change this digit from 1.

The second and third digits light only when a malfunction occurs. These numbers are called action and malfunction codes and are explained in Section 3.

The fifth digit (called the displayed PI number) indicates the computer mode number during the align mode (see page 111). During NAV (for CIV-A-21) the number will range from 0 to 9 and is indicative of predicted navigation performance. This digit is forced to 0 when NAV is entered and progresses toward 9 as time in NAV increases. If a DME update is performed, the number decreases toward 0 but will not go below 2 if altitude data is invalid. This fifth digit is sometimes called the Accuracy Index number (AI number) (see page 227).

The sixth digit is set to "5" during ALIGN and cannot be changed. In NAV, this digit sometimes referred to as the "desired PI number" indicates the pilot selected operating mode and is a number ranging from 0 to 5. See page 227 for a more detailed discussion. In a multiple INS installation, each INS can be operated independently in its own mode (PI = X) without reference to the other systems modes.



OPERATIONS MANUAL

WAYPOINT/DME SELECTOR

The waypoint/DME selector is used to select the waypoints and DME stations for which data is to be inserted or displayed. The coordinates displayed when the waypoint/DME selector is set to 0 are normally those of the original departure point inserted at the time of alignment. In addition, any manually induced course change of the X to Y variety results in the coordinates of the point of leg change being inserted into waypoint 0.

NOTE: Data for DME station 0 cannot be loaded. DME station 0 displays the data loaded for station 1.

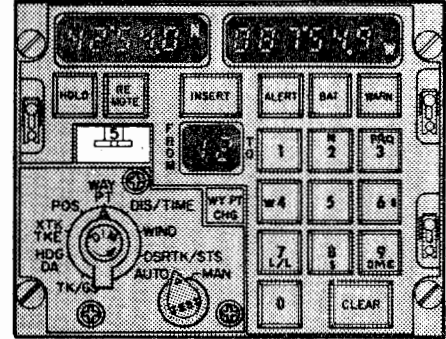

FROM-TO DISPLAY

The numbers in the FROM-TO display indicate either the waypoints defining the navigation leg currently being flown or the DME station currently being used. The number identifying a DME station flashes on and off in the TO side of the display while the FROM side goes blank. The waypoint numbers identifying navigation legs automatically change each time a waypoint is reached. Unless the flight plan is changed during a flight, the automatic switching sequence will always be 1 2, 2 3, 3 4, . . . 8 9, 9 1, 1 2, etc.

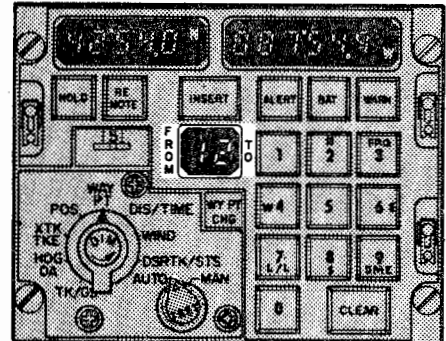

WYPT CHG KEY

Pressing the WY PT CHG key allows the numbers in the FROM-TO display to be changed. If the INSERT key is pressed, the computer will use the navigation leg or DME station defined by the new numbers in all navigation computations. If the INSERT key is not pressed, the computer will continue to use the original numbers in all navigation computations, but distance/time information based on the new leg can be called up and read in the data displays.

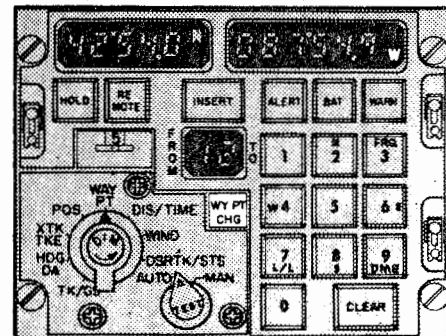

Control/Display Unit (Sheet 7 of 10)
Figure 109



OPERATIONS MANUAL

HOLD KEY

The HOLD key is used in conjunction with other C/DU controls to freeze displayed present position, to perform manual position updates, and to display inertial present position.

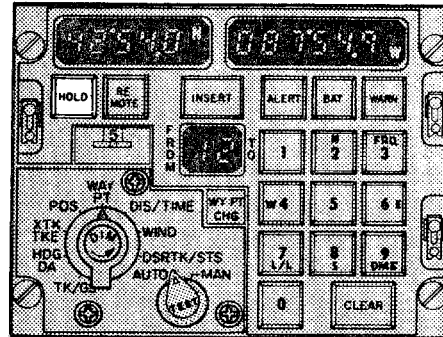

WARN LAMP

The WARN lamp lights red when the INS detects an out of tolerance condition in the INS, an operator error, or an error in the data received from an ADEU. Illumination of the WARN lamp can be caused by a continuous or intermittent condition. Intermittent out-of-tolerance conditions detected by the computer light the WARN lamp until it is reset by the TEST switch. If the WARN lamp is lighted by a continuous condition which does not degrade attitude operation, the WARN lamp goes out when the mode selector is set to ATT.

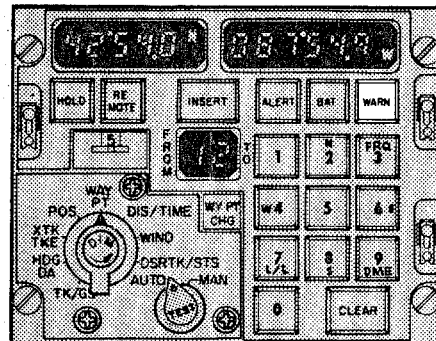

TEST SWITCH

The TEST switch is used to test all INS lamps and displays, several remote lamps and indicators controlled by the INS, and computer input/output operations. The TEST switch is also used in conjunction with other controls to display numerical codes indicating specific malfunctions and to reset the malfunction warning circuits.

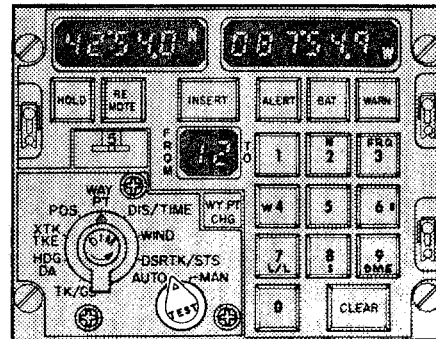



OPERATIONS MANUAL

REMOTE KEY

The REMOTE key lights amber when pressed and allows simultaneous loading and insertion of way-point and navaid data into more than one INS by using only one C/DU. The REMOTE key must be pressed on all participating INS to achieve this simultaneous insertion. The remote operation is disabled when the REMOTE keys are again pressed and the key light goes out. A delay from 0 to 1.2 seconds can be expected in transferring remote data from one INS to another.

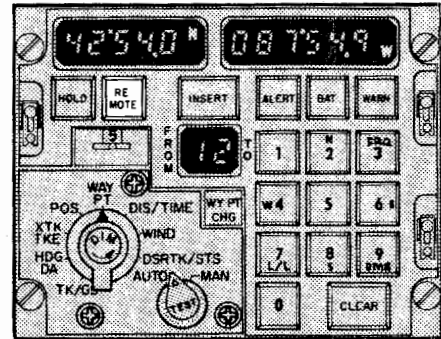

AUTO-MAN SWITCH

The AUTO-MAN switch is used to select either automatic or manual navigation leg switching. In automatic, the computer switches from one leg to the next whenever the waypoint in the TO side of the FROM-TO display is reached. In manual, the pilot must initiate the switch to the next leg manually.

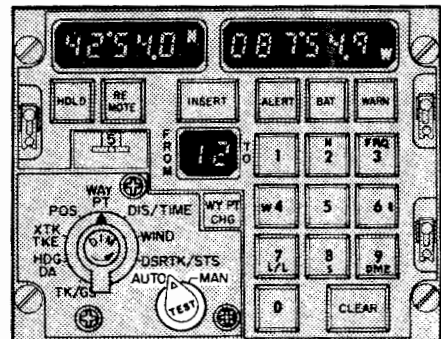



OPERATIONS MANUAL

ALERT LAMP

The ALERT lamp lights amber two minutes before reaching a waypoint during flight. The light goes out when the INS automatically switches to the next navigation leg. The ALERT lamp flashes on and off after passing a waypoint if the AUTO-MAN switch is in MAN. In this case, the light goes out when either AUTO is selected or a course change is inserted. To avoid having the ALERT light flash during landing, the computer will not allow it to light when ground speed is below 250 knots.

NOTE: In a multiple installation, each INS calculates the time to light ALERT based on its estimate of distance to go and ground speed. Consequently, the ALERT indicator may light at slightly different times for each INS.

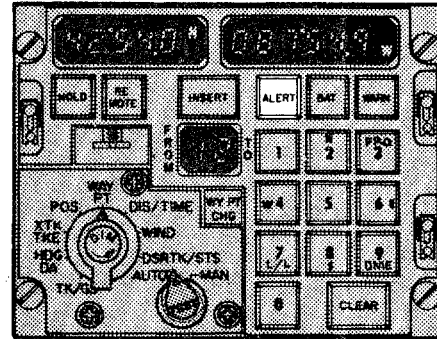

NOTE: The ALERT indicator will flash with the AUTO-MAN switch in the AUTO position provided the flight leg is less than 25.6 sec and the aircraft has flown past the TO waypoint.

BAT LAMP

The BAT lamp lights amber when the INS is operating on battery power.

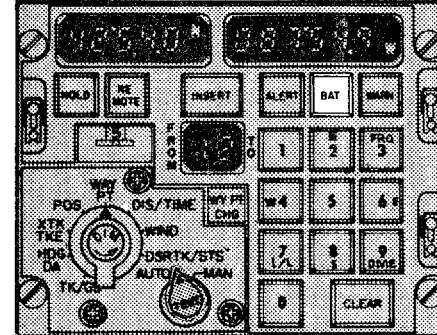

DIM KNOB

The DIM knob on the data selector is used to vary light intensity of the data displays, the FROM-TO display, the ALERT lamp, and the HOLD, REMOTE, INSERT, and WY PT CHG keys.

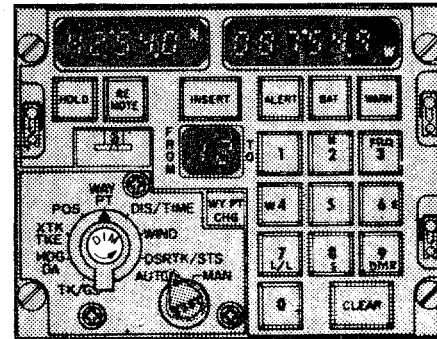



OPERATIONS MANUAL

SECTION 2

NORMAL OPERATING PROCEDURES

INTRODUCTION

Detailed procedures for operating the INS are contained in figures 201 through 217, indexed below. Brief discussions of each procedure, also indexed below, are presented in the pages following the last procedure. Detailed descriptions of the functions of all MSU and C/DU controls and indicators are contained in figures 108 and 109. A discussion of the computer modes can be found on pages 105, 111, and 112.

	Procedure	Discussion
Recommended Preflight Procedures	Figure 201	None
Present Position Insertion	Figure 202	Page 228
Manual Insertion of Waypoint Coordinates	Figure 203	Page 228
Manual Insertion of DME Station Data	Figure 204	Page 228
Data Insertion Using ADEU	Figure 205	Page 228
Obtaining Aided Inertial Operation	Figure 206	None
Switching From Aided to Unaided Inertial Operation	Figure 207	None
Display Present Inertial Position	Figure 208	Page 229
Present Position Check and Update	Figure 209	Page 229
Position Update Eradication	Figure 210	Page 229
Manual Flight Plan Change Insertion	Figure 211	Page 229
Use of Data Displays	Figure 212	None
Distance and Time to Waypoint Other than Next Waypoint	Figure 213	None
Distance and Time Between Any Two Waypoints	Figure 214	None
Distance to DME Station	Figure 215	None
Latitude and Longitude of Any Waypoint	Figure 216	None
DME Data	Figure 217	None
Verification of Flight Plan Data	Figure 218	None
Heading Hold/Select Mode (CIV-A-HHS-20 Program)	Figure 219	None
Interpretation of STS Display	Figure 220	Page 232
Remote Operation	None	Page 230
Discussion of Aided Inertial Operation	None	Page 230
Discussion of "Desired PI" Number	None	Page 231
After Landing Procedures	None	Page 233/234



OPERATIONS MANUAL

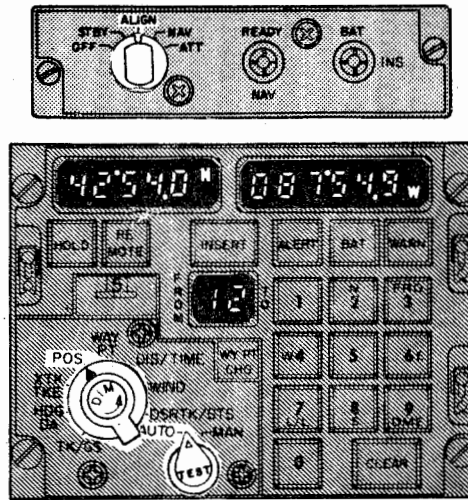

1. Check that power is available and all applicable circuit breakers are engaged.

CAUTION: INSURE THAT COOLING AIR IS AVAILABLE TO NAVIGATION UNIT BEFORE TURNING INS ON.

2. Set mode selector to ALIGN.

(FROM-TO display indicates 1 2. INSERT key lights. BAT lamp on C/DU will light for 12.8 seconds starting when computer mode 8 is entered.)

NOTE: Airplane must not be towed or taxied during INS alignment. Movement of that type during alignment causes large navigation errors. If the airplane is moved during alignment, restart alignment by setting mode selector to STBY, then back to ALIGN, and reinserting present position. Motion of the type caused by passenger or cargo loading has no effect other than to possibly slow the alignment process slightly.

3. Adjust DIM knob for optimum brightness of C/DU displays.
4. Set AUTO-MAN switch to AUTO.
5. Set data selector to POS.

(Coordinates of last present position prior to INS turn-off appear in data displays.)

6. Press and hold TEST switch.

(Left-hand and right-hand data displays indicate $88^{\circ}88.8^{\text{N}}$ and $888^{\circ}88.8^{\text{W}}$, respectively.

FROM-TO display indicates 8 8.

Following keys and lamps light: REMOTE, HOLD, INSERT, WY PT CHG, ALERT, BAT (on both C/DU and MSU), WARN, and READY NAV.)



OPERATIONS MANUAL

7. Release TEST switch.

(Data displays indicate coordinates in computer memory. All lamps and keys lighted in step 6 except INSERT key go out.)

8. Set data selector to DSRTK/STS.

(Left-hand data display indicates "XX-XX" (where XX-XX is partial program P/N-see page 1) until present position is loaded, and then it displays desired track angle in computer memory. Right-hand data display indicates 0---95, 0---85, 0---75, 0---65, or 0---55, depending on which mode the computer has reached.)

9. Insert present position as described in figure 202.

NOTE: Computer will not advance to mode 6 until present position has been inserted. Once present position has been inserted and the computer has advanced to mode 7, present position can not be reinserted without downmoding to Standby and restarting alignment.

NOTE: The following two steps are optional but strongly recommended to ensure that present position has been properly loaded.

- 9.1 Insert waypoint position 2 as described in figure 203.

- 9.2 Verify distance (figure 214) between waypoint position 0 (which is the loaded present position) and waypoint position 2.

10. Insert and verify waypoint positions as described in figure 203 (manual) or 205 (ADEU).

11. Insert and verify DME station latitude, longitude, altitude, and frequency as described in figure 204 (manual) or 205 (ADEU).

12. Observe that READY NAV lamp lights when computer enters mode 5.

13. Mode Selector may now be set to NAV at operator's discretion.

(READY NAV lamps goes out.)

NOTE: Remaining in align until just prior to roll back will minimize pre-flight NAV time and error buildup.

NOTE: Do not pull mode selector when switching to NAV. This prevents overshooting to the ATT position, which would destroy the alignment. If ATT is selected, alignment must be restarted by setting the mode selector to STBY, then back to ALIGN and reinserting present position.

14. Set data selector to DSTRK/STS. Leftmost digit of right-hand display should be a 1 indicating that the INS is in the NAV mode.

NOTE: In a three INS installation, it is recommended that a PI = 4 be inserted after NAV has been selected and that it be left unchanged for the duration of the flight in order to have the benefit of three system mixing throughout the flight. See figure 206, steps 1 through 5 for procedure to be used.



OPERATIONS MANUAL

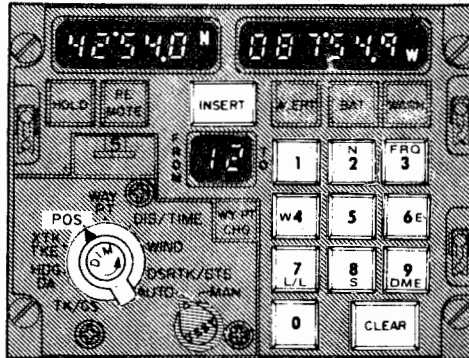

NOTE: Prior to pressing the INSERT key, any incorrectly loaded data can be corrected by pressing the CLEAR key and loading the correct data.

1. Insure that data selector is set to POS and that INSERT key is lit.
(INSERT key remains lit and loaded latitude is displayed.)
2. Load latitude by pressing keyboard keys in sequence, starting with N or S to indicate North or South. Example: 42°54.0' North = N 4 2 5 4 0.
(Latitude appears in left hand data display as keys are pressed.)
3. Press INSERT key.
(INSERT key remains lit and loaded latitude is displayed.)
4. Load longitude by pressing keyboard keys in sequence, starting with W or E to indicate West or East. Example: 87°54.9' West = W 8 7 5 4 9.
(Longitude appears in right hand data display as keys are pressed.)
5. Press INSERT key.
(INSERT key goes out and loaded longitude is displayed.)

NOTE: If C/DU WARN indicator lights immediately after completion of step 5, check if correct present position has been loaded. Reload if required. Rotate data selector to DSTRK/STS and observe if action code 04 and malfunction code 41 are present. Clear by pressing TEST switch. (See Abnormal Procedures section if other action and malfunction codes are present.)

Present Position Insertion
Figure 202



OPERATIONS MANUAL

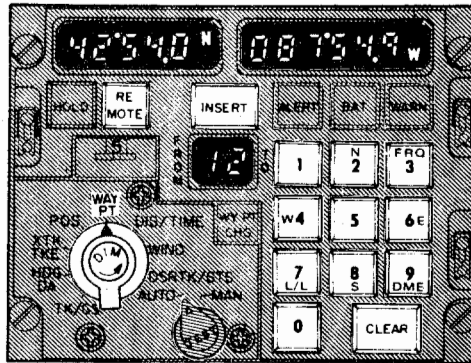

1. Set data selector to WAY PT
(Data displays indicate 0 if this is first insertion into selected waypoint since turn-on. Otherwise, data displays indicate last coordinates inserted into selected waypoint.)
2. To insert the waypoint coordinates into all INS simultaneously, press REMOTE key on each INS.
(REMOTE key lights if pressed.)
3. Set waypoint/DME selector to number of waypoint to be loaded.

NOTE: Insure that waypoint/DME selector is in detent.

4. Load latitude by pressing keyboard keys in sequence, starting with N or S to indicate North or South. Example: 42°54.0' North = N 4 2 5 4 0.
(INSERT key lights when first key is pressed, and latitude appears in left-hand data display as keys are pressed.)
5. Press INSERT key.
(INSERT key goes out and loaded latitude is displayed.)
6. Load longitude by pressing keyboard keys in sequence, starting with W or E to indicate West or East. Example: 87°54.9' West = W 8 7 5 4 9.
(INSERT key lights when first key is pressed, and longitude appears in right-hand data display as keys are pressed.)
7. Press INSERT key.
(INSERT key goes out and loaded longitude is displayed.)
8. Repeat steps 3 through 7 for each waypoint to be loaded.
9. Verify INS acceptance of all waypoint data in accordance with figure 218. If waypoint data does not verify correctly, reload waypoint data in the reverse direction, i.e., rotate waypoint/DME selector one position higher than the waypoint to be corrected and then back to the desired position, e.g., if waypoint 9 is to be corrected, rotate to position 0 and back to 9.

Manual Insertion of Waypoint Coordinates

Figure 203



OPERATIONS MANUAL

← Loaded latitude and longitude

Loaded altitude and frequency →

NOTE: Prior to pressing the INSERT key, any incorrectly loaded data can be corrected by pressing the CLEAR key and loading the correct data.

1. Set data selector to WAY PT.
2. To insert DME station data in all INS simultaneously, press REMOTE key on each INS.
(REMOTE keys light when pressed.)
3. Set waypoint/DME selector to number of the DME station to be loaded.
NOTE: Insure that waypoint/DME selector is in detent.
4. Simultaneously press keyboard keys 7 and 9.
(FROM portion of FROM-TO display goes blank. Number of DME station being used for navigation flashes on and off in TO portion. Data displays indicate last coordinates inserted.)
NOTE: If the number of the new station to be loaded is the same as the number of the DME station currently being used, the number in the TO display will be set to 0 when DME data is loaded and DME updating on that station is terminated. The number in the TO display will also be 0 if no DME station has been selected for navigation or if the designated station has not met DME reasonableness tests for >2.5 min. (See fig 206-15.)
5. Load latitude by pressing keyboard keys in sequence, starting with N or S to indicate North or South. Example: 42°54.0' North = N 4 2 5 4 0.
(INSERT key lights when first key is pressed, and latitude appears in left-hand data display as keys are pressed.)
6. Press INSERT key.
(INSERT key goes out and loaded latitude is displayed.)
7. Load longitude by pressing keyboard keys in sequence, starting with W or E to indicate West or East. Example: 87°54.9' West = W 8 7 5 4 9.
(INSERT key lights when first key is pressed, and longitude appears in right-hand data display as keys are pressed.)

Manual Insertion of DME Station Data (Sheet 1 of 2)
Figure 204



OPERATIONS MANUAL

8. Press INSERT key.
(INSERT key goes out and loaded longitude is displayed.)
9. Simultaneously press keyboard keys 3 and 9.
(Data displays indicate last previously inserted altitude and frequency.)
10. Press keyboard key 2 or 8 to indicate following load is altitude.
(INSERT key lights.)
11. Round off DME station altitude to nearest 1,000 feet and load the number of thousands by pressing keyboard keys in sequence. Examples: 6,600 feet = 7,000 feet = 7. 12,300 feet = 12,000 feet = 12.
(Numbers appear in left-hand data display as keys are pressed.)

NOTE: Only numbers 0 thru 15 are accepted by the INS.
12. Press INSERT key.
(INSERT key goes out and loaded altitude is displayed.)
13. Press keyboard key 4 or 6 to indicate that following load is frequency.
(INSERT key lights.)
14. Load frequency by pressing five keyboard keys in sequence.
Example: 117.50 MHz = 1 1 7 5 0.
(Frequency appears in right-hand data display as keys are pressed. Display is in longitude format; for example, 117.50 MHz appears as 11⁰75.0.)

NOTE: Only frequencies from 108.00 to 135.95 MHz are accepted by the INS.
15. Press INSERT key.
(INSERT key goes out and loaded frequency is displayed.)
16. Repeat steps 3 thru 15 for each DME station.
17. Verify INS acceptance of all DME station data in accordance with figure 218. If DME station data does not verify correctly, reload DME station data in the reverse direction, i.e., rotate waypoint/DME selector one position higher than the number of the DME station data to be corrected and then back to the desired position, e.g., if station 9 is to be corrected, rotate to position 0 and back to 9.
18. To return the INS to normal operation, momentarily set data selector to any position other than WAY PT and DIS/TIME.



OPERATIONS MANUAL

1. Insure that INS is in standby mode or higher.
2. To insert data in all INS simultaneously, press REMOTE key on each INS, and insure that all INS are using the same navigation leg.
(REMOTE key lights if pressed.)
3. Insert nav aid card into card insertion slot of ADEU. The coded side of the card must be facing up and the heavy black line on the left.
(READ light on ADEU comes on as card is taken into ADEU and goes out when reading is complete.)
4. Remove card from ADEU.
NOTE: If necessary, the ADEU can be restarted by pressing the AUX START button.
NOTE: The ERROR lamp on the ADEU will light if the ADEU detects a card read error. Before starting another card read operation, the ERROR lamp must be pressed and put out.
5. Monitor C/DU WARN indicator which will light if the data from the ADEU fails a reasonableness test. Set data selector to DSTRK/STS if WARN indicator is lit and verify that action code 05 with malfunction code 55 are present. Malfunction code 55 should be cleared and the card reinserted. (See Abnormal Procedures section if other action and malfunction codes are present.)
NOTE: Issuance of malfunction code 55 may not occur for up to 12 seconds after navaid card is inserted.
6. Verify INS acceptance of flight plan data in accordance with figure 218.

**DME And Waypoint Data Insertion Using Automatic Data Entry Unit
Figure 205**

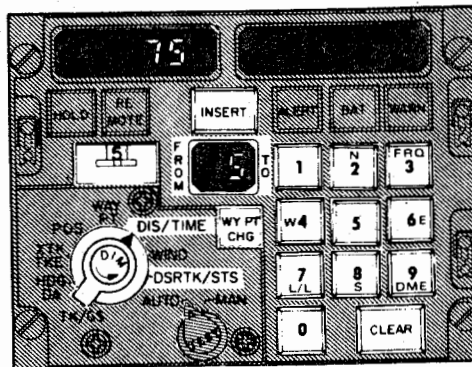

NOTE: If three INS are present and no DME stations are available, perform only steps 1 thru 5.

1. Insure that INS is in Nav mode.

**Obtaining Aided Inertial Operation (Sheet 1 of 2)
Figure 206**



OPERATIONS MANUAL

2. Set data selector to DSRTK/STS.
(If 1 ---X4 is displayed in right-hand data display, proceed directly to step 5.)
3. Press keyboard key 4. Ensure that 000004 appears in right-hand data display and that INSERT key is lit before proceeding to next step.
4. Press INSERT key.
(INSERT key goes out. Data displays return to normal with 4 appearing in last digit of right-hand display.)
5. Repeat steps 1 thru 4 for each INS for which aided inertial operation or triple INS mixing is desired.
6. Tune DME to selected DME station.
7. Set data selector to DIS/TIME.
8. Set waypoint/DME selector to number of selected DME station.
9. Simultaneously press keyboard keys 7 and 9.
(FROM side of FROM-TO display goes blank. Number of last previously selected DME station flashes on and off in TO side.)
10. Verify that distance to selected DME station as displayed in left-hand data display agrees approximately with the corresponding DME reading on the DME indicator.
11. Press WY PT CHG key.
(WY PT CHG and INSERT keys light and TO side of FROM-TO display stops flashing.)
12. Press keyboard key corresponding to number of selected DME station.
(Number of selected DME station appears in TO side of FROM-TO display.)
13. Press INSERT key.
(INSERT and WY PT CHG keys go out and TO side of FROM-TO display flashes on and off.)
14. If second DME station is available, repeat steps 6 thru 13 on second INS, then proceed to step 15. If second DME station is not available, proceed directly to step 15.
15. Monitor DME MIXING IN PROGRESS indicator (if part of aircraft installation). Indicator will light approximately 12 seconds after station designation (see step 13) if data from selected DME station passes reasonableness tests.
16. Monitor TO side (station designator) of FROM-TO display if there is no DME MIXING IN PROGRESS indicator or if indicator does not light. Station designator will be set to zero if INS is receiving data directly from a DME station and either one of the following conditions occur.
 - a. The data does not meet range rate requirements within 2.5 minutes after station designation.
 - b. The calculated distance to the DME station is less than 250 nmi and the difference between the calculated distance and the DME range data does not meet delta range requirements within 2.5 minutes with single DME updating or 5 minutes with dual DME updating.

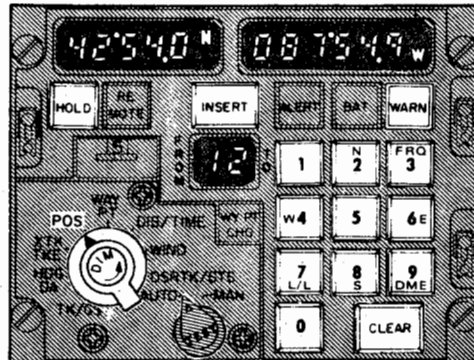
OPERATIONS MANUAL

PRESENT POSITION CHECK

1. Insure that INS is in Nav mode and not in the Position Update Eradicate mode. (Position Update Eradicate mode is indicated by 1 in last digit of right-hand data display when data selector is set to DSRTK/ STS.)
2. Set data selector to POS.
(Latitude and longitude of present position appear in left-hand and right-hand data displays, respectively.)
3. Press HOLD key when aircraft passes over known position reference.
(HOLD key lights. Latitude and longitude in data displays freeze at values present when HOLD key was pressed.)

NOTE: If more than one INS is being checked and updated, the HOLD keys on all INS should be pressed simultaneously.

4. Compare displayed latitude and longitude with latitude and longitude of position reference. If displayed values are within tolerance, press HOLD key to return the INS to normal operation. If one or both values are out of tolerance, proceed to step 5.

PRESENT POSITION UPDATE

5. To insert data in two or more INS simultaneously, press REMOTE key on each INS.
(REMOTE key lights if pressed.)
6. Load latitude of position reference by pressing keyboard keys in sequence, starting with N or S to indicate North or South. Example: 42°54.0' North = N 4 2 5 4 0.
(INSERT key lights when first key is pressed, and latitude appears in left-hand data display as keys are pressed.)
7. Press INSERT key.
(INSERT key remains lit.)

Present Position Check And Update (Sheet 1 of 2)
Figure 209



OPERATIONS MANUAL

8. Load longitude of position reference by pressing keyboard keys in sequence, starting with W or E to indicate West or East. Example: 87°54.9' West = W 8 7 5 4 9.

(Longitude appears in right-hand data display as keys are pressed.)

9. Press INSERT key.

(INSERT and HOLD keys go out. Present position appears in data displays. Present position check and update is complete.)

NOTE: If HOLD key does not go out, WARN lamp lights, and data displays continue to display position reference coordinates, proceed to step 10.

FORCED UPDATE OF PRESENT POSITION

10. Verify that position reference coordinates displayed in data displays are correct. If either is in error, repeat steps 6 thru 9, and then proceed to step 12. If both coordinates are correct and it is desirable to force the INS to accept them, proceed to step 11.

11. Press HOLD key.

(HOLD key goes out. New present position appears in data displays. WARN lamp remains lit.)

NOTE: Corrections greater than a few degrees are not effective even though the HOLD key goes out when pressed. The displayed present position, then, will reflect only the part of the correction that was accepted. This procedure should not be used to correct for errors in loading ramp coordinates.

12. Set data selector to DSRTK/ STS.

(Action code 02 appears in 2nd and 3rd digits in right-hand data display.)

13. Press and release TEST switch.

(Malfunction code 49 appears in place of action code 02.)

NOTE: Malfunction code 49 indicates that position update correction was larger than 33 nautical miles. If any other malfunction code appears, take corrective action outlined in Section 3.

14. Press and release TEST switch.

(WARN lamp goes out. 2nd and 3rd digits of right-hand data display go blank.)



OPERATIONS MANUAL

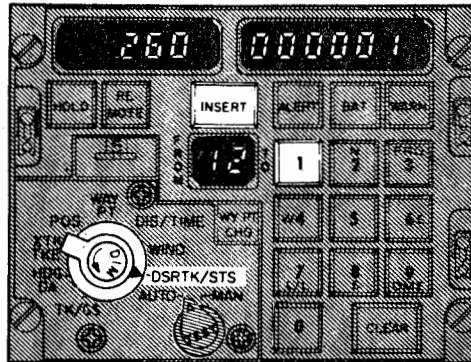

NOTE: This procedure is not considered a common procedure. Its use is limited to those times where an operational error has resulted in an erroneous position fix.

1. Set data selector to DSR TK/STS.
2. Press keyboard key 1. Ensure that 000001 appears in right-hand data display and that INSERT key is lit before proceeding to next step.
3. Press INSERT key.

(INSERT key goes out. Data displays return to normal with 5 in last digit of right-hand display.)

NOTE: The INS is automatically reset to PI = 5 at completion of step 3 and is now in the normal inertial operation with all previous fixes (whether from a manual update, DME update, or triple INS mix) being purged ("flushed"). New manual position updates will be accepted.

Position Update Eradication
Figure 210



OPERATIONS MANUAL

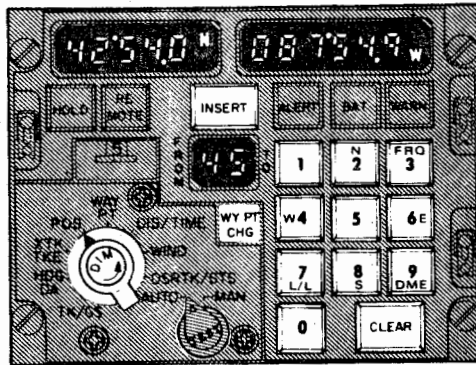

NOTE: If not already accomplished, verify waypoint position data as described in figure 218 prior to making flight plan change insertion.

1. Press WY PT CHG key.
(WY PT CHG and INSERT keys light.)
2. Select new FROM and TO waypoints by pressing corresponding keyboard keys in sequence.
(New waypoint numbers appear in FROM-TO display as keys are pressed.)

NOTE: Selecting zero as the FROM waypoint will cause the desired track to be defined by the computed present position (inertial position plus fixes) and the TO waypoint.

3. Press INSERT key.
(WY PT CHG and INSERT keys go out.)

NOTE: Manual flight plan changes result in the storing of computed present position in waypoint zero. Waypoint zero will contain the ramp coordinates if no manual flight plan change has been performed.

Manual Flight Plan Change Insertion
Figure 211



OPERATIONS MANUAL

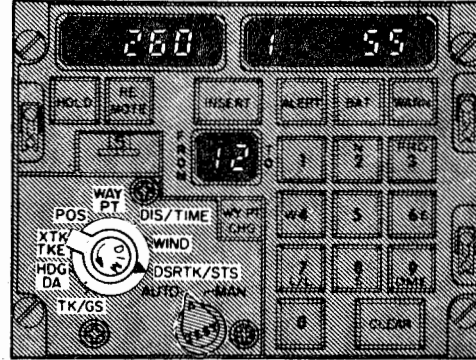
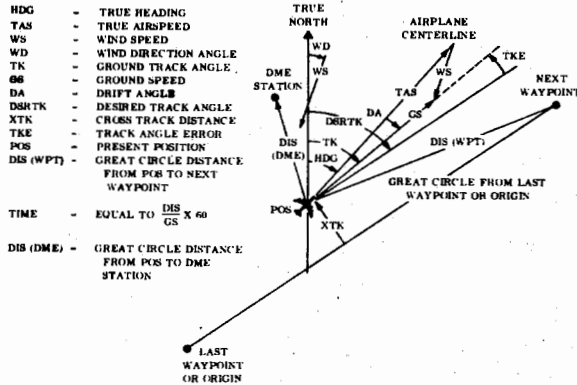

NOTE: The computer is assumed to be in the Nav mode for all displays. For further details on any display, refer to figure 109.

SYSTEM STATUS:

Set data selector to DSRTK/STS.

(Numbers indicating system status appear in right-hand data display.)

PRESENT POSITION:

Set data selector to POS.

(Latitude and longitude of present position appear in left-hand and right-hand data displays, respectively. Both displays are to nearest tenth of a minute.)

INERTIAL PRESENT POSITION:

See figure 208.

TRUE HEADING:

Set data selector to HDG DA.

(Aircraft heading appears in left-hand data display to nearest tenth of a degree.)

GROUND SPEED:

Set data selector to TK/GS.

(Ground speed appears in right-hand data display to nearest knot.)

GROUND TRACK ANGLE:

Set data selector to TK/GS.

(Ground track angle appears in left-hand data display to nearest tenth of a degree.)

DRIFT ANGLE:

Set data selector to HDG DA.

(Drift angle appears in right-hand data display to nearest degree.)



OPERATIONS MANUAL

WIND SPEED AND DIRECTION:

Set data selector to WIND.

(Wind speed to the nearest knot and wind direction to the nearest degree appear in the right-hand and left-hand data displays, respectively.)

DESIRED TRACK ANGLE:

Set data selector to DSRTK/STS.

(Desired track angle appears in right-hand data display to the nearest degree.)

TRACK ANGLE ERROR:

Set data selector to XTK TKE.

(Track angle error appears in right-hand data display to nearest degree.)

CROSS TRACK DISTANCE:

Set data selector to XTK TKE.

(Cross track distance appears in left-hand data display to nearest nautical mile.)

DISTANCE AND TIME TO NEXT WAYPOINT:

Set data selector to DIS/TIME.

(Distance to next waypoint, shown in TO side of FROM-TO display, appears in left-hand data display to nearest nautical mile.

Time to reach next waypoint at present ground speed appears in right-hand data display to nearest tenth of a minute.)

DISTANCE AND TIME TO WAYPOINT OTHER THAN NEXT WAYPOINT:

See figure 213.

DISTANCE AND TIME BETWEEN ANY TWO WAYPOINTS:

See figure 214.

DISTANCE TO ANY DME STATION:

See figure 215.

LATITUDE AND LONGITUDE OF ANY WAYPOINT:

See figure 216.

DME DATA:

See figure 217.



OPERATIONS MANUAL

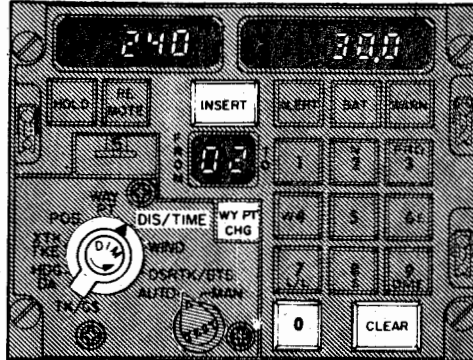

1. Press WY PT CHG key.

(WY PT CHG and INSERT keys light.)

2. Press keyboard key 0.

(FROM side of FROM-TO display changes to 0.)

3. Press keyboard key corresponding to desired waypoint.

(TO side of FROM-TO display changes to desired waypoint number.)

NOTE: Do not press INSERT key. This would cause an immediate flight plan change.

4. Set data selector to DIS/TIME.

(Distance to desired waypoint appears in left-hand data display to nearest nautical mile. Time to reach desired waypoint at present ground speed appears in right-hand data display to nearest tenth of a minute.)

5. To return INS to normal operation, press CLEAR key.

(INSERT and WY PT CHG keys go out. Waypoints defining current navigation leg appear in FROM-TO display.)

Distance And Time To Waypoint Other Than Next Waypoint
Figure 213



Delco Electronics

GENERAL MOTORS CORPORATION MILWAUKEE WISCONSIN 53201

OPERATIONS MANUAL

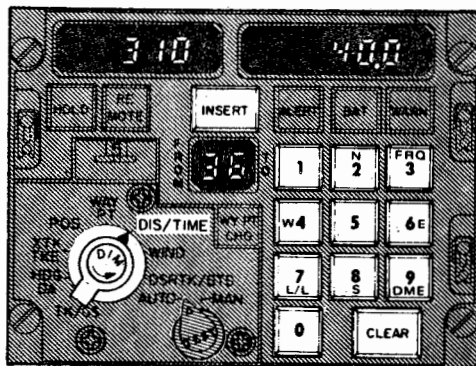

1. Press WY PT CHG key.
(WY PT CHG and INSERT keys light.)
2. Press keyboard keys corresponding to desired waypoints in sequence.
(Desired waypoint numbers appear in FROM-TO display as keys are pressed.)
NOTE: Do not press INSERT key. This would cause an immediate flight plan change.
3. Set data selector to DIS/TIME.
(Distance between desired waypoints appears in left-hand data display to nearest nautical mile. Time to travel between desired waypoints at present ground speed appears in right-hand display to nearest tenth of a minute.)
4. To return INS to normal operation, press CLEAR key.
(WY PT CHG and INSERT keys go out. Waypoints defining current navigation leg appear in FROM-TO display.)

Distance And Time Between Any Two Waypoints
Figure 214



OPERATIONS MANUAL

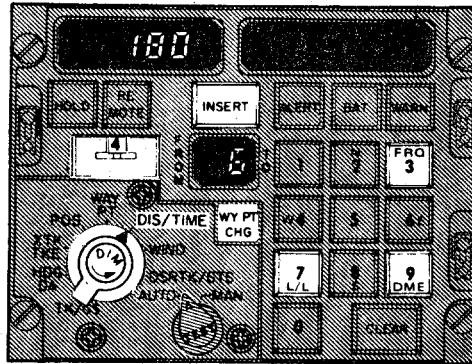

1. Set waypoint/DME selector to desired DME station number.
2. Set data selector to DIS/TIME.
3. Press keyboard keys 7 and 9 or 3 and 9 simultaneously.

(Distance to desired DME station appears in left-hand data display to nearest nautical mile. Right-hand data display is blanked.)

4. To return INS to normal operation, momentarily set data selector to any position other than WAY PT and DIS/TIME.

**Distance To Any DME Station
Figure 215**



OPERATIONS MANUAL

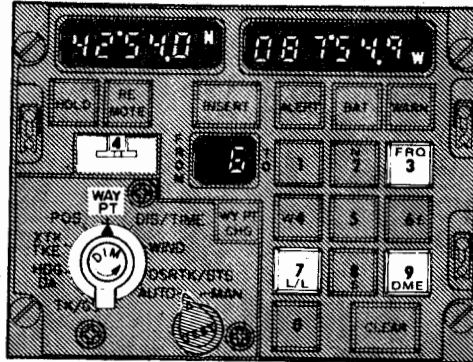

1. Rotate waypoint/ DME selector one position higher than waypoint to be checked and then back to desired position.
2. Set data selector to WAY PT.
3. Press keyboard keys 7 and 9 simultaneously.

(Latitude and longitude of desired DME station to the nearest tenth of a minute appear in left-hand and right-hand data displays, respectively.)

4. Press keyboard keys 3 and 9 simultaneously.

(Altitude of DME station in thousands of feet appears in left-hand data display. Frequency of DME station appears in right-hand data display. Examples: - - - - 8 in left-hand data display = 8,000 feet. 11°05.0 in right-hand data display = 110.50 MHz.)

5. To return INS to normal operation, momentarily set data selector to any position other than WAY PT and DIS/TIME.

DME Data
Figure 217



OPERATIONS MANUAL

NOTE: It is important that waypoint data has been correctly loaded and accepted by the INS to prevent steering to the wrong position. It is also important that DME station data has been correctly loaded to prevent an erroneous DME update.

NOTE: The verification procedure shown below must be done for each individual INS except that in a multiple INS installation using the REMOTE function for loading flight plan data, only the receiving systems must be verified. It is not necessary to verify the transmitting INS if the receiving systems verify correctly.

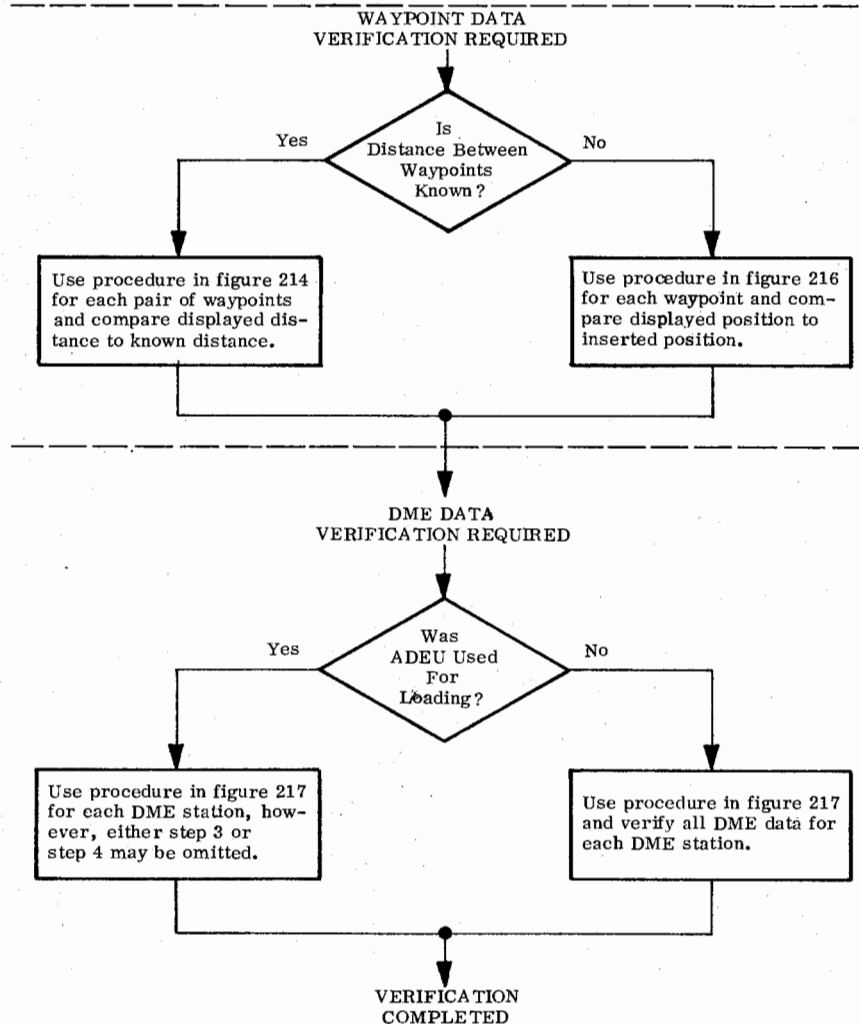

Verification of Flight Plan Data
Figure 218



OPERATIONS MANUAL

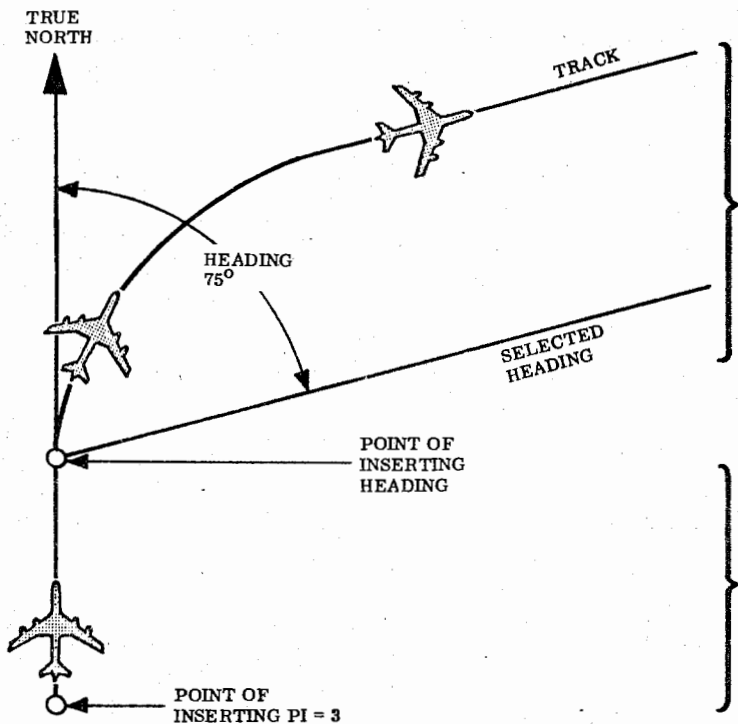

During Heading Select sub-mode, the aircraft will turn and fly on a true heading selected by the pilot. The lateral displacement of the track from the heading at time of insertion is determined by roll rate commanded, aircraft speed, and autopilot.

During Heading Hold sub-mode, the aircraft will fly the heading that it was on at the time of inserting PI = 3 (enabling mode.)

HHS MODE ENABLED/HEADING HOLD

CAUTION: LIMITED TO ONLY CIV-A-HHS-20 PROGRAM.

1. Insure that INS is in the NAV mode.

2. Set data selector to DSRTK/STS.

(If 1---x3 is displayed in right-hand data display, system is already in HHS mode. Proceed directly to step 5.)

3. Press keyboard key 3. Insure that 00003 appears in right-hand data display and that INSERT key is lit before proceeding to next step.

4. Press INSERT key.

(INSERT key goes out. Right-hand data display shows 1---x3. Left-hand data display is --xxx° where xxx is aircraft heading at time of insertion. FROM-TO display is 33.)

NOTE: INS is now in Heading Hold mode and will continue to fly the aircraft heading that the aircraft was on at the time of insertion.

Heading Hold/Select Mode (Sheet 1 of 2)
(Limited to CIV-A-HHS-20 Program)

Figure 219



Delco Electronics

GENERAL MOTORS CORPORATION MILWAUKEE, WISCONSIN 53201

OPERATIONS MANUAL

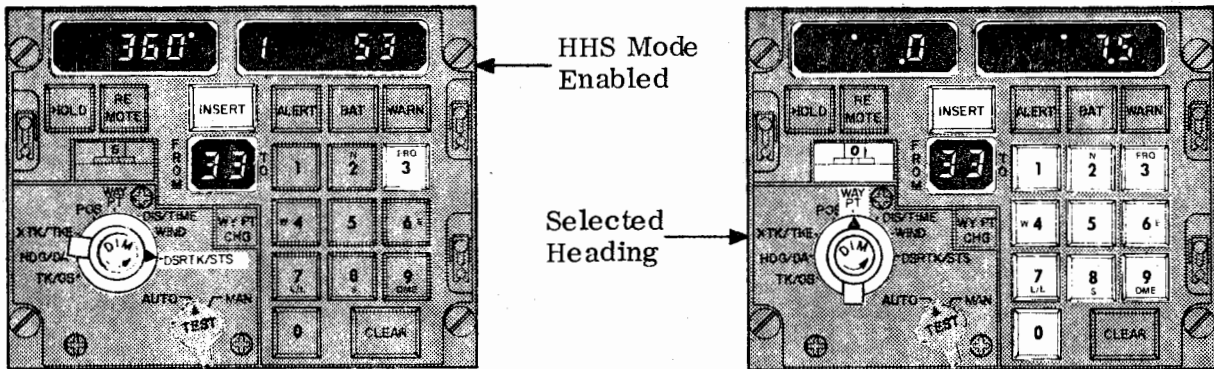

HEADING SELECTED/(INSERTING DESIRED HEADING)

5. Set data selector to WAY PT.

6. Set waypoint/DME selector to waypoint zero (0).

(Left-hand data display is --^o--.0-. Right-hand data display is ---^oxx.x-, where xxx is the aircraft heading from true north at the time the mode was enabled. Heading is from 0 to 360^o. Disregard decimal point.)

7. Load desired heading into C/DU right-hand data display by pressing keyboard keys in sequence, starting with E or W. Example 75^o desired heading = W 7 5.

(INSERT key lights when first key is pressed.)

8. Insure that the desired heading is showing in the right-hand data display (---^oxx.x-), and then press INSERT.

(INSERT key goes out, desired heading is displayed, and the aircraft will turn and fly on the desired heading if under INS control.)

EXITING HEADING HOLD/SELECT MODE

NOTE: Either of the following procedures can be used to exit the HHS mode.

9. Option A — Select and insert a new waypoint pair (example 0 4) as described in figure 211.

Option B — Insert any PI number other than 3 using the procedure in steps 2, 3, and 4 above.

Heading Hold/Select Mode (Sheet 2 of 2)
(Limited to CIV-A-HHS-20 Program)

Figure 219

OPERATIONS MANUAL

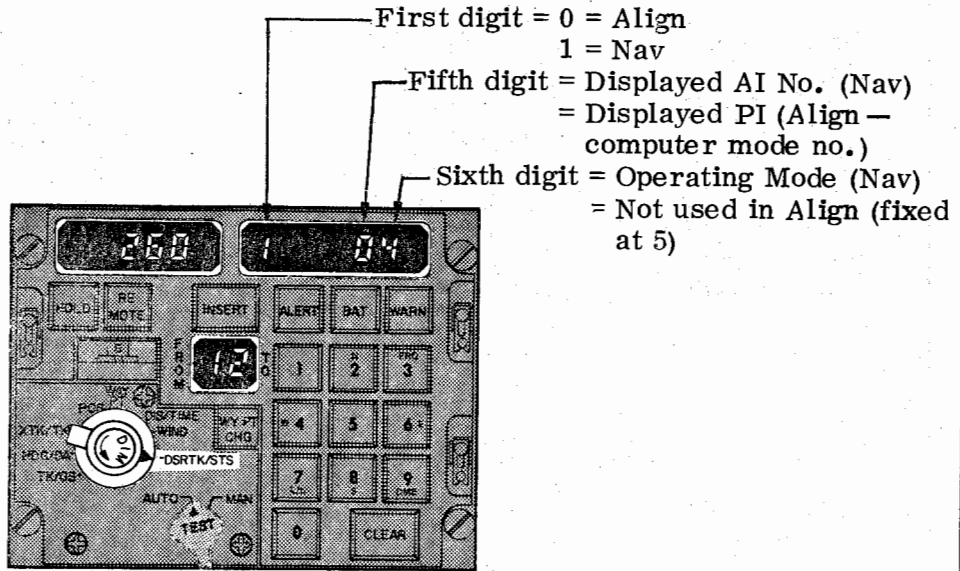

NOTE: This procedure is done only during Nav mode.

NOTE: The displayed AI number will always reflect inertial operation (AI = 3T, where T = Time in Nav in hours) unless DME updating is being accomplished.

1. Set data selector to DSRTK/STS.
2. Observe displayed AI number (fifth digit position of right data display). (AI No. is used in CIV-A-21 and CIV-A-22 programs only)

<p>0 = best performance</p> <p>1</p> <p>2 *</p> <p>⋮</p> <p>9 = inertial performance</p>	<p>↑</p> <p>↓</p>	}	<p>The AI number is roughly approximated to radial error in nmi (worst case estimate). The AI number is limited to "9" which is reached after a 3-hour flight without updating.</p>
--	-------------------	---	---

3. Observe INS operating mode (sixth position of right data display).
 - 4 = DME updating or triple INS mixing commanded.
 - 0, 2, 3, or 5 = Inertial operation (with retained updates unless update eradication has been performed — see figure 210)

*The displayed AI number decreases toward 0 with DME updating but will not go below 2 if altitude information is invalid.

Interpretation of STS Display
Figure 220



OPERATIONS MANUAL

DISCUSSION OF PREFLIGHT PROCEDURES(See figure 201.)

ALTERNATE TURN-ON PROCEDURE

Assuming the NU starts at room temperature (approximately 70°F), the INS will require approximately 15 minutes to go from Off to Nav. The sequence can be made fully automatic by setting the mode selector directly from OFF to NAV and inserting present position immediately.

If this is done, the INS will advance through computer modes 9, 8, 7, and 6 and then, when it reaches 5, will immediately enter Nav. The READY NAV lamp will light momentarily, and the first digit in the right hand data display (data selector set to DSRTK/STS) will change from 0 to 1. The major differences resulting from setting the mode selector immediately to NAV rather than to ALIGN are:

1. An overtemperature will not cause the INS to shut down, but will only light the WARN lamp.
2. Because the INS automatically enters Nav as soon as computer mode 5 is reached, the additional refinements of self-calibration data associated with modes 4 through 0 will not be done. Also, operating in the Nav mode prior to takeoff will effectively lengthen the flight time and allow more time for position errors to build up.
3. The 12-second battery unit check ordinarily done at entry to mode 8 is bypassed when the mode selected is switched directly to NAV from OFF.

AIRPLANE SYSTEM INDICATIONS

The attitude sphere display in the attitude indicators becomes level during computer mode 8 and remains level in all modes until the INS is shut down. Warning indicators for INS attitude indicate that the attitude signals from the INS are valid while the attitude sphere display is level.

The INS can provide test signals to the horizontal situation indicator (HSI), connected digital displays, and INS DME mixing in progress lamps. Pressing the TEST switch during Standby, Align, or Nav mode causes all digits on connected digital displays to indicate 8's, lights the HSI ALERT lamp, and lights the INS DME mixing in progress lamp. Additional HSI test signals are provided when the INS is in Align and the data selector is at any position other than DSRTK/STS. Under those conditions, pressing the TEST switch causes the HSI to indicate heading, drift angle, track angle, and track angle error all at 0°. At the same time, cross track deviation is indicated at 3.75 nautical miles (one dot) right and INS controlled HSI flags are retracted from view. Output test signals are also supplied to autopilots in airplanes where INS steering is commanded. Rotating the AUTO/MAN switch to AUTO and pressing TEST during ALIGN furnishes a 15° left bank steering command. A 15° right bank steering command is furnished when the AUTO/MAN switch is at MAN.



OPERATIONS MANUAL

DISCUSSION OF PRESENT POSITION INSERTION(See figure 202.)

The INSERT key lights when the mode selector is first set to ALIGN, and it does not go out until both latitude and longitude of the present position have been inserted. Until present position has been inserted, the INS can not enter computer mode 6. Also, until mode 7 is entered, the present position can be inserted and corrected as often as necessary. Once mode 7 is entered, however, if present position has been entered, it can not be changed without returning to Standby. If present position has not been entered prior to entering mode 7, it can then be inserted only once. To change it, the INS would have to be returned to Standby.

DISCUSSION OF MANUAL INSERTION OF WAYPOINT COORDINATES (See figure 203.)

When the INS is turned on, all waypoint coordinates are automatically set to 0. Coordinates of any waypoint, including those defining the navigation leg the aircraft is presently flying, can be changed at any time in any mode except Att.

DISCUSSION OF MANUAL INSERTION OF DME STATION DATA(See figure 204.)

DME station 0 can not be used. The data displays for DME station 0 will always duplicate the displays for DME station 1.

The data for any DME station can be changed in any mode except Att. However, if the station being changed is the one being used (appearing in the TO side of the FROM-TO display), the computer will stop using that station when the changed data is inserted. This will be indicated by the TO display changing to 0. This will happen whether the INS is operating in the aided inertial mode or not.

An altitude or frequency which is outside the acceptable limits will not be accepted by the computer. The digits will appear as the keyboard keys are pressed, but when the INSERT key is pressed, the previous value will reappear.

Frequencies are automatically rounded off to end in 0 or 5. Any entry ending in 9, 0, 1, 2, or 3 will be rounded off to 0. Any entry ending in 4, 5, 6, 7, or 8 will be rounded off to 5. For example, both 109.99 and 110.01 MHz would become, when the INSERT key was pressed, 110.00 MHz. Similarly, 110.04 and 110.08 MHz would become 110.05 MHz.

DISCUSSION OF DATA INSERTION USING ADEU (See figure 205.)

Data for all DME stations, whether they are being used or not, can be inserted using the ADEU. If one of the stations is being used (appearing in the TO side of the FROM-TO display), the computer will stop using that station. This will be indicated by the TO display changing to 0. This will happen whether the INS is operating in the aided inertial mode or not. Navaid data will be loaded as DME station 1 if the data is contained in columns 20-22 on the card, as DME station 2 for data in columns 23-25....DME station 9 for columns 44-46, regardless of which DME station, if any, is being used.



OPERATIONS MANUAL

Coordinates of neither the waypoints defining the navigation leg currently being flown nor the intervening waypoints (if any) can be changed. For example, if the navigation leg from waypoint 3 to waypoint 6 is being flown, coordinates of waypoints 3, 4, 5, and 6 can not be changed. Insertion of new waypoints always starts with the first waypoint above the number in the TO side of the FROM-TO display and proceeds consecutively. In the above example, the first 5 waypoints on the nav aid card would be inserted in waypoints 7, 8, 9, 1, and 2, respectively. Any further waypoints on the card would not be loaded. Therefore, care must be taken while loading waypoint data that the data is loaded while the airplane is flying the appropriate leg. Example: If it is desired to load the first waypoint of seven waypoints on the card as waypoint 5, the displayed leg in the FROM-TO display must be 34.

NOTE: An exception is made if waypoint 0 is in the FROM side of the FROM-TO display. Then only the two displayed waypoints are not loaded — for example, when the FROM-TO display is 06, waypoints 7, 8, 9, 1, 2, 3, 4, and 5 would be loaded.

DISCUSSION OF PRESENT INERTIAL POSITION(See figure 208.)

The present inertial position is the position determined solely by the INS inertial instruments. Corrections derived from manual position updates, DME stations, and three-system mixing are not included.

DISCUSSION OF PRESENT POSITION UPDATE(See figure 209.)

If the coordinates of the position reference disagree too greatly with the present inertial position coordinates, the computer will reject the new coordinates, light the WARN lamp, and leave the HOLD key lit. Pressing the hold key will then force the computer to accept the new coordinates. If the disagreement is more than a few degrees, the computer will accept only part of the corrections. Note that the comparison is based on inertial position rather than corrected present position.

DISCUSSION OF POSITION UPDATE ERADICATION(See figure 210.)

This procedure removes all position correction data, including DME-derived data and the results of triple INS mixing. Until new corrections are made, the INS operates solely on uncorrected inertial position. Although PI = 1 is keyed in, the sixth digit will shown "5" after insertion, signifying normal inertial operation.

DISCUSSION OF MANUAL FLIGHT PLAN CHANGE INSERTION (See figure 211.)

The flight plan can be changed at any time, either at a waypoint or between waypoints. If the change is made between waypoints, 0 will normally be loaded in the FROM side of the FROM-TO display. When this is done, the present position coordinates that exist when the INSERT key is pressed will be entered into waypoint 0 and can be read out at any time. The new desired track will be a great circle path directly from the new waypoint 0 to the waypoint shown in the TO display.

If a waypoint other than 0 is loaded in the FROM display, the new desired track will be a great circle path between the FROM and TO waypoints, regardless of where the aircraft is presently located. All cross track error outputs and track angle error outputs will be based on this path.



OPERATIONS MANUAL

REMOTE OPERATIONS

Waypoint coordinates, DME data, and manual position updates can be entered into each INS separately or into two or three simultaneously. To allow simultaneous data entry, press the REMOTE key on each INS into which you wish to enter the data. Data inserted through the keyboard of any one C/DU will then be automatically inserted into all INS in which the REMOTE key has been pressed and lit.

DISCUSSION OF DME STATION SELECTION

To insure favorable geometry during the update process, the following selection criteria should be observed.

1. If single DME only is used, the selected station should be at least 15 nmi off the desired track.
2. If dual DME is used, one of the stations should be at least 15 nmi off the desired track.

DISCUSSION OF AIDED INERTIAL OPERATION

DISCUSSION OF DME UPDATING

Commanding a PI = 4 for any one INS will cause that INS to do updating of its present position if DME data is available. The DME data can come from either the DME receiver connected to the aided inertial commanded INS or it can come from any other INS which is receiving and processing valid DME data from a DME receiver connected to that INS.

DISCUSSION OF TRIPLE INS MIXING

In a three system installation, present position updating can be accomplished using the triple INS mixing process. In each system commanded to do aided inertial operation (PI = 4), and DME updating is not being done, the displayed present position information is updated. In triple INS mixing, the position update reflects approximately that latitude which is between the furthest north and south latitudes and that longitude which is between the furthest east and west longitude.

It is not necessary to have each one of the three systems commanded to do aided inertial operation (PI = 4) to obtain triple INS mixing. Each INS does its own position updating independent of the other two systems; however, all three systems must be operating in the NAV mode with no binary data warn.

The transition from normal operation to triple INS mixing is "eased-on" to eliminate abrupt change in displayed present position and steering information. The updating bias resulting from triple INS mixing is retained after dropping out of triple INS mix (PI \neq 4) unless the bias is flushed by keying in and inserting PI = 1 (position update eradication, figure 210).



Delco Electronics

GENERAL MOTORS CORPORATION MILWAUKEE, WISCONSIN 53201

OPERATIONS MANUAL

DISCUSSION OF "DESIRED PI" NUMBER

The desired PI number (the sixth digit in the C/DU right-hand data display when the C/DU data selector switch is at DSRTK/STS) was originally used by the pilot for the insertion of a desired performance index (PI) number into the INS during align, and was not used at all during NAV. This is no longer true for all current flight programs. The desired PI number is now set to "5" during ALIGN and cannot be changed until the INS enters the Nav mode.

During NAV, the desired PI number can be changed by the pilot (by just pressing a numbered key and then pressing INSERT) and is indicative of the pilot selected operating mode. For example, a PI = 4 indicates that the INS is operating in the aided inertial mode using DME data or triple INS mixing, and PI = 0, 2, or 5 indicates that the INS is operating independently but with any previous fix being retained. PI = 1 can be keyed in and inserted to perform the position update eradication as shown in figure 210, but then the display returns to normal showing a desired PI = 5. (In program CIV-A-19 and earlier inserting a PI = 1 results in the display of a 1 after insertion.)

Desired PI = 3 has the same meaning as PI = 5 for all programs except CIV-HHS-20 where inserting a desired PI = 3 will result in the selection of the Heading/Hold Select mode as shown in figure 220.

Numbers greater than 5 (i.e., 6, 7, 8, or 9) can be keyed into the C/DU display by the pilot, but when INSERT is pressed, the program will interpret and process the number as if were 5. The desired PI would therefore be displayed as a 5 after INSERT had been pressed.



Delco Electronics

GENERAL MOTORS CORPORATION MILWAUKEE, WISCONSIN 53201

OPERATIONS MANUAL

DISCUSSION OF INDICATION OF NAVIGATION PERFORMANCE

NOTE: Applicable to CIV-A-21 and CIV-A-22 programs.

The displayed PI number during NAV (the second digit from the right in the C/DU right-hand data display when the C/DU data selector is at DSRTK/STS) has been made representative of predicted navigation performance. During NAV, this digit, sometimes referred to as the Accuracy Index (AI) number, will range from 0 to 9, with 0 being the best accuracy. The computer forces this number to 0 when the NAV mode is entered. The number progresses toward 9 as time in NAV increases. As DME updating is being performed, the AI number decreases toward 0 but will not go below 2 if altitude information is invalid. The rate of increase or decrease of this number is dependent on time in NAV, DME station geometry, length of time of DME acquisition, and whether dual or single DME updating.

The AI number can be roughly approximated to a worst case estimate of radial error in nmi. The AI number is limited to "9" which is reached after a three hour flight with no DME updating. THE INS PERFORMANCE MAY BE BETTER THAN THAT INDICATED BY THE AI NUMBER. It is intended to provide a measure of the 3σ, or worst case estimate, of navigation performance considering the effects of flight duration and DME updating.



Delco Electronics

GENERAL MOTORS CORPORATION MILWAUKEE, WISCONSIN 53201

OPERATIONS MANUAL

AFTER LANDING PROCEDURES

The INS may be shut down, downmoded to Standby or Align, or left in Nav after landing. The course of action must be determined by the expected length of time before the next takeoff and the anticipated length of the next flight.

CAUTION: DO NOT LEAVE INS OPERATING WHENEVER PRIMARY POWER IS SHUT DOWN, MAY POSSIBLY BE SHUT DOWN, OR DEPENDABILITY IS DOUBTFUL. SET MSU MODE SELECTOR TO OFF.

- 1) LOSS OF INTERRUPTION OF PRIME POWER CAUSES THE INS TO AUTOMATICALLY SWITCH TO DC BACKUP POWER. THIS CAUSES UNNECESSARY DEPLETION OF THE BATTERY.
- 2) LOSS OF PRIME POWER USUALLY INVOLVES CONCURRENT LOSS OF INS COOLING AIR. LOSS OF COOLING AIR CAN CAUSE INS DAMAGE AND/OR RELIABILITY DEGRADATION.

REMAINING IN NAV

If time or aircraft motion does not permit a realignment procedure, a present position update can be performed quickly and easily. Refer to the procedure in figure 209.

DOWNMODING TO ALIGN (REALIGNMENT DURING TRANSIENT STOPS)

A realignment to mode 5 (Nav Ready) can be accomplished in approximately 10 minutes. During the realignment, calibration of the azimuth gyro is updated on the basis of difference between the inserted present position and the last inertial present position prior to downmoding. To accomplish realignment, set the mode selector to STBY and then perform all applicable steps in figure 201.

NOTE: This realignment and recalibration is not necessary for an INS that has been performing accurately (inertial present position close to actual present position), or for an INS that has had a position update made after landing.

DOWNMODING TO STANDBY

Downmoding to Standby will maintain the NU at operating temperature and the gyro wheels at operating speed. To downmode the INS to Standby, set the mode selector to STBY.

SHUTDOWN

To shut the INS down, set the mode selector to OFF.

NOTE: The INS will retain the inertial present position data computed at the time the INS is downmoded. This value will be compared with the present position inserted during the next alignment, and the difference will be used in updating the azimuth gyro calibration. Malfunction 41 will be set if this difference is greater than 76 nmi.



Delco Electronics

GENERAL MOTORS CORPORATION, MILWAUKEE, WISCONSIN 53001

OPERATIONS MANUAL

SECTION 3

ABNORMAL PROCEDURES

PREFLIGHT

Procedures to follow in the event of a malfunction prior to takeoff are given in figure 301. If the malfunction can not be cleared by these procedures, maintenance is required. Record all malfunctions whether or not they are cleared.

IN-FLIGHT

Procedures to follow in the event of a malfunction during a flight are given in figure 302. Record all malfunctions, whether or not they are cleared.

ACTION CODES

Action codes are defined in figure 303.

MALFUNCTION CODES

All malfunction codes are defined in figure 304.

CLEARING C/DU LOCKUP

Procedure to follow in case it is not possible to load displays from C/DU keyboard when WARN lamp is off is given below.

A temporary failure of a numerical key may prevent data loading. If a number cannot be loaded into the latitude or longitude displays after several press/wiggle operations of the key, the problem may be due to a momentary hang-up of another key. To identify this faulty key, rotate the data selector to DSRTK/STS. The right-most digit on the right-hand display will indicate the suspect key. Press and release this suspect key several times. To test whether the keyboard problem is corrected try pressing any other numerical key, this number should now appear as the right-most digit. If this test is successful press the CLEAR key and return the data selector to the original data loading position. Otherwise, a C/DU failure is indicated. If no flags appear, data to HSI and ADI are valid.



OPERATIONS MANUAL

WARN Lamp	Mode	Indications	Probable Cause	Recommended Action
ON	NAV, ALIGN, or STBY	C/DU displays normal.	Nature of failure can be determined by reading out malfunction codes.	<ol style="list-style-type: none"> 1. Set data selector to DSRTK/STS. If action code appears, perform all steps in figure 303. If action code digits are blank, proceed to step 2, below. 2. Set mode selector to ATT. 3. If WARN lamp goes out, INS can be operated in ATT mode and aircraft systems and instruments can use INS attitude outputs but not INS navigation outputs. If WARN lamp remains lighted, set mode selector to OFF.
		C/DU displays lighted but displaying abnormal values.	Computer failure.	<ol style="list-style-type: none"> 1. Set mode selector to ATT. 2. If WARN lamp goes out, INS can be operated in ATT mode and aircraft systems and instruments can use INS attitude outputs but not INS navigation outputs. If WARN lamp remains lighted, set mode selector to OFF.
		C/DU displays go blank and BAT lamp on MSU lights at some time other than the first 12 seconds of mode 8.	Loss of INS power and low INS battery voltage.	<ol style="list-style-type: none"> 1. Set mode selector to OFF. 2. Insure that all circuit breakers required for INS operation are closed. 3. If power is restored, INS can be realigned and INS battery test bypassed by setting mode selector directly from OFF to NAV.
		C/DU displays blank and BAT lamp on MSU not lighted.	Electronics failure	<ol style="list-style-type: none"> 1. Insure that DIM control is clockwise. 2. Set mode selector to ATT. 3. If WARN lamp goes out, INS can be operated in ATT mode and aircraft systems and instruments can use INS attitude outputs but not INS navigation outputs. If WARN lamp remains lighted, set mode selector to OFF.
	ALIGN	C/DU displays go blank and BAT lamp on MSU lights when mode 8 is entered.	Low INS battery voltage.	<ol style="list-style-type: none"> 1. Set mode selector to OFF. 2. INS battery test can be bypassed by setting mode selector directly from OFF to NAV.
	ATT	BAT lamp on MSU lighted.	Loss of INS power and low INS battery voltage.	<ol style="list-style-type: none"> 1. Set mode selector to OFF. 2. Insure that all circuit breakers required for INS operation are closed. 3. If power is restored, INS can be returned to ATT mode and aircraft systems and instruments can use INS attitude outputs but not INS navigation outputs.
BAT lamp on MSU not lighted.		Overtemperature or electronics failure.	Set mode selector to OFF.	
OFF	NAV	C/DU displays are blank, incorrect, or frozen, or can not be loaded from keyboard. No flags appear.	C/DU failure.	Perform Clearing C/DU Lockup procedure. Verify INS outputs on HSI and ADI. If no discrepancies are noted, mode selector can be left in NAV. Aircraft systems and instruments can use INS attitude outputs but not INS navigation outputs.
		HSI and/or true heading flag appears. C/DU displays normal.	A/D or D/A converter failure or loss of 26 volt excitation.	<ol style="list-style-type: none"> 1. Insure that 26 volt synchro excitation circuit breakers are closed. 2. Set data selector to DSRTK/STS and verify that action code 03 appears. 3. Press and release TEST switch and record malfunction code which appears. 4. Repeat step 3 until action code reappears or digits go blank. 5. If action code reappears, mode selector can be left in NAV and C/DU displays can be used, but all INS outputs must be decoupled. If action code does not reappear and flag(s) have disappeared, normal NAV mode operation can be resumed and all INS outputs can be used by aircraft systems and instruments.
	STBY or ALIGN	C/DU displays are blank, incorrect, or frozen, or can not be loaded from keyboard. No flags appear.	C/DU failure.	<ol style="list-style-type: none"> 1. Perform Clearing C/DU Lockup procedure. 2. Set mode selector to ATT. Aircraft systems and instruments can use INS attitude outputs but not INS navigation outputs.
	ALIGN, NAV, or ATT	Primary and auxiliary attitude flags appear any time after entry into mode 8.	Pitch or roll synchro failure or loss of 26 volt synchro excitation.	<ol style="list-style-type: none"> 1. Insure that 26 volt synchro excitation circuit breakers are closed. 2. If flags remain in view and if INS was in Nav mode when flags appeared, INS can be left in NAV and C/DU displays used, but all INS outputs must be decoupled. 3. If flags disappear, normal NAV, ALIGN, or ATT mode operation can be resumed.

Preflight Malfunction Indications and Procedures
Figure 301



OPERATIONS MANUAL

WARN Lamp	Mode	Indications	Probable Cause	Recommended Action
ON	NAV	C/DU displays normal.	Nature of failure can be determined by reading out malfunction codes.	<ol style="list-style-type: none"> 1. Insure that all aircraft systems and instruments using INS outputs are decoupled. 2. Set data selector to DSRTK/STS. If action code appears, perform all steps in figure 303. If action code digits are blank, proceed to step 3, below. 3. Set mode selector to ATT. 4. If WARN lamp goes out, INS can be operated in ATT mode and aircraft systems and instruments can use INS attitude outputs but not INS navigation outputs. If WARN lamp remains lighted, set mode selector to OFF.
		C/DU displays lighted but displaying abnormal values.	Computer failure.	<ol style="list-style-type: none"> 1. Insure that all aircraft systems and instruments using INS outputs are decoupled. 2. Set mode selector to ATT. 3. If WARN lamp goes out, INS can be operated in ATT mode and aircraft systems and instruments can use INS attitude outputs but not INS navigation outputs. If WARN lamp remains lighted, set mode selector to OFF.
		C/DU displays blank and BAT lamp on MSU lighted.	Loss of INS power and low INS battery voltage.	<ol style="list-style-type: none"> 1. Insure that all aircraft systems and instruments using INS outputs are decoupled. 2. Set mode selector to OFF. 3. Insure that all circuit breakers required for INS operation are closed. 4. If power is restored, INS can be operated in ATT and aircraft systems and instruments can use INS attitude outputs but not INS navigation outputs.
		C/DU displays blank and BAT lamp on MSU not lighted.	Electronics failure.	<ol style="list-style-type: none"> 1. Insure that all aircraft systems and instruments using INS outputs are decoupled. 2. Insure that DIM control is clockwise. 3. Set mode selector to ATT. 4. If WARN lamp goes out, INS can be operated in ATT mode and aircraft systems and instruments can use INS attitude outputs but not INS navigation outputs. If WARN lamp remains lighted, set mode selector to OFF.
	ATT	BAT lamp on MSU lighted.	Loss of INS power and low INS battery voltage.	<ol style="list-style-type: none"> 1. Insure that all aircraft systems and instruments using INS output are decoupled. 2. Set mode selector to OFF. 3. Insure that all circuit breakers required for INS operation are closed. 4. If power is restored, INS can be returned to ATT mode and aircraft systems and instruments can use INS attitude outputs but not INS navigation outputs.
		BAT lamp on MSU not lighted.	Overtemperature or electronics failure.	<ol style="list-style-type: none"> 1. Insure that all aircraft systems and instruments using INS outputs are decoupled. 2. Set mode selector to OFF.
OFF	NAV	C/DU displays are blank, incorrect, or frozen, or can not be loaded from keyboard. No flags appear.	C/DU failure.	Perform Clearing C/DU Lockup procedure. Verify INS outputs on HSI and ADI. If no discrepancies are noted, mode selector can be left in NAV. Aircraft systems and instruments can use INS attitude outputs but not INS navigation outputs.
		HSI and/or true heading flag appears. C/DU displays normal.	A/D or D/A converter failure or loss of 26 volt excitation.	<ol style="list-style-type: none"> 1. Insure that all aircraft systems and instruments using INS outputs are decoupled. 2. Insure that 26 volt synchro excitation circuit breakers are closed. 3. Set data selector to DSRTK/STS and verify that action code 03 appears. 4. Press and release TEST switch and record malfunction code which appears. 5. Repeat step 4 until action code reappears or digits go blank. 6. If action code reappears, mode selector can be left in NAV and C/DU displays can be used, but all INS outputs must remain decoupled. If action code does not reappear and flag has disappeared, normal NAV mode operation can be resumed, with all INS outputs reconnected.
	NAV or ATT	Primary and auxiliary attitude flags appear.	Pitch or roll synchro failure or loss of 26 volt synchro excitation.	<ol style="list-style-type: none"> 1. Insure that all aircraft systems and instruments using INS outputs are decoupled. 2. Insure that 26 volt synchro excitation circuit breakers are closed. 3. If INS is in NAV mode when flags appear, it can be left in NAV and the C/DU displays used but all INS outputs must remain decoupled. 4. If flags disappear, normal NAV or ATT mode operation can be resumed, with all applicable INS outputs reconnected.

In-Flight Malfunction Indications and Procedures
Figure 302



OPERATIONS MANUAL

The diagram shows a control panel with two digital displays. The left display shows '354' and the right display shows '105 55'. A 'DATA SELECTOR' knob is on the left, and a 'TEST SWITCH' is at the bottom. A numeric keypad (0-9) and 'CLEAR' button are on the right. Various indicator lights and buttons are labeled, including 'HOLD', 'RE NOTE', 'INSERT', 'ALERT', 'BAT', 'WARN', 'POS', 'DIS/TIME', 'WY PT CHG', 'TKE', 'HOG DA', 'TK/GS', 'WIND', 'DSRTK/STS', 'AUTO', and 'MAN'.

1. Insure that data selector is set to DSRTK/STS.
(Action code is present in 2nd and 3rd digits of right-hand data display.)
2. Press and release TEST switch.
(Malfunction code replaces action code in data display.)
3. Record malfunction code.
4. Repeat steps 2 and 3 until either 2nd and 3rd digits in right-hand data display go blank and WARN lamp goes out, or action code reappears.
5. If WARN lamp goes out and 2nd and 3rd digits go blank, failure was intermittent and has been cleared. INS can resume operation in mode in which INS was operating when WARN lamp lighted and INS outputs can be used by aircraft systems and instruments.
6. If WARN lamp remains lighted and action code reappears following last action code, comply with action code as follows:

<u>Code</u>	<u>Action</u>
01	Set mode selector to OFF.
02	Watch data displays for degradation. Select ATT mode if necessary.
03	Check instruments and 26 volt circuit breakers. One or more analog outputs are unreliable.
04	Downmode to STBY and restart alignment (ground operation only).
05	Reload nav aid data via ADEU. If unable to load data via ADEU, load data manually via C/DU.

Recommended Action And Malfunction Code Display Procedure
Figure 303



OPERATIONS MANUAL

Malf Code	Failed Test	Modes of Operation	Recommended Action Code
13	Y velocity change	NAV	02
14	X velocity change	NAV	02
15	Y gyro torque limited	ALIGN, NAV	02
18	Excessive saturation time	ALIGN	04
22*	TK or TKE + DA converter	ALIGN, NAV	03
23*	DA converter	ALIGN, NAV	03
24*	TKE or steering converter	ALIGN, NAV	03
25*	HDG or steering converter	ALIGN, NAV	03
26*	XTK converter	ALIGN, NAV	03
27*	Tick mark pulse timing	ALIGN	None
31	Ground Speed	NAV	02
32	Memory parity	STBY, ALIGN, NAV	02
33	Azimuth stabilization loop noise	STBY, ALIGN, NAV	01
34	Inner roll stabilization loop noise	STBY, ALIGN, NAV	01
35	Pitch stabilization loop noise	STBY, ALIGN, NAV	01
36	Accelerometer loop noise	STBY, ALIGN, NAV	01
37	Z platform overtemperature	NAV	01
38	XY platform overtemperature	NAV	01
39	Oven overtemperature	NAV	01
41**	Loaded present position	ALIGN	04
42	Drift angle 45° or greater	NAV	02
43	Intersystem comparison	ALIGN	04
45	Gyro scale factor or loaded latitude	ALIGN	04

*Failed test does not light WARN lamp on C/DU. If ground speed is less than 75 knots, failure must continue for minimum of 6 seconds before this code is set. During flight, momentary power loss due to switchover can set this code.

**This malf is set if the loaded present position is more than 76 nmi from the calculated inertial position stored in the computer when the INS was last shut down. Check that correct present position was loaded. Reload if required. Rotate data selector to DSTRK/STS and clear malfs.



Delco Electronics

GENERAL MOTORS CORPORATION MILWAUKEE WISCONSIN 53201

OPERATIONS MANUAL

Malf. Code	Failed Test	Modes of Operation	Recommended Action Code
49	Position update	NAV	02
55	Data from ADEU fails reasonableness test	STBY, ALIGN, NAV	05
57	XY platform rotation rate	ALIGN	04
59	600 millisecond loop	STBY, ALIGN, NAV	02
60	X or Y sample and hold change	ALIGN	04
61	X or Y sample and hold	ALIGN	04
62	XY platform rotation rate	NAV	02
63	Computer self checks	STBY, ALIGN, NAV	02



Delco Electronics

GENERAL MOTORS CORPORATION MILWAUKEE, WISCONSIN 53201

OPERATIONS MANUAL

C/DU BAT INDICATOR IS LIT

CAUTION: THE INS CAN OPERATE ONLY A LIMITED TIME (NOMINALLY 15 MINUTES WITH THE STANDARD BATTERY) ON BATTERY POWER BEFORE A LOW VOLTAGE SHUTDOWN WILL OCCUR. THEREFORE CORRECTIVE ACTION MUST BE EXPEDITIOUSLY TAKEN.

NOTE: The C/DU BAT indicator will light for 12 seconds in align mode 8 (about 5 minutes after INS turnon). This is normal and indicates a battery test is in process. No corrective action is required.

Determine corrective action by monitoring the C/DU data displays while rotating the C/DU data selector switch.

- If the displays are frozen (do not change while the data selector is being rotated), the problem is probably in the NU computer. The INS can be used as an attitude reference by rotating the MSU mode selector to ATT.
- If the displays respond normally to the data selector switch, the problem is probably the absence of 115 vac power to the INS. Refer to the airplane manual for proper corrective action (such as checking ac circuit breakers, switching alternators, etc.).

The C/DU BAT indicator should go out after the above corrective action. If it remains lit, the INS will eventually shutdown when the battery voltage drops below approximately 19 vdc. The flight crew should prepare for this shutdown.

ABNORMAL WIND DISPLAYS IN FLIGHT

In most cases, abnormal wind displays that occur in flight, assuming that there is no C/DU WARN, are caused by problems in the air data system providing true air speed data to the INS or in the associated aircraft interface wiring. However, under certain conditions, in aircraft equipped with KIFIS air data systems, an abnormal wind display can occur with the wind magnitude and/or direction exhibiting a substantial error which is due to the ambiguity present in the KIFIS TAS synchro output. The errors in the wind display are large enough to be obvious to the flight crew. This error does not occur in normal aircraft operating regions but can occur when the following conditions are present.

- 1) Headwind > 200 knots and actual TAS > 366 knots, or
- 2) Tailwind > 133 knots and actual TAS < 366 knots.

These conditions are rarely encountered on most route structures. Actual encounters should occur only at high altitudes (> 20,000 feet) and for relatively short positions of the flight. The above conditions are not foreseeable in the altitude regions where interest in wind magnitude and direction is greatest.

