

# operator's guide

**Collins**  
**WXR-2100**  
**MultiScan™ Radar**  
**Fully Automatic Weather**  
**Radar**

**operator's guide**

***NOTICE***

**INFORMATION SUBJECT TO EXPORT CONTROL LAWS**

This document may contain technical data that may be restricted for export under the International Traffic in Arms Regulations (ITAR) or the Export Administration Regulations (EAR). Violations of these export laws may be subject to fines and penalties under the Arms Export Control Act (22 U.S.C. 2778).

**Rockwell**  
**Collins**

For product orders or inquiries, please contact:

Rockwell Collins  
Customer Response Center  
400 Collins Rd NE M/S 133-100  
Cedar Rapids, IA 52498-0001

TELEPHONE: 1.888.265.5467  
INTERNATIONAL: 1.319.265.5467  
FAX NO: 1.319.295.4941  
EMAIL: [response@rockwellcollins.com](mailto:response@rockwellcollins.com)

© Copyright 2003 Rockwell Collins, Inc. All rights reserved.

Printed in the USA

#### **SOFTWARE COPYRIGHT NOTICE**

© Copyright 2002 - 2003 Rockwell Collins, Inc. All rights reserved.  
All software resident in the equipment covered by this publication is  
protected by copyright.

## TABLE OF CONTENTS

Tab Title	Page
1 INTRODUCTION	
Safety Summary .....	1-2
List of Acronyms and Abbreviations .....	1-2
2 OVERVIEW	
Introduction .....	2-1
System Description .....	2-1
Key Operating Features .....	2-1
3 THEORY OF OPERATION	
Thunderstorm Reflectivity .....	3-1
The Ideal Radar Beam .....	3-4
MultiScan Emulation of the Ideal Radar Beam .....	3-5
The MultiScan Process .....	3-6
Update Rates .....	3-7
Automatic Gain .....	3-8
The End Result .....	3-8
4 MULTISCAN OPERATION	
MultiScan Control Panels .....	4-1
Airbus Control Panel .....	4-1
Boeing Control Panels .....	4-2
Display Annunciations .....	4-4
Airbus Display Annunciations .....	4-4
Boeing Display Annunciations .....	4-7
Retrofit Aircraft Display Annunciations .....	4-9
Tilt Annunciation (What Does It Mean During Automatic Operation?) .....	4-11
MultiScan Automatic Operation .....	4-12
General Controls .....	4-12
Power (On/Off) .....	4-12
Automatic Operation (On/Off) .....	4-13
Ground Clutter (On/Off) .....	4-16
Tilt Control (Inoperative During Automatic Operation) .....	4-17
Dual System Selection (For Aircraft Equipped with two R/Ts) .....	4-18
TFR (Transfer) – Boeing Only .....	4-20
Weather Detection .....	4-22

Tab Title	Page
Weather Detection Characteristics During Automatic Operation .....	4-22
Modes of Operation .....	4-27
Gain PLUS™ (Available During Automatic Operation) .....	4-35
Windshear .....	4-45
Test .....	4-52
MultiScan Manual Operation .....	4-57
Manual Operation: Control Panel Inputs and Operating Procedures .....	4-57
Manual Operation (MAN/AUTO) .....	4-58
Ground Clutter (Inactive For Manual Operation) .....	4-60
Tilt Control .....	4-61
Over-scan Prevention – Pilot Techniques .....	4-72
Storm Height Estimation (Radar Top Only) .....	4-76
Long Range (Over the Horizon) Weather Detection .....	4-79
Gain .....	4-82
The Total Weather Picture .....	4-82
<b>5 AVIATION WEATHER</b>	
Reflectivity .....	5-1
The Water Molecule and Reflectivity .....	5-1
Bright Band .....	5-4
Thunderstorm Reflectivity .....	5-5
Thunderstorms .....	5-8
Introduction .....	5-8
Single-Cell Thunderstorm Development .....	5-8
Multi-Cell Thunderstorms .....	5-11
Steady-State Thunderstorms .....	5-13
Thunderstorm Characteristics .....	5-14
Squall Lines .....	5-20
Microbursts And Windshear .....	5-22
Microbursts .....	5-22
Windshear .....	5-26
Hazardous Weather .....	5-31
Introduction .....	5-31
Steep Gradient .....	5-33
Scalloped Edges, Pendant, Finger, Hook, U-Shape .....	5-34
Non-Reflective Weather .....	5-37

Tab Title	Page
6 HOW RADAR WORKS	
The Radar System .....	6-1
Frequency Comparison .....	6-2
Gain .....	6-4
Calibrated Gain Color Scheme .....	6-4
Gain Control Settings .....	6-5
Gain Tables .....	6-6
Airbus .....	6-6
Boeing .....	6-7
Effects Of Gain Selection .....	6-8
Antenna Characteristics .....	6-12
Parabolic Versus Flat-Plate Antennas .....	6-12
Antenna Side Lobes and False Windshear Warnings .....	6-14
Antenna Calibration .....	6-16
Antenna Stabilization .....	6-17
Radar Beam Characteristics .....	6-19
Beam Diameter .....	6-20
Range And Azimuth Resolution .....	6-21
Beam Attenuation .....	6-23
Sensitivity Time Control (STC) .....	6-24
Long-Range Color Enhancement .....	6-26
Path Attenuation (Radar Shadow) .....	6-27
Radome Characteristics .....	6-30
Cat's Eyes/Ghost Targets .....	6-30
Radome Inspection .....	6-31
Doppler Turbulence .....	6-32
Windshear .....	6-33
Windshear Event .....	6-33
Automatic Enable .....	6-35
Collins' Windshear Philosophy .....	6-36
Alert Level Activation Regions .....	6-39
Airbus .....	6-40
Boeing .....	6-42
MVD™ Windshear Recording .....	6-43
Alien Radar .....	6-44
Radiation Hazards .....	6-44
GLOSSARY .....	Glossary-1
INDEX .....	Index-1

This page intentionally left blank

## ***LIST OF ILLUSTRATIONS***

Figure	Title	Page
3-1	Thunderstorm Reflectivity Levels .....	3-1
3-2	Observed Thunderstorm .....	3-2
3-3	Observed Thunderstorm and Corresponding Radar Display at Varying Tilt Settings .....	3-3
3-4	Ideal Radar Beam .....	3-4
3-5	MultiScan Emulation of Ideal Beam .....	3-5
3-6	The MultiScan Process .....	3-6
3-7	MultiScan Upper and Lower Scan .....	3-6
3-8	MultiScan Updates Image For Aircraft Movement .....	3-7
3-9	MultiScan Updates Image After Heading Change .....	3-8
3-10	MultiScan Display With GCS Off .....	3-9
3-11	MultiScan Display With GCS On .....	3-10
4-1	Airbus Dual-System, Single-Function Control Panel, #622-5130-820 .....	4-1
4-2	Boeing Single-System, Split-Function Control Panel #622-5129-801 .....	4-2
4-3	Boeing Dual-System, Split-Function Control Panel #622-5130-801 .....	4-3
4-4	Boeing Split-Function Control Areas .....	4-3
4-5	Airbus Automatic and Manual Operation Annunciations .....	4-5
4-6	Airbus Automatic Function Fail Annunciation .....	4-6
4-7	Boeing Automatic and Manual Operation Annunciations .....	4-8
4-8	Retrofit Manual Operation .....	4-9
4-9	Retrofit Automatic Function Fail Annunciation .....	4-10
4-10	Airbus Control Panel .....	4-12
4-11	Airbus MULTISCAN MAN/AUTO Control .....	4-13
4-12	Boeing AUTO Control .....	4-14
4-13	MultiScan Initialization Process .....	4-15
4-14	Airbus GCS Control .....	4-16
4-15	Boeing GC Control .....	4-17
4-16	Airbus TILT Control .....	4-17
4-17	Boeing TILT Control .....	4-18
4-18	Airbus (Single & Dual R/T Configurations) .....	4-19
4-19	Boeing (Dual R/T Configuration Only) .....	4-20
4-20	Boeing Transfer Control .....	4-21
4-21	Optimized Weather at Various Ranges .....	4-23

Figure Title	Page
4-22 MultiScan Low Altitude Operation .....	4-24
4-23 Extended Range Weather Example .....	4-24
4-24 MultiScan Tilt for Long Range Scan .....	4-25
4-25 MultiScan 320 NM Strategic Weather Display .....	4-26
4-26 Airbus WX Control .....	4-27
4-27 Boeing WX Control .....	4-27
4-28 Weather Mode (WX) Typical Display .....	4-28
4-29 Airbus WX+T Control .....	4-29
4-30 Boeing WX+T Control .....	4-29
4-31 Weather Plus Turbulence Mode At 40 NM Range .....	4-30
4-32 Weather Plus Turbulence Mode At 80 NM Range .....	4-31
4-33 Airbus TURB Control .....	4-32
4-34 TURB (Turbulence Only) Mode Display .....	4-32
4-35 Airbus MAP Control .....	4-33
4-36 Boeing MAP Control .....	4-34
4-37 Map Mode Typical Display .....	4-34
4-38 GAIN Set to <b>CAL</b> .....	4-36
4-39 GAIN Set to <b>MAX</b> .....	4-37
4-40 GAIN Set to <b>MIN</b> .....	4-38
4-41 PAC Alert on Weather Display .....	4-40
4-42 Pitfalls of Over-Scanning Thunderstorms .....	4-41
4-43 Wet Top of Thunderstorm in Upper Beam .....	4-42
4-44 Wet Top of Thunderstorm in Lower Beam .....	4-42
4-45 Wet Top of Thunderstorm in Memory .....	4-42
4-46 OverFlight Protection to 22,000 Feet .....	4-43
4-47 Airbus GAIN Control .....	4-44
4-48 Boeing GAIN Control .....	4-44
4-49 Windshear Alert and Displays .....	4-46
4-50 Airbus/Retrofit Windshear Detection Coverage .....	4-47
4-51 Boeing Windshear Detection Coverage .....	4-49
4-52 Airbus PWS Control .....	4-52
4-53 Boeing TEST Control .....	4-53
4-54 Boeing TEST Display .....	4-55
4-55 Airbus MULTISCAN MAN/AUTO Control .....	4-58
4-56 Boeing AUTO Control .....	4-59
4-57 Airbus GCS Control .....	4-60
4-58 Boeing GC Control .....	4-60
4-59 Airbus TILT Control .....	4-61
4-60 Boeing TILT Control .....	4-62
4-61 Tilt Setting Compromise .....	4-62
4-62 Recommended Tilt For Low Altitude .....	4-63



Figure	Title	Page
4-63	Climb Out Flight Path .....	4-64
4-64	Recommended Tilt Settings For Descent .....	4-66
4-65	Effects of Tilt Set Too Low During Descent .....	4-67
4-66	Result of Not Raising Tilt As Altitude Decreases .....	4-67
4-67	Radar Display with Tilt Setting Too Low .....	4-68
4-68	Radar at 80 NM, Mid Altitude .....	4-69
4-69	Radar at 160 NM, Mid Altitude .....	4-70
4-70	Radar Displays Using Split Function .....	4-73
4-71	TILT Set to Zero, GAIN Set to MAX: Minimal Weather Return .....	4-74
4-72	TILT Set to -7°, GAIN Set to MAX: Strong Weather Return .....	4-75
4-73	Using Tilt to Estimate Radar Top of Thunderstorm .....	4-77
4-74	Radar Display of Storm Top .....	4-78
4-75	TILT Set To Scan Radar Horizon .....	4-79
4-76	Long Range Scan With Minimal Down Tilt .....	4-80
4-77	Long Range Scan With Increased Down Tilt .....	4-80
4-78	Weather Return Visible At Edge of Radar Horizon .....	4-81
5-1	Basic Water Molecule .....	5-1
5-2	Reflectivity Characteristics of Precipitation .....	5-3
5-3	Anatomy of Thunderstorm Weather Radar Reflectiv- ity .....	5-5
5-4	Thunderstorm Radar Displays versus Tilt Angle .....	5-7
5-5	Severe Thunderstorm Activity .....	5-8
5-6	Thunderstorm — Towering Cumulus Stage .....	5-9
5-7	Thunderstorm — Mature Stage .....	5-10
5-8	Thunderstorm — Dissipating Stage .....	5-11
5-9	Multi-Cell Thunderstorm .....	5-12
5-10	Steady-State Thunderstorm Structure .....	5-14
5-11	NEXRAD Thunderstorm With Turbulent Outflow .....	5-15
5-12	Thunderstorm Vaulting .....	5-16
5-13	Oceanic Weather Cell .....	5-17
5-14	“Skinny” Oceanic Weather Cell .....	5-18
5-15	“Anvil Top” Oceanic Weather Cell .....	5-19
5-16	Prefontal Squall Lines .....	5-20
5-17	Prefontal Squall Lines Weather Radar Display .....	5-21
5-18	Microburst Formation .....	5-22
5-19	Stationary and Moving Microburst Impact Patterns .....	5-23
5-20	Weather Radar Rainfall Display .....	5-24
5-21	Weather Radar Virga Display .....	5-25
5-22	Windshear Example — Approach Conditions .....	5-26

Figure Title	Page
5-23 Windshear Example — Headwind Zone .....	5-27
5-24 Windshear Example — Power Reduction .....	5-28
5-25 Windshear Example — Indicated Airspeed Transi- tion .....	5-29
5-26 Windshear Event — Recovery or Loss of Flight .....	5-30
5-27 Normal Thunderstorm Shape .....	5-31
5-28 Shear Conditions within Thunderstorm Shape .....	5-32
5-29 Steep-Gradient Thunderstorm .....	5-33
5-30 Thunderstorm Showing Scalloped Edges .....	5-34
5-31 Thunderstorm Showing Pendants .....	5-35
5-32 Thunderstorm Showing Fingers .....	5-35
5-33 Thunderstorm Showing A Hook .....	5-36
5-34 Thunderstorm Showing A U-Shape .....	5-36
5-35 Popcorn-Shaped Cumulous Cloud Buildups .....	5-37
5-36 Popcorn-Shaped Cumulous Cloud Turbulence .....	5-38
6-1 Loop Gain (Signal to Noise Ratio) .....	6-1
6-2 WXR-2100 Weather Radar System Block Diagram .....	6-2
6-3 Low Audio Frequency Propagation Through Weather .....	6-3
6-4 Medium and High Frequency (MF/HF) Propagation Through Weather .....	6-3
6-5 Very High Frequency (VHF) Propagation Through Weather .....	6-3
6-6 Radar Operating Bands .....	6-4
6-7 Calibrated Gain Color Scheme .....	6-5
6-8 Radar Displays with Gain set to <b>MIN</b> and -12 dB .....	6-8
6-9 Radar Displays with Gain set to -8 dB and -6 dB .....	6-9
6-10 Radar Displays with Gain set to -4 dB and -2 dB .....	6-10
6-11 Radar Displays with Gain set to <b>CAL</b> and +4 dB .....	6-11
6-12 Radar Displays with Gain set to +8 dB and <b>MAX</b> .....	6-12
6-13 Parabolic Radar Antenna Beam Patterns .....	6-13
6-14 Flat-Plate Radar Antenna Beam Patterns .....	6-13
6-15 Weather Radar Antenna Side Lobes .....	6-14
6-16 New Radar Antenna Showing Minimal Side Lobes .....	6-15
6-17 Degraded Radar Antenna Showing Extensive Side Lobes .....	6-15
6-18 Stabilized Radar Antenna Orientation versus Aircraft Attitude .....	6-17
6-19 Unstabilized Radar Orientation versus Aircraft Attitude .....	6-18
6-20 Weather Radar Beam “Slice” and Resulting Display .....	6-19

Figure Title	Page
6-21 Weather Radar Beam Width Increases Over Distance .....	6-20
6-22 Range Resolution versus Azimuth Resolution .....	6-22
6-23 Radar Beam Attenuation .....	6-23
6-24 Effects of Radar Beam Attenuation on the Radar Display .....	6-24
6-25 Receiver Sensitivity versus Target Distance .....	6-25
6-26 STC Weather Compensation for Two Identical Cells .....	6-25
6-27 STC Weather Radar Display Compensation .....	6-26
6-28 Long Range Color Enhancement Display .....	6-27
6-29 Weather Display with Radar Shadow .....	6-28
6-30 Radar Displays of Penetration of Thunderstorm .....	6-29
6-31 Cat's Eyes Returns on Radar .....	6-31
6-32 Non-Turbulent versus Turbulent Targets .....	6-33
6-33 NASA Hazard Factor for Windshear .....	6-34
6-34 ILS Rwy 1 Approach, Albany NY .....	6-37
6-35 Windshear Coverage From IAF, ILS Rwy 1 Ap- proach .....	6-38
6-36 Windshear Coverage in Crosswind on Approach .....	6-39
6-37 Airbus Windshear Alert Activation Region for Takeoff .....	6-40
6-38 Airbus Windshear Alert Activation Region for Landing .....	6-41
6-39 Boeing Windshear Alert Activation Region for Takeoff .....	6-42
6-40 Boeing Windshear Alert Activation Region for Landing .....	6-43
6-41 Interference Pattern From Military Radar-Jamming System on Radar Display .....	6-44

This page intentionally left blank

---

**TABLE OF CONTENTS**

---

Title	Page
Introduction .....	1-1
Safety Summary .....	1-2
List of Acronyms and Abbreviations .....	1-2

This page intentionally left blank

## INTRODUCTION

This pilot's guide has been written to work much like your new "plug and play" computer. All the appropriate systems information is here and should be read and understood, but a "quick start" method is also provided for those who like to dive right in.

This guide is divided into five sections: MultiScan Overview, MultiScan Theory of Operations, MultiScan Operations (automatic and manual), Aviation Weather, and How Radar Works. It is strongly recommended that you read, in their entirety, the Aviation Weather and How Radar Works sections first. These sections lay the ground work for understanding why the radar operates in the manner that it does.

However, for those who like to dive right in without reading all the instructions, you can use the "quick start" method and begin with the MultiScan Operations section (automatic and manual). This section will give you the basics on how to operate the radar. When you see the reference "(♦page x-xx)", you will know that there is information that directly supports understanding of the current subject on the page listed.

Occasionally there are aspects of the radar that are specific to either Airbus or Boeing aircraft. When this occurs, you will see either an A320 icon for Airbus or a B737 icon for Boeing and you will know that the particular section is specific to that particular airframe manufacturer.



### NOTE

For those who are not using the MultiScan radar but have access to this pilot's guide, you should still find the sections on manual operation, Aviation Weather, and How Radar Works informative. These sections are applicable to most radar systems.

To submit comments regarding this manual, please contact:

Collins Aviation Services  
Rockwell Collins, Inc.  
400 Collins Rd NE  
Cedar Rapids, IA 52498-0001

Attn: Technical Operations M/S 153-250

or send email to: [techmanuals@rockwellcollins.com](mailto:techmanuals@rockwellcollins.com)

## **SAFETY SUMMARY**

### **WARNING**

Weather Radar must never be used as a primary collision-avoidance or ground proximity warning device. While the Weather Radar can supply some terrain information, it remains fundamentally the pilot's responsibility to be alert to these dangerous situations and use all information at his disposal to maintain maximum safety and comfort for himself, his crew, his passengers, and his aircraft.

### **WARNING**

This guide is for training purposes only. Individual operators may set specific operating procedures which may not be the same as those described in this guide. Refer to the appropriate airplane flight manuals for information specific to your airplane.

## **LIST OF ACRONYMS AND ABBREVIATIONS**

<b>AGL</b>	Above Ground Level
<b>ARINC</b>	Aeronautical Radio, Inc.
<b>AUTO</b>	Automatic
<b>BITE</b>	Built-In Test Equipment
<b>CAL</b>	Calibrated
<b>CFDS</b>	Centralized Fault Display Unit
<b>CMC</b>	Central Maintenance Computer
<b>dB</b>	Decibel (refer to the Glossary for further explanation)
<b>dBZ</b>	Radar Reflectivity Factor expressed in decibels: $dBZ = 10 \log Z$ (refer to "Z" in the Glossary for further explanation)
<b>DN</b>	Down
<b>EFIS</b>	Electronic Flight Instrument System
<b>GC</b>	Ground Clutter
<b>GCS</b>	Ground Clutter Suppression
<b>HF</b>	High Frequency
<b>IAS</b>	Indicated Airspeed
<b>KHz</b>	Kilohertz
<b>L/R</b>	Left/Right Receiver/Transmitter
<b>MAN</b>	Manual
<b>MAT</b>	Maintenance Access Computer
<b>MAX</b>	Maximum



<b>MCDU</b>	Multifunctional Control Display Unit
<b>MF</b>	Medium Frequency
<b>MHz</b>	Megahertz
<b>MIN</b>	Minimum
<b>m/s</b>	Meters per Second
<b>MSL</b>	Mean Sea Level
<b>MVD™</b>	Magnitude Velocity Deviation
<b>mW/cm<sup>2</sup></b>	Milliwatts per square Centimeter
<b>NASA</b>	National Aeronautics and Space Administration
<b>NM</b>	Nautical mile(s)
<b>OEM</b>	Original Equipment Manufacturer
<b>PAC</b>	Path Attenuation Compensation
<b>PWS</b>	Predictive Windshear
<b>RDR</b>	Radar
<b>R/T</b>	Receiver/Transmitter
<b>STBY</b>	Standby
<b>STC</b>	Sensitivity Time Control
<b>SW</b>	Switched
<b>SYS</b>	System
<b>TFR</b>	Transfer
<b>TURB</b>	Turbulence
<b>VAR</b>	Variable
<b>VHF</b>	Very High Frequency
<b>WX</b>	Weather
<b>WX+T</b>	Weather Plus Turbulence
<b>WXR</b>	Weather Radar System
<b>Z</b>	Radar Reflectivity Factor (refer to the Glossary for further explanation)

This page intentionally left blank

---

## **TABLE OF CONTENTS**

---

Title	Page
Introduction .....	2-1
System Description .....	2-1
Key Operating Features .....	2-1

This page intentionally left blank

# OVERVIEW

---

## INTRODUCTION

The Rockwell Collins WXR-2100 MultiScan Radar is a revolutionary approach to the way weather information is processed and refined. MultiScan is a fully automatic radar that displays all significant weather at all ranges, at all aircraft altitudes, and at all times without the need for pilots to input tilt or gain settings, all with an essentially clutter free display. When MultiScan is operated in automatic mode, every pilot has the weather information that is currently available only to the most experienced radar operator, thus standardizing and simplifying airline pilot training requirements. MultiScan significantly reduces pilot work load while at the same time enhancing weather detection capability and passenger/crew safety.

The key to MultiScan Operation is the radar's ability to look down, into ground clutter, toward the bottom reflective portion of a thunderstorm, and then eliminate the ground clutter with advanced digital signal processing. MultiScan also combines multiple radar scans at pre-selected tilt angles in order to detect short, mid, and long-range weather. The result is superior weather detection at all ranges in all phases of flight.

True 320 NM weather and OverFlight™ Protection are two of several new unique features of the MultiScan Radar. The ability of the MultiScan to eliminate ground clutter with advanced algorithms allows it to skim the radar horizon and provide pilots with true strategic weather out to 320 NM. OverFlight™ Protection allows crews to avoid inadvertent thunderstorm top penetrations, which today account for a significant portion of aircraft turbulence encounters. OverFlight™ Protection ensures that any thunderstorm that is a threat to the aircraft will remain on the radar display until it no longer poses a danger to the aircraft.

## SYSTEM DESCRIPTION

### KEY OPERATING FEATURES

Advanced Features include:

- **Fully Automatic Operation:** MultiScan is designed to work in the fully automatic mode. Pilots select only the desired range. Tilt and gain inputs are not required (♦page 4-12).

- **Essentially Clutter Free Display:** Rockwell Collins' third generation ground clutter suppression algorithms are utilized to eliminate approximately 98% of ground clutter resulting in the display of threat weather that is essentially free of ground clutter (♦page 4-14).
- **Optimized Weather Detection At All Ranges And Altitudes:** Weather data from multiple scans at varying tilt angles is stored in memory. When the flight crew selects a desired range, information from the various scans is extracted from memory and merged on the display. Since both long and short range weather information is available due to the use of multiple tilt angles, the display presentation represents an optimized weather picture regardless of the aircraft altitude or the range scale selected (♦page 4-22).
- **Strategic Weather:** MultiScan provides true 320 NM strategic weather information (♦page 4-25).
- **Gain *PLUS*™:** Gain *Plus* incorporates the following functions:
  - **Conventional Increase and Decrease of Gain Control:** MultiScan allows the flight crew to increase and decrease gain during both manual and automatic operation (♦page 4-35).
  - **Variable Temperature Based Gain:** Variable temperature based gain automatically compensates for low thunderstorm reflectivity during high altitude cruise (♦page 4-38).
  - **Path Attenuation Compensation and Alert (PAC Alert):** Compensation for attenuation due to intervening weather is provided within 80 NM of the aircraft. When compensation limits are exceeded, a yellow PAC Alert bar is displayed to warn the flight crew of an area of radar shadow (♦page 4-39).
  - **OverFlight™ Protection:** OverFlight protection reduces the possibility of inadvertent thunderstorm top penetration at high cruise altitudes. MultiScan's lower beam information and memory capability are utilized to prevent thunderstorms that are a threat to the aircraft from disappearing from the display until they pass behind the aircraft (♦page 4-40).
  - **Oceanic Weather Reflectivity Compensation™:** MultiScan automatically compensates for the reduced reflectivity of oceanic thunderstorms to provide a more accurate weather presentation during over water operations (♦page 4-43, ♦page 5-16).

- **Comprehensive Low Altitude Weather:** The use of multiple tilt angles at low altitude allows the radar to protect against vaulted thunderstorm energy by scanning along the aircraft flight path, scan for growing thunderstorms beneath the aircraft, and view weather at extended ranges (♦page 4-23).
- **Windshear Detection:** Automatic forward looking windshear detection is provided in that landing and take off environment (♦page 4-45).
- **Ground Mapping:** Ground mapping mode enables the detection of major geographical features such as cities, lakes and coast lines (♦page 4-34).
- **Split Function Control (Boeing Aircraft):** Split function control provides the captain and first officer with independent control of range, gain and mode of operation. When operating in manual mode, independent tilt control is also available (♦page 4-2).
- **Simultaneous Display Updates in All Range/Mode Combinations:** The captain's and first officer's displays update simultaneously during automatic operation even when different ranges and modes are selected (♦page 4-26).

This page intentionally left blank



---

**TABLE OF CONTENTS**

---

Title	Page
Thunderstorm Reflectivity .....	3-1
The Ideal Radar Beam .....	3-4
MultiScan Emulation of the Ideal Radar Beam .....	3-5
The MultiScan Process .....	3-6
Update Rates .....	3-7
Automatic Gain .....	3-8
The End Result .....	3-8

This page intentionally left blank

## ***THEORY OF OPERATION***

### ***THUNDERSTORM REFLECTIVITY***

Understanding thunderstorm reflectivity is the key to understanding how MultiScan works. In general, thunderstorm reflectivity can be divided into three parts (see figure 3-1).

*Figure 3-1 Thunderstorm Reflectivity Levels*

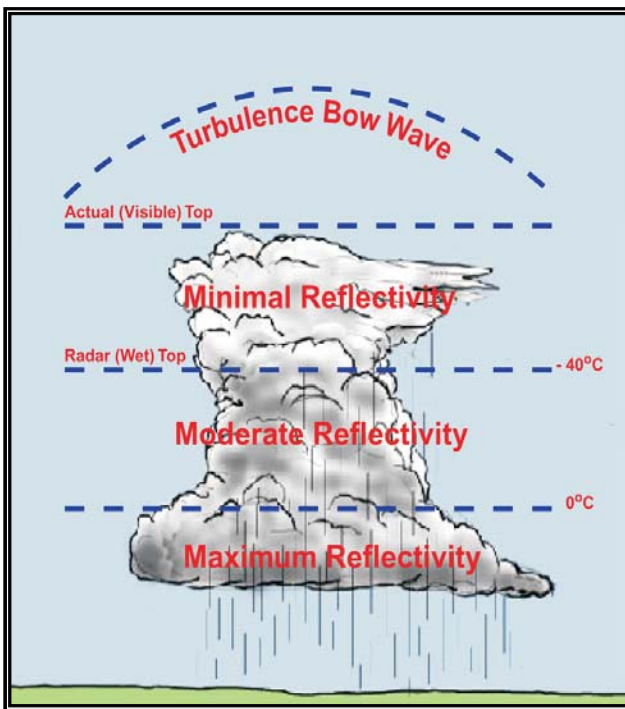

TPF9615\_03

The bottom third of the storm below the freezing level is composed entirely of water and is the part of the storm that most efficiently reflects radar energy. The middle third of the storm is composed of a combination of supercooled water and ice crystals. Reflectivity in this part of the storm begins to diminish due to the fact that ice crystals

are very poor radar reflectors. The top third of the storm is composed entirely of ice crystals and is almost invisible to radar. In addition, a growing thunderstorm may have a turbulence bow wave above the visible portion of the storm (♦page 5-5).

Figure 3-2 shows an actual thunderstorm. The pictures in figure 3-3 show the corresponding radar picture as tilt is increased. In practice, finding the proper tilt angle during manual operation often becomes a compromise between observing the most reflective part of the thunderstorm and reducing ground clutter returns (♦page 4-61, ♦page 5-6).

*Figure 3-2 Observed Thunderstorm*



TPG3130\_01

Figure 3-3 Observed Thunderstorm and Corresponding Radar Display at Varying Tilt Settings

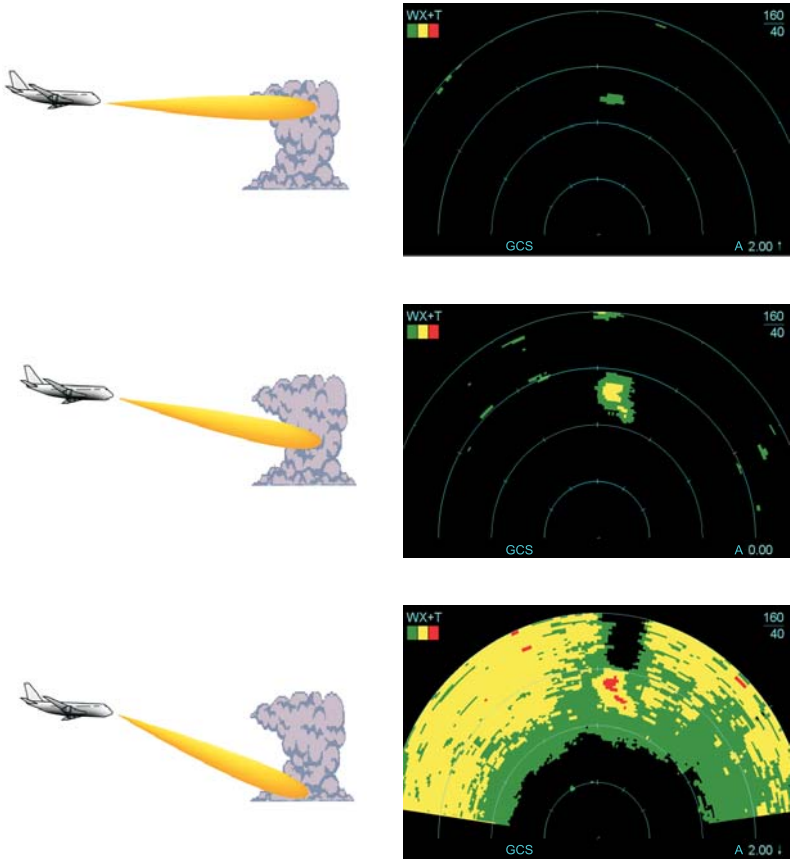

TPF9615\_02

## THE IDEAL RADAR BEAM

Understanding thunderstorm reflectivity and the effect that radar tilt angle has on it allows us to envision a hypothetical ideal radar beam for weather threat detection. The ideal radar beam would look directly below the aircraft to detect building thunderstorms and then follow the curvature of the earth out to the radar's maximum range (figure 3-4). Thus, the ideal beam would keep the reflective part of all significant weather in view at all times, from right at the aircraft out to 320 NM.

Figure 3-4 Ideal Radar Beam

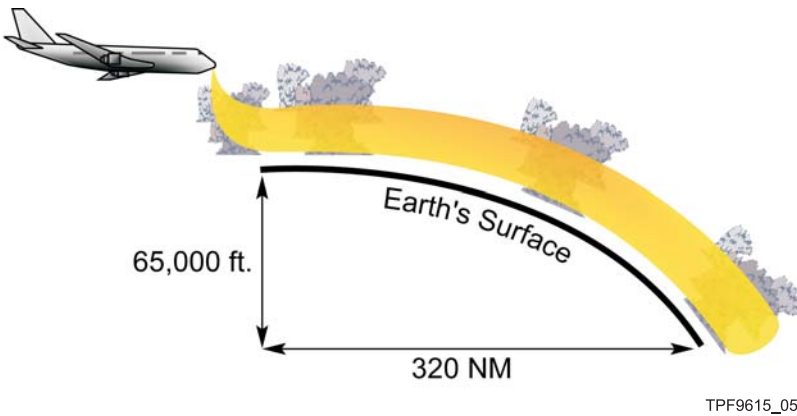

### NOTE

Note that the earth's curvature causes a drop of approximately 65,000 feet over a distance of 320 nautical miles.

## ***MULTISCAN EMULATION OF THE IDEAL RADAR BEAM***

MultiScan emulates an ideal radar beam by taking information from different radar scans and merging the information into a total weather picture. Rockwell Collins' patented ground clutter suppression algorithms are then used to eliminate ground clutter. The result is the ability for flight crews to view all significant weather from 0 to 320 NM on a single display that is essentially clutter free (figure 3-5).

*Figure 3-5 MultiScan Emulation of Ideal Beam*

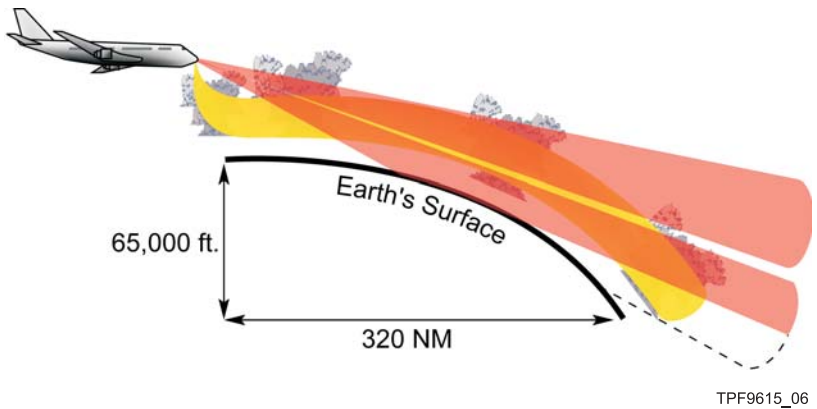

## THE MULTISCAN PROCESS

Figure 3-6 illustrates the MultiScan process. Two scans are taken, each optimized for a particular region in front of the aircraft. In general, the upper beam detects intermediate range weather while the lower beam detects short and long range weather by automatically adjusting the beams' tilt and gain settings (figure 3-7). The information is then stored in a temporary database. When the captain or first officer selects a range, the computer extracts the appropriate portions of the desired information, merges the data, then eliminates the ground clutter. The result is an optimized weather display for whichever range scale the flight crew selects.

Figure 3-6 The MultiScan Process

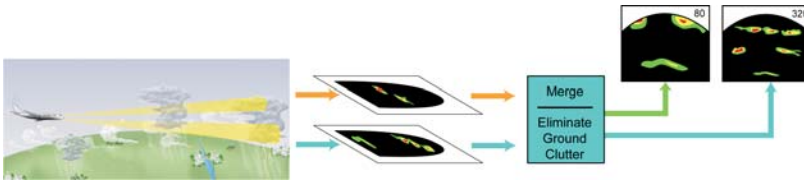

TPF9615\_07

Figure 3-7 MultiScan Upper and Lower Scan

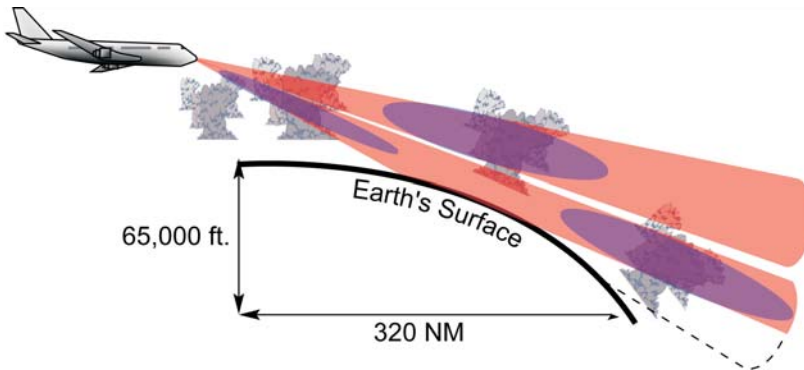

TPG3130\_02



## UPDATE RATES

The total time required to complete one cycle of the MultiScan process in all modes except windshear is 8 seconds. When in windshear mode, the total cycle time for both MultiScan and windshear is 11.2 seconds. Thus, there is no significant change to observed weather during one cycle of the MultiScan process. What does change is the relationship of the aircraft to the weather. To compensate for this, MultiScan **translates** (figure 3-8) and **rotates** (figure 3-9) the stored digital image to compensate for aircraft movement.

The result is that the Collins MultiScan updates all radar displays every four seconds in all modes except windshear, in which case the displays update every 5.5 seconds. One interesting element of this process is that the antenna scan is no longer tied to the display sweep. This frees the antenna to perform multiple functions without interrupting the pilot's weather presentation.

Figure 3-8 MultiScan Updates Image For Aircraft Movement

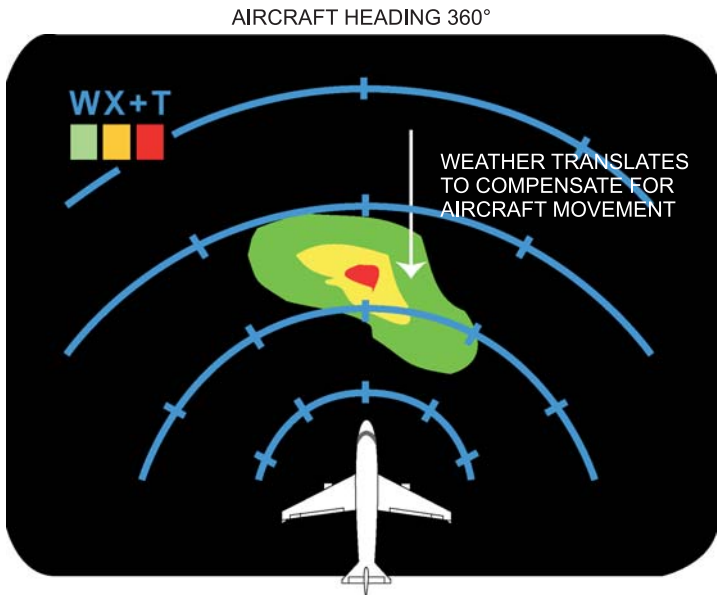

TPF9615\_94

Figure 3-9 MultiScan Updates Image After Heading Change

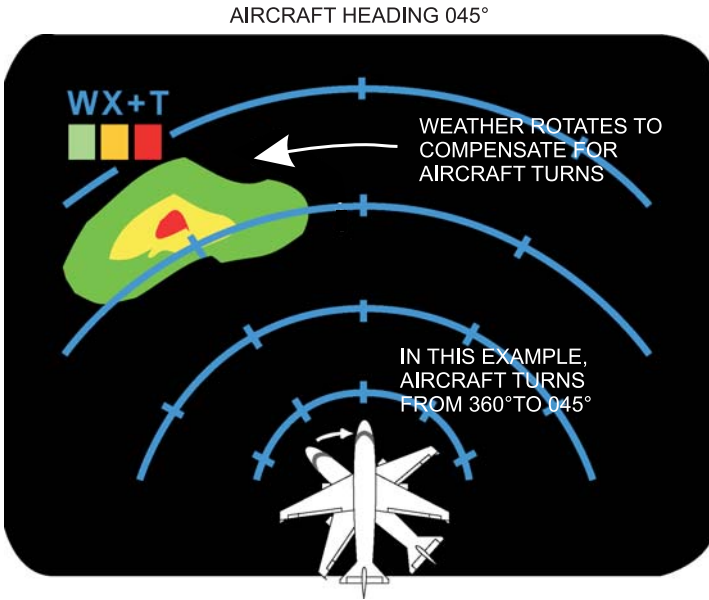

## **AUTOMATIC GAIN**

During automatic operation, MultiScan uses variable gain that is based on atmospheric temperature profiles to compensate for variations in geographic location, time of day, and altitude in order to optimize weather returns in all phases of flight (♦page 4-38). Gain is thus adjusted to suit the environment in which the aircraft is flying and provide the optimum weather picture in the prevailing conditions.

## **THE END RESULT**

Because MultiScan can examine the weather in front of the aircraft using multiple tilt settings and because the radar is able to look down into the ground clutter to pick out significant weather, MultiScan is able to display all the weather from 0 – 320 NM that will affect the aircraft on a single, essentially clutter-free display (figure 3-10). And the whole

process is entirely automatic, freeing the flight crew to concentrate on weather avoidance rather than weather detection and interpretation.

MultiScan is able to look down into ground clutter to detect the reflective portion of thunderstorms. Figure 3-10 shows the radar picture with the ground clutter suppression turned off. Weather is masked by the ground clutter.

*Figure 3-10 MultiScan Display With GCS Off*

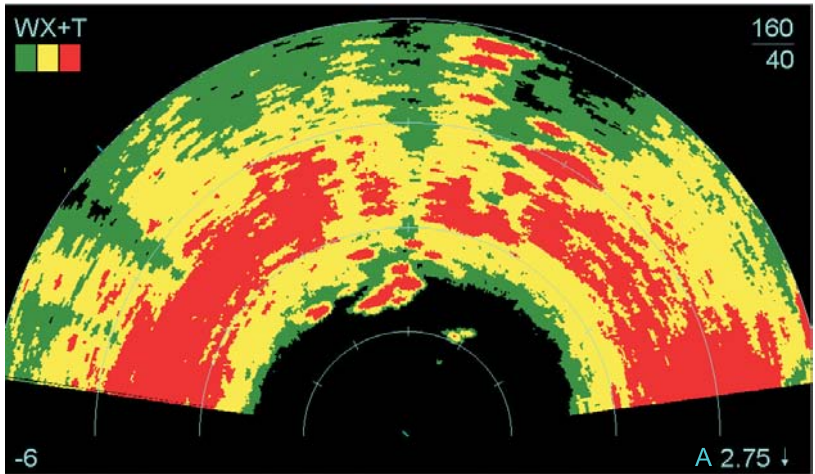

TPF9615\_04

Figure 3-11 demonstrates when Ground Clutter Suppression (GCS) is activated. All significant weather (in this case from right in front of the aircraft out to 160 NM) is visible on a single, essentially clutter-free display. Significantly, the radar no longer needs to compromise between a tilt that will eliminate ground clutter and a tilt that will give the best weather returns.

Figure 3-11 MultiScan Display With GCS On

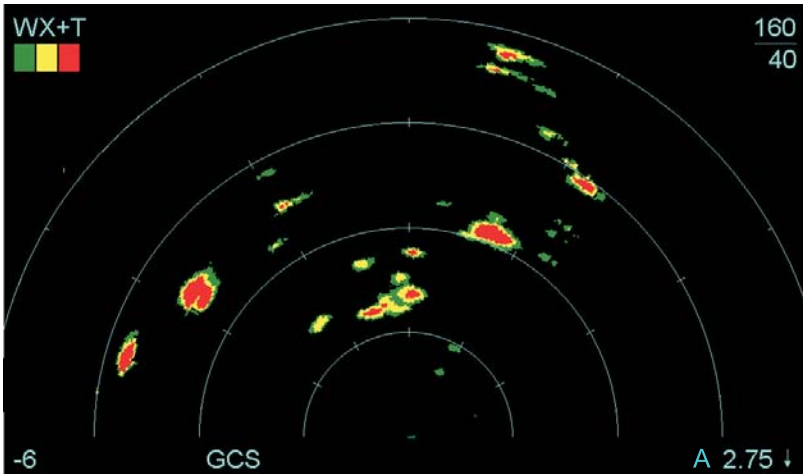

TPF9615\_01



**NOTE**

In the figure above, when Ground Clutter Suppression (GCS) is activated, all significant weather (in this case, right in front of the aircraft out to 160 NM) shows on a single, essentially clutter-free display.

## TABLE OF CONTENTS

Title	Page
MultiScan Control Panels .....	4-1
Airbus Control Panel .....	4-1
Boeing Control Panels .....	4-2
Display Annunciations .....	4-4
Airbus Display Annunciations .....	4-4
Boeing Display Annunciations .....	4-7
Retrofit Aircraft Display Annunciations .....	4-9
Tilt Annunciation (What Does It Mean During Automatic Operation?) .....	4-11
MultiScan Automatic Operation .....	4-12
General Controls .....	4-12
Power (On/Off) .....	4-12
Automatic Operation (On/Off) .....	4-13
Ground Clutter (On/Off) .....	4-16
Tilt Control (Inoperative During Automatic Operation) .....	4-17
Dual System Selection (For Aircraft Equipped with two R/Ts) .....	4-18
TFR (Transfer) – Boeing Only .....	4-20
Weather Detection .....	4-22
Weather Detection Characteristics During Automatic Operation .....	4-22
Modes of Operation .....	4-27
Gain PLUS™ (Available During Automatic Operation) .....	4-35
Windshear .....	4-45
Test .....	4-52
MultiScan Manual Operation .....	4-57
Manual Operation: Control Panel Inputs and Operating Procedures .....	4-57
Manual Operation (MAN/AUTO) .....	4-58
Ground Clutter (Inactive For Manual Operation) .....	4-60
Tilt Control .....	4-61
Over-scan Prevention – Pilot Techniques .....	4-72
Storm Height Estimation (Radar Top Only) .....	4-76
Long Range (Over the Horizon) Weather Detection .....	4-79
Gain .....	4-82
The Total Weather Picture .....	4-82

This page intentionally left blank

# MULTISCAN OPERATION

## MULTISCAN CONTROL PANELS

### AIRBUS CONTROL PANEL

The Airbus MultiScan control panel is a dual-system, single-function control panel. “Dual-system” refers to the fact that the radar system may contain one or two R/Ts, depending on aircraft configuration. “Single-function” means that mode, gain and tilt settings will be the same for both the Captain and First Officer.



#### NOTE

Tilt is functional only during manual operation.

Figure 4-1 Airbus Dual-System, Single-Function Control Panel, #622-5130-820

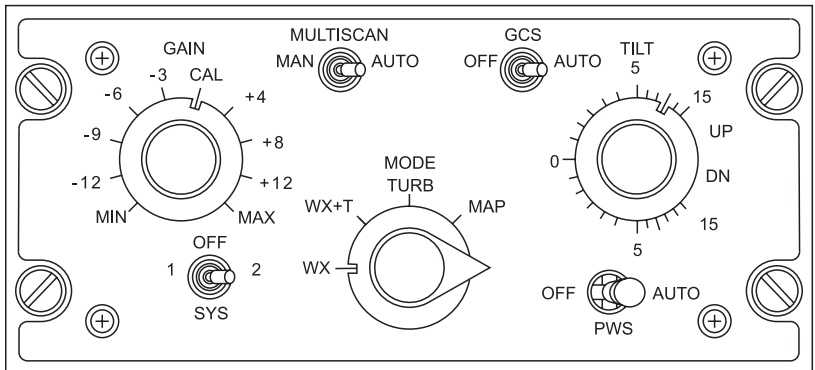

TPF9615\_09

## BOEING CONTROL PANELS

Boeing has a single-system (one R/T per aircraft configuration – see figure 4-2) and a dual-system (two R/T per aircraft configuration – see figure 4-3) control panel. Both control panels are “split-function” control panels. “Split function” means that the Captain and First Officer have independent control of mode, gain, and tilt (see figure 4-4).



### NOTE

Tilt is functional only during manual operation.

Figure 4-2 Boeing Single-System, Split-Function Control Panel  
#622-5129-801

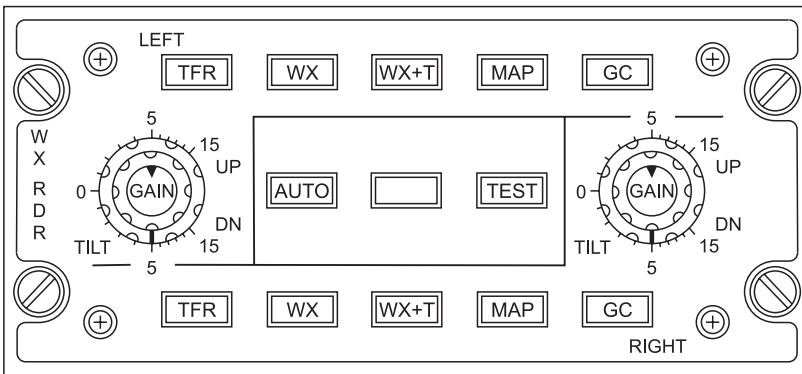

TPF9615\_10



Figure 4-3 Boeing Dual-System, Split-Function Control Panel #622-5130-801

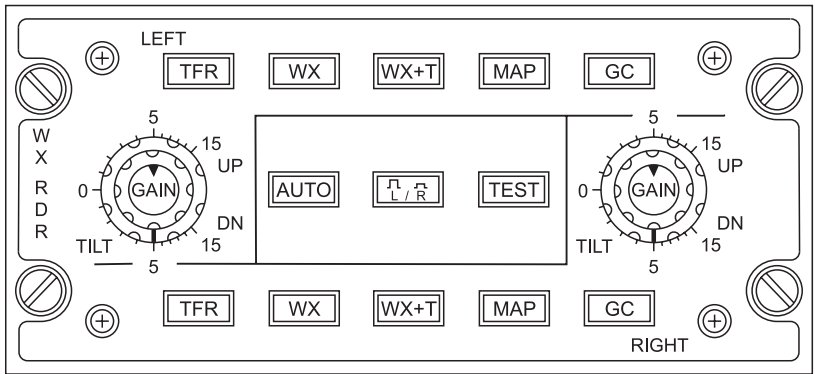

TPF9615\_11

A split-function control panel provides the captain and first officer independent control of mode, gain, and tilt. In figure 4-4, the **Tan** area represents the captain's controls; the **Blue** area represents the first officer's controls.

Figure 4-4 Boeing Split-Function Control Areas

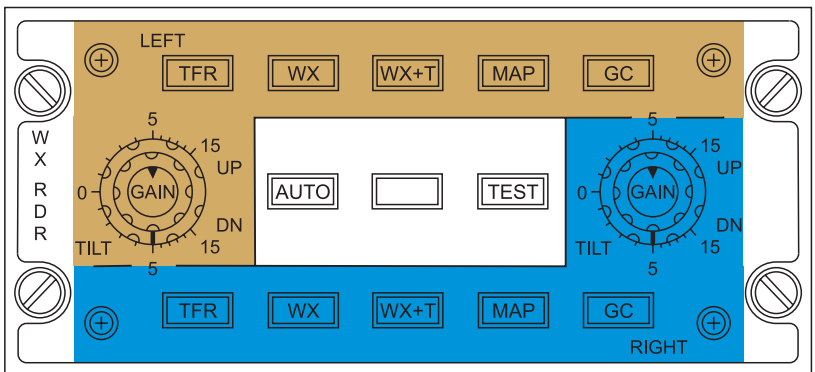

TPF9615\_12

## **DISPLAY ANNUNCIATIONS**

### **AIRBUS DISPLAY ANNUNCIATIONS**

Automatic operation is considered to be the standard mode of operation on **Airbus** aircraft. Therefore, there is no EFIS indication when the automatic MultiScan function is selected. During manual operation, **MAN** appears on the EFIS display by the tilt code.

The top picture in figure 4-5 shows that **AUTO** is selected because the  $-1.5^\circ$  tilt code has no indication in front of it. **MAN GAIN** is displayed because the gain is in some position other than **CAL** (calibrated). The bottom picture in figure 4-5 shows that Manual is selected because **MAN** shows in front of the  $+2.0^\circ$  tilt code. **CAL** (calibrated) gain is selected since the **MAN GAIN** indication is not present.

#### **NOTE**



When the radar fails in the **AUTO** mode, the tilt field will indicate either an **A-15**, **A-15.5**, or **A-16** value with an associated display fail message (i.e., **WXR SYS** or **AUTOTILT FAIL**). Switch the radar to the **MAN** mode and operate per standard procedures.

Figure 4-5 Airbus Automatic and Manual Operation Annunciations

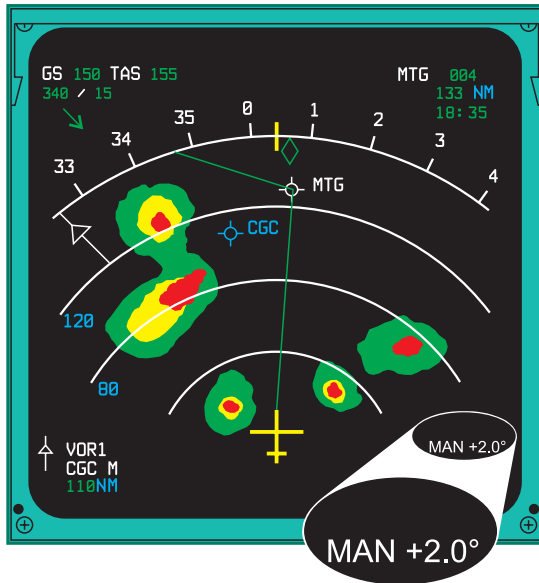
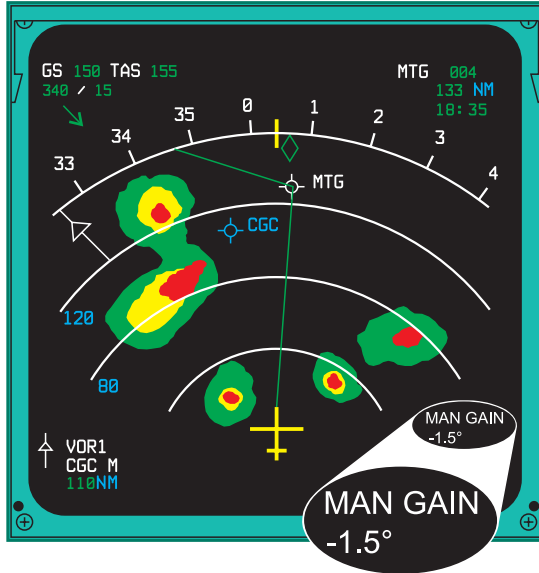

TPG3130\_03

Should the automatic function fail, weather will not show and **NO AUTOTILT** will be displayed (figure 4-6) until the automatic function is deselected by the flight crew (♦page 4-13).

Figure 4-6 Airbus Automatic Function Fail Annunciation

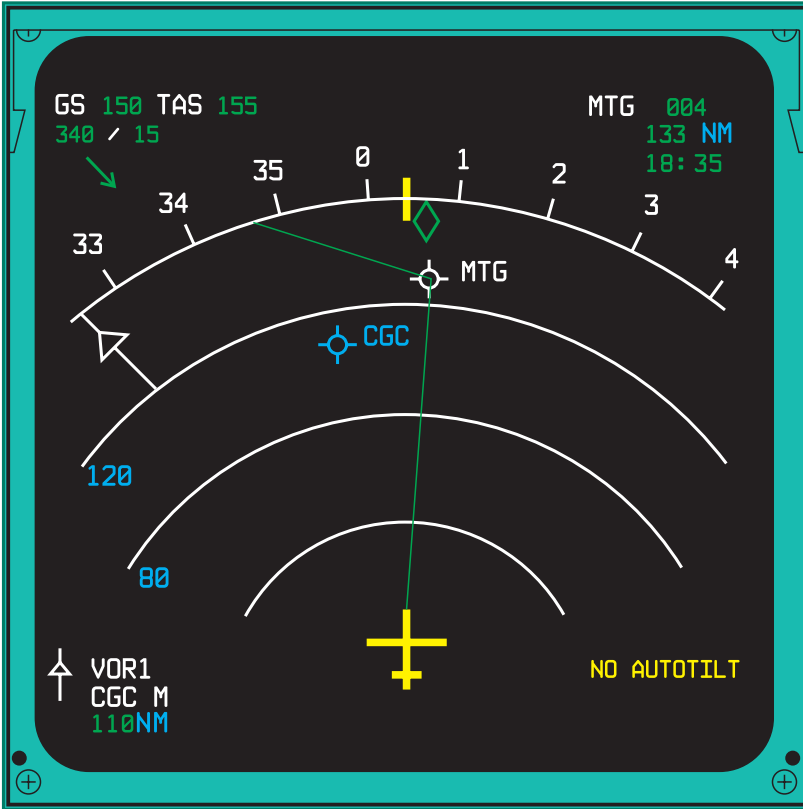

TPF9615\_13

## ***BOEING DISPLAY ANNUNCIATIONS***

On Boeing aircraft, an **A** will show on the EFIS by the tilt code during automatic operation (see the top picture in figure 4-8). An **M** will show during manual operation (see the bottom picture in figure 4-8).

The top picture in figure 4-7 shows that radar mode WX+T (weather plus turbulence) is selected, +5° of tilt is displayed and the radar is in the **A**(automatic) mode. **VAR** indicates gain is either above or below the **CAL** (calibrated) gain position. The bottom picture in figure 4-7 shows that radar mode WX+T is selected, +2° of tilt is selected and the radar is in the **M** (manual) mode. The absence of any gain annunciation indicates that **CAL** gain is selected.



### **NOTE**

On Boeing aircraft, messages other than **VAR** may be displayed, depending on the selected customer options.

Figure 4-7 Boeing Automatic and Manual Operation Annunciations

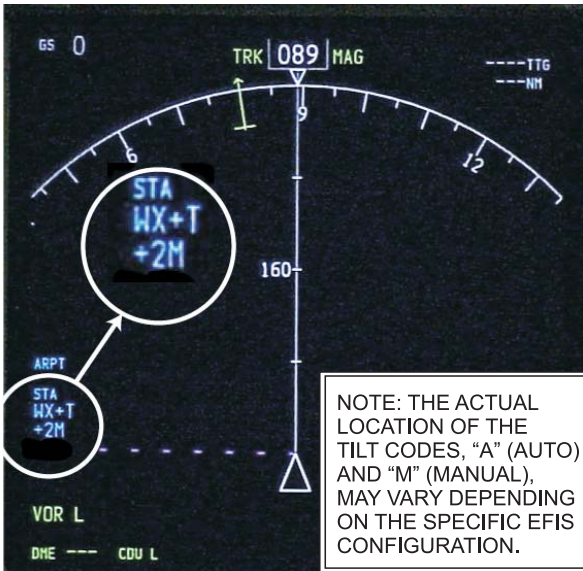

TPG3130\_04

## **RETROFIT AIRCRAFT DISPLAY ANNUNCIATIONS**

If the EFIS of a retrofit aircraft has not been updated so that it is able to display automatic and manual annunciations (♦page 4-4, ♦page 4-7), the following annunciations will be provided by the radar:

For retrofit installations, automatic MultiScan operation is considered to be the standard mode of operation. Therefore, there is no EFIS indication when the automatic MultiScan function is selected. During manual operation **M** is displayed in the bottom right hand corner of the display (see figure 4-8).

*Figure 4-8 Retrofit Manual Operation*

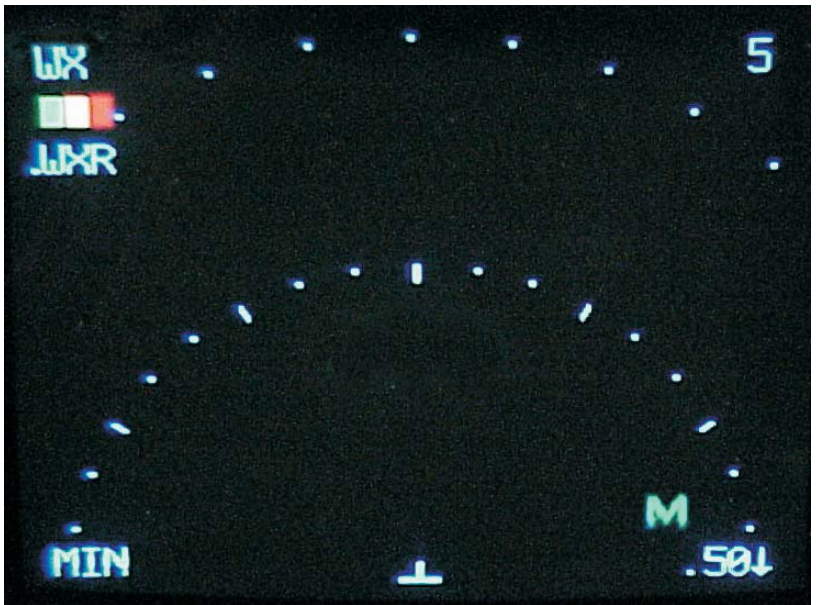

TPF9615\_15

Should the automatic function fail, weather will not be displayed and **NO AUTOTILT** will be displayed (see figure 4-9) until the automatic function is deselected by the flight crew.

Figure 4-9 Retrofit Automatic Function Fail Annunciation



TPF9615\_16



**NOTE**

A windshear annunciation preempts the **M** (manual) and **NO AUTOTILT** annunciations.



## ***TILT ANNUNCIATION (WHAT DOES IT MEAN DURING AUTOMATIC OPERATION?)***

During automatic operation on both Airbus and Boeing aircraft, the tilt displayed on the EFIS represents an average of the lower and upper beam tilts. For instance, during take off the lower and upper beams are 4° apart. The lower beam is set to 3°, the upper beam is set to 7° and the displayed tilt is 5°. As the aircraft climbs the difference between the beams decreases. At 10,000 feet AGL and higher, the difference between the upper and lower beams is approximately 2°.



### **NOTE**

On EFIS display systems that indicate TILT as a whole number, there may be a difference in the TILT value between the Captain and First Officer NAV DISPLAY due to rounding in the display system.

## MULTISCAN AUTOMATIC OPERATION

MultiScan is designed for fully automatic operation. For **automatic operation**, select the **automatic function and the desired range**. Once in automatic mode, the radar adjusts tilt and gain to provide an optimum weather picture for any range scale or flight condition.

### GENERAL CONTROLS

#### POWER (ON/OFF)

**Airbus:** Power is applied to the radar when the **SYS** (system) switch is selected to **1** or **2**. Power is removed from the system when the **SYS** switch is in the **OFF** position.



#### NOTE

For Airbus aircraft, a dual system control panel is used for both single and dual R/T aircraft configurations. In a single R/T configuration, the **SYS** switch position **2** is inactive.

Figure 4-10 Airbus Control Panel

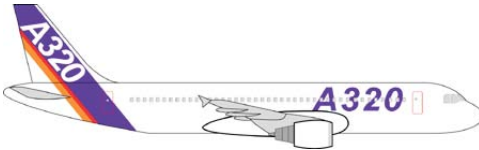
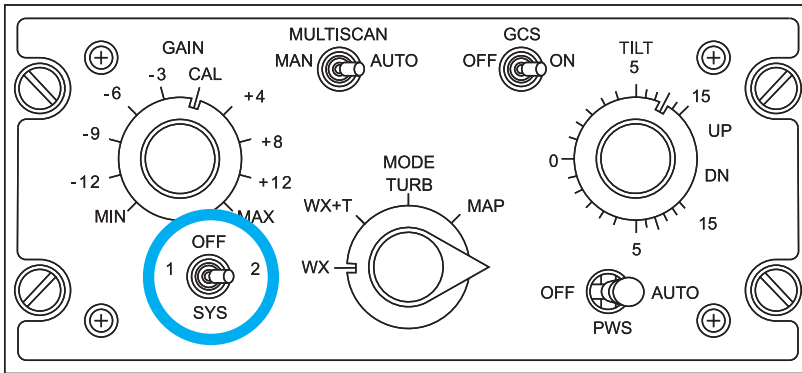

TPG3130\_05

**Boeing:** Power is applied to the radar by selecting **WXR** on the EFIS control panel.

### ***AUTOMATIC OPERATION (ON/OFF)***

**Airbus:** Automatic operation is activated for both the Captain and First Officer by moving the **MULTISCAN MAN/AUTO** switch to the **AUTO** position (figure 4-11). When the **MULTISCAN MAN/AUTO** switch is selected to **MAN**, both pilots are in manual and the controls will function as described in the Manual Operation section (♦page 4-57).

*Figure 4-11 Airbus MULTISCAN MAN/AUTO Control*

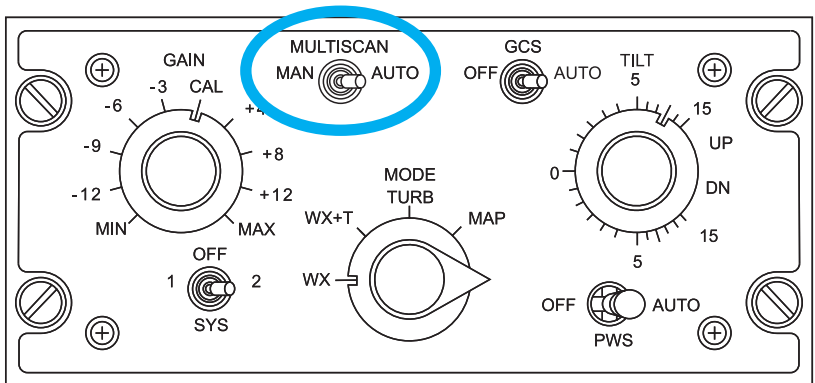

TPF9615\_17

**Boeing:** The MultiScan **AUTO** button (figure 4-12) switches between manual mode and automatic mode. The **AUTO** button is a latching alternate action switch. When the **AUTO** button is pushed in, both the Captain and the First Officer are in MultiScan automatic mode. When the button is in the out position, both pilots are in manual and the controls will function as described in the Manual Operation section (♦page 4-57).

Figure 4-12 Boeing AUTO Control

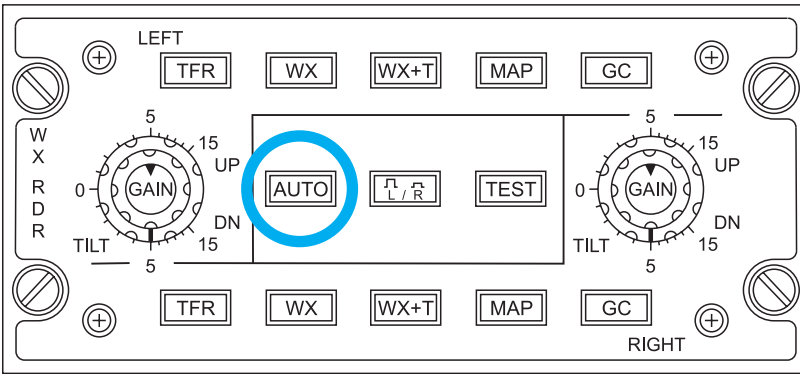

TPF9615\_18



**NOTE**

When automatic is selected, both the Captain and First Officer will be in automatic. When manual is selected, both will be in manual. It is not possible for one pilot to be in automatic and the other one to be manual.

When automatic is initially selected, the radar will first make a sweep that looks along the aircraft's flight path. This ensures that weather directly in front of the aircraft will be immediately visible to the flight crew. The second sweep will be at a relatively low tilt angle. Significant ground clutter may be visible. The ground clutter suppression algorithms begin to have affect during the second sweep of the antenna and will be fully initialized by the beginning of the fifth sweep (16 seconds). When the initialization process is complete, the flight crew will receive an optimized weather picture with minimal ground clutter for any range scale selected (♦page 4-22). In addition, OverFlight™ protection (♦page 4-40) will be fully engaged to prevent thunderstorms that are a threat to the aircraft from falling below the radar beam (figure 4-13).

Figure 4-13 MultiScan Initialization Process

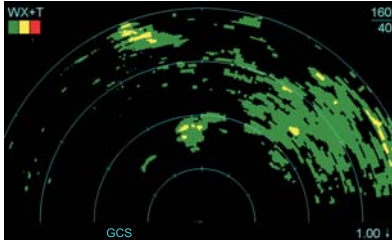

RADAR IN MANUAL PRIOR TO INITIALIZATION OF AUTOMATIC FUNCTION.

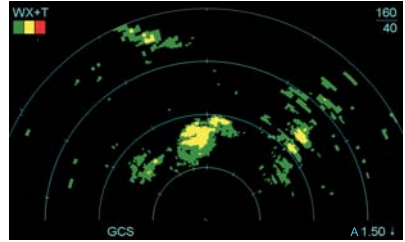

FIRST ANTENNA SWEEP. THREAT WEATHER VISIBLE.

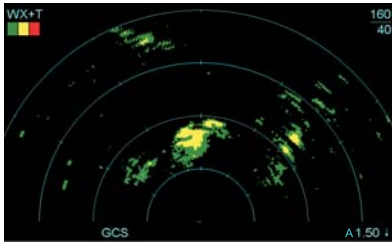

SECOND ANTENNA SWEEP. INITIALIZATION PROCESS BEGINS.

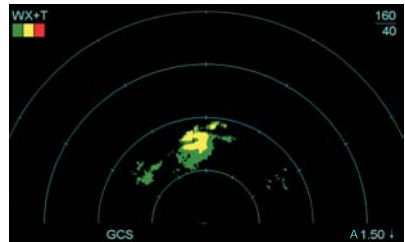

THIRD ANTENNA SWEEP. INITIALIZATION PROCESS CONTINUES.

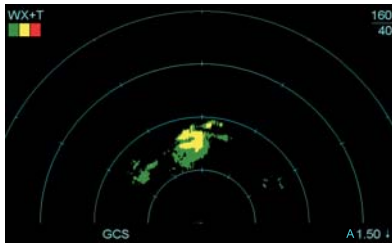

FOURTH ANTENNA SWEEP. INITIALIZATION PROCESS CONTINUES.

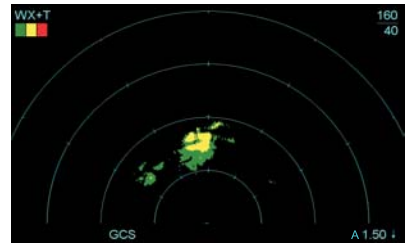

FIFTH ANTENNA SWEEP. INITIALIZATION PROCESS COMPLETE.

TPG3130\_06



**NOTE**

MultiScan has a “coast” feature that allows the pilot to momentarily switch to manual, then back to automatic. If the pilot switches from auto to manual, then returns to auto within 38 seconds, the radar will remember the automatic settings and will not need to re-initialize.

### **GROUND CLUTTER (ON/OFF)**

Ground Clutter Suppression (GCS) is enabled during MultiScan AUTOMATIC operation (♦page 4-12). This is the default position for both **Airbus and Boeing** aircraft. On occasion, flight crews may want to momentarily override the ground clutter suppression feature for navigation purposes without reverting to manual operation.

**Airbus:** To observe ground returns, move the **GCS** switch from **AUTO** to **OFF**. The switch is spring loaded and will return to the **AUTO** position when released.

Figure 4-14 Airbus GCS Control

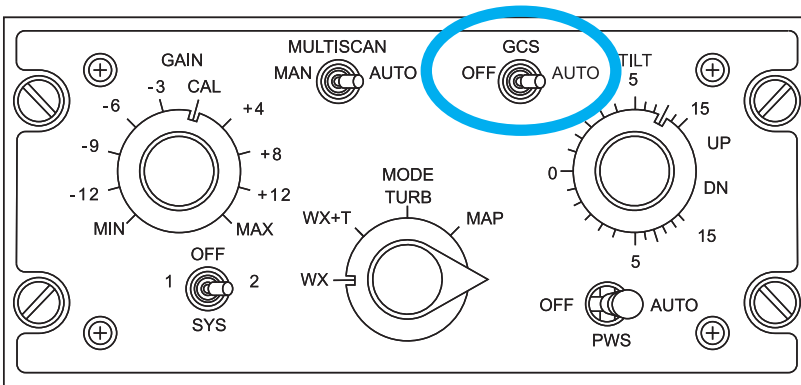

TPF9615\_29

**Boeing:** To observe ground returns, press and hold the **GC** (Ground Clutter) button. The button is a momentary switch and the radar will return to the default **GCS** mode when it is released.

Figure 4-15 Boeing GC Control

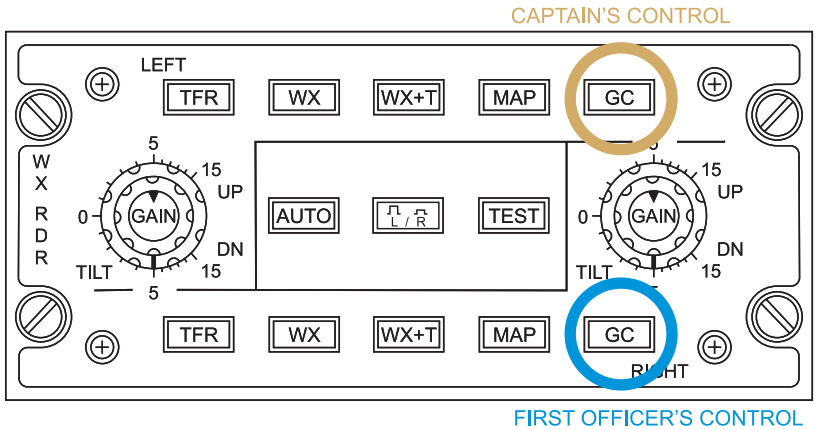

TPF9615\_30

**TILT CONTROL (INOPERATIVE DURING AUTOMATIC OPERATION)**

During MultiScan automatic operation, the **TILT** controls are not active. The **TILT** setting displayed on the EFIS represents the average between the upper and lower beams (♦ page 3-6).

Figure 4-16 Airbus TILT Control

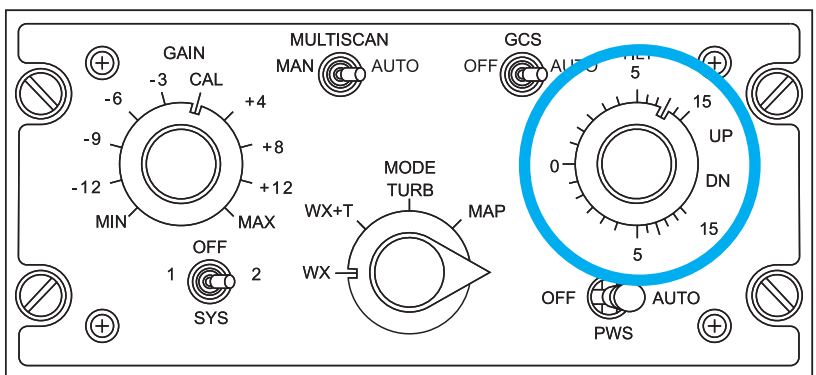

TPF9615\_27

Figure 4-17 Boeing TILT Control

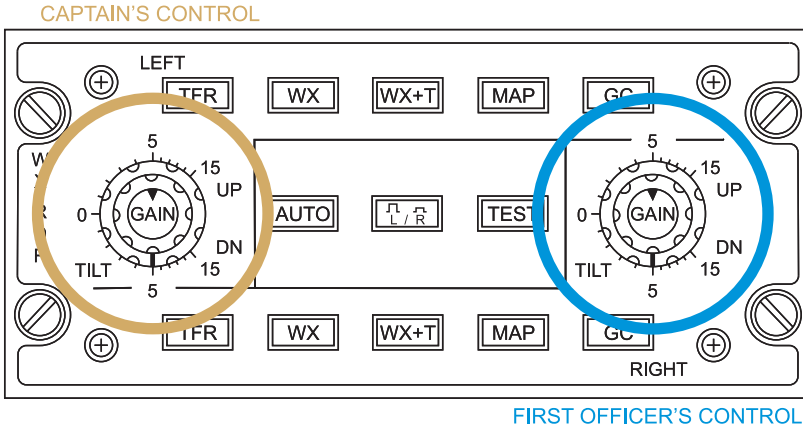

TPF9615\_28

### **DUAL SYSTEM SELECTION (FOR AIRCRAFT EQUIPPED WITH TWO R/Ts)**

Dual system selection allows the flight crew to switch between R/Ts in an aircraft with a dual R/T configuration.

**Airbus:** The **SYS** switch allows the flight crew to select either the number 1 system (left R/T) or the number 2 system (right R/T). The **OFF** position removes power from the radar system.



Figure 4-18 Airbus (Single & Dual R/T Configurations)

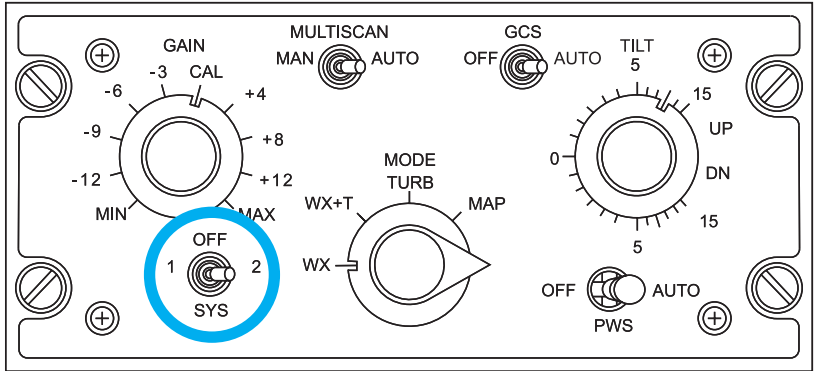

TPF9615\_19



**NOTE**

For Airbus aircraft, a dual system control panel is used for both single and dual R/T aircraft configurations. In a single R/T configuration, the **SYS 2** switch position is inactive.

**Boeing:** The **L/R** button selects either the left or right R/T. The button is an alternate action latching design. When the button is depressed, the right system is selected. When the button is out, the left system is selected. The silk-screen label on the **L/R** button provides a visual indication as to which R/T is selected. For single R/T systems, there is no L/R select button.

Figure 4-19 Boeing (Dual R/T Configuration Only)

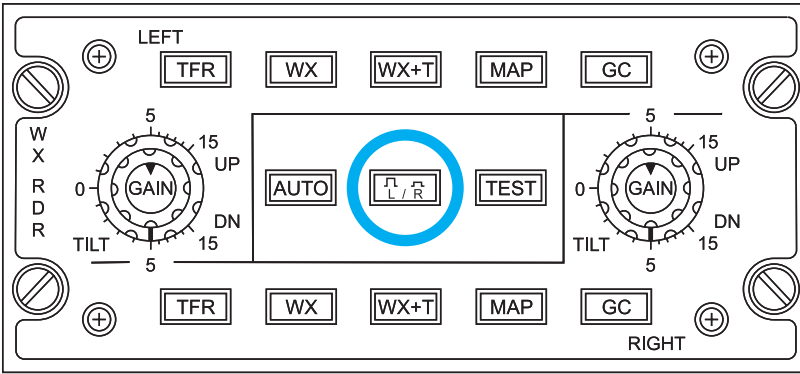

TPF9615\_20



**NOTE**

For Boeing aircraft, power to the radar is applied to the system through the **WXR** button on the EFIS control panel.

**TFR (TRANSFER) – BOEING ONLY**

**Boeing:** The **TFR** button allows the Captain or First Officer to select all of the control settings from the opposite side except range. Therefore, if the First Officer presses the **TFR** button, the First Officer's radar control settings and display will be slaved to the Captain's settings. Conversely, if the Captain presses the **TFR** button, all control settings and display will be slaved to the First Officer's side. This function works for both **AUTO** and **Manual** modes of operation. During **Manual** operation, the **TFR** includes slaving of the **TILT** value selected on the opposite side.

Figure 4-20 Boeing Transfer Control

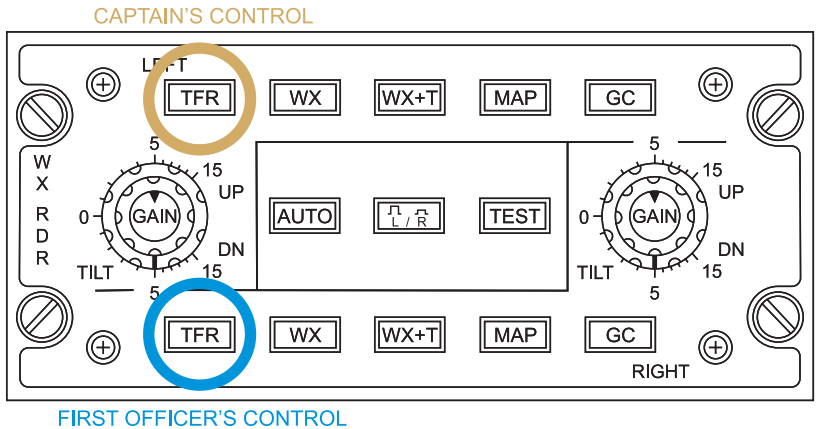

TPF9615\_31



**WARNING**

Do not operate the Weather Radar system with both the left **TFR** push button and right **TFR** push button selected at the same time. The MODE, GAIN, and TILT of the system can no longer be determined by viewing the control panel. In most system configurations, the Weather Radar will default to the test mode until one of the **TFR** buttons is deselected.



**NOTE**

If both pilots select **TFR**, the radar will not be able to determine which settings to use (the Captain's or First Officer's) to supply information to the EFIS. If this occurs, the radar will display a radar test pattern on the EFIS (♦page 4-55).

## ***WEATHER DETECTION***

### ***WEATHER DETECTION CHARACTERISTICS DURING AUTOMATIC OPERATION***

#### ***OPTIMIZED WEATHER PRESENTATION AT ALL RANGES***

Because MultiScan emulates an ideal radar beam (♦page 3-5), the entire weather picture from 0-320 NM is stored in computer memory. Furthermore, since ground clutter is eliminated with computer algorithms there is no need to compromise between a tilt angle that eliminates ground clutter and a tilt angle that gives the best weather picture (♦page 5-6). The pilot simply selects the desired range scale and that portion of the optimum weather presentation is displayed on the weather radar display.

Figure 4-21 Optimized Weather at Various Ranges

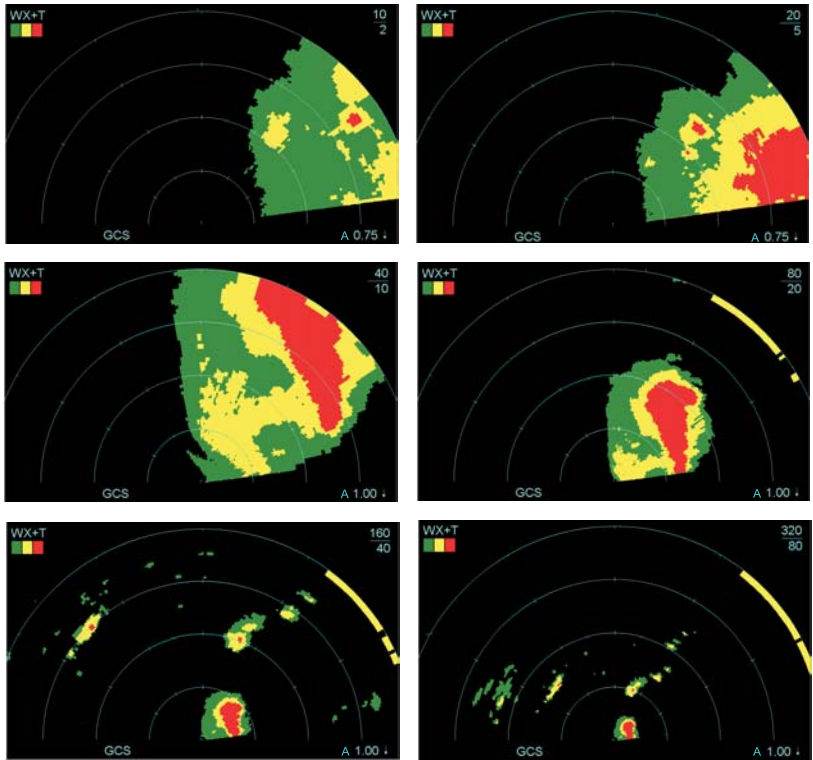

TPG3130\_07

### **EXTENDED RANGE LOW ALTITUDE WEATHER & PROTECTION FROM VAULTING**

During low altitude operation MultiScan uses multiple beams at different tilt settings and ground clutter suppression, allowing the radar to protect against thunderstorm vaulting (♦page 5-15) while simultaneously viewing weather at far greater ranges than is currently possible. The upper beam looks along the aircraft flight path during climb out to protect against thunderstorm vaulting while the lower beam uses a lower than traditional tilt angle to view short and intermediate range weather (figure 4-22).

Figure 4-22 MultiScan Low Altitude Operation



TPF9615\_50

Figure 4-23 Extended Range Weather Example

TAKE OFF FROM CEDAR RAPIDS, IA. THE RADAR IS IN MANUAL. TILT IS SET +7° UP IN ORDER TO LOOK ALONG THE AIRCRAFT CLIMB OUT FLIGHT PATH. WEATHER DETECTION IS ESSENTIALLY LIMITED TO 20 NM.

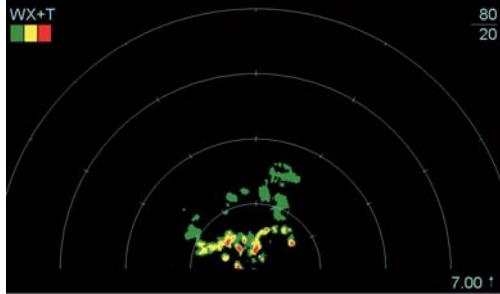

WHEN AUTOMATIC IS SELECTED THE 20 NM IMMEDIATE THREAT WEATHER REMAINS CLEARLY VISIBLE BUT EXTENDED RANGE WEATHER OUT TO 80 NM IS ALSO AVAILABLE.



TPG3130\_08

### **STRATEGIC WEATHER OUT TO 320 NM**

Because MultiScan is able to select the best tilt angle for weather detection, then eliminate the ground clutter through digital signal processes, the radar is able to skim the radar horizon (see figure 4-75) and automatically provide a strategic weather picture out to 320 NM.

Figure 4-24 shows how MultiScan utilizes a tilt angle that skims the radar horizon in order to be able to detect long range weather (♦page 4-79).

*Figure 4-24 MultiScan Tilt for Long Range Scan*

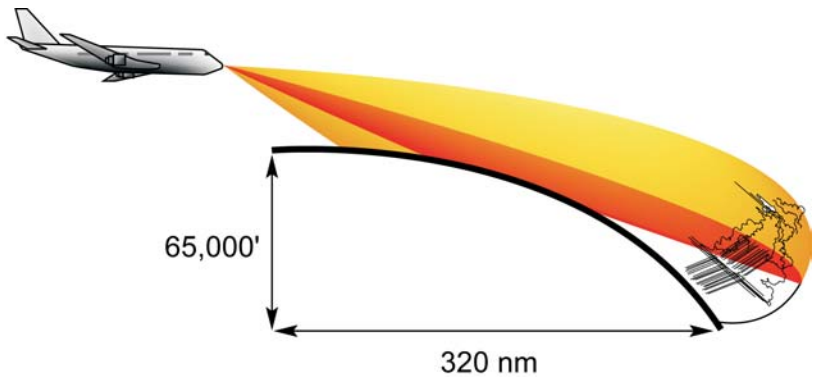

TPF9615\_48

In figure 4-25, MultiScan clearly shows a line of thunderstorms out to 300 NM. Note the dog leg in the storm just beyond 160 NM that is only visible on the 320 NM range scale.

Figure 4-25 MultiScan 320 NM Strategic Weather Display

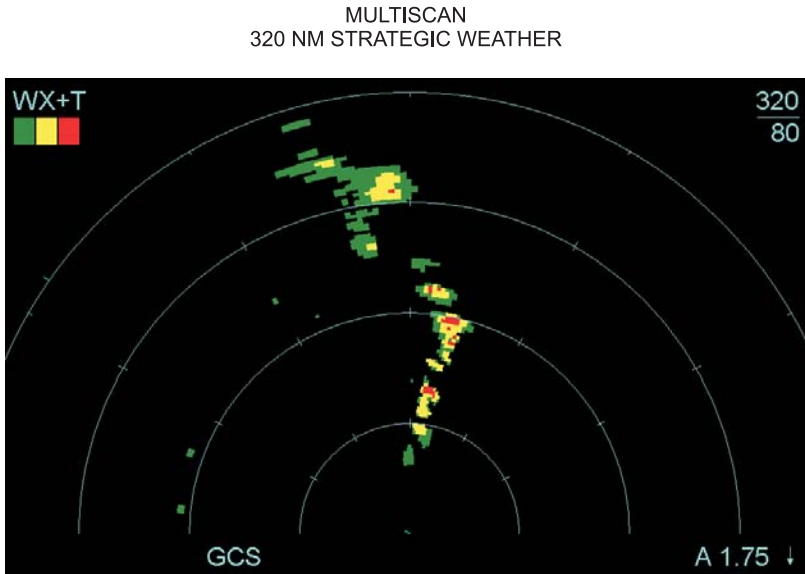

TPF9615\_49

### ***SIMULTANEOUS DISPLAY UPDATES IN ALL RANGE/MODE COMBINATIONS***

MultiScan updates all cockpit displays simultaneously even when different ranges and modes are selected by the captain and first officer. The display is updated every four seconds for all modes except windshear, which is updated every 5.5 seconds. The result is rapid and continuous update of all weather information.



## MODES OF OPERATION

### WX (WEATHER MODE)

**WX** (Weather) Mode (figures 4-26 and 4-27) enables display of weather targets without turbulence information. When in MultiScan **AUTO** Mode, the Weather display will essentially be free of ground clutter, thus enabling rapid and accurate interpretation of weather hazards.

Figure 4-26 Airbus WX Control

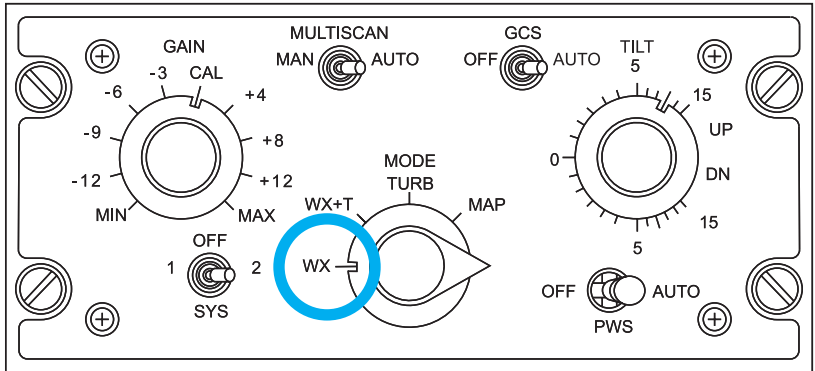

TPF9615\_32

Figure 4-27 Boeing WX Control

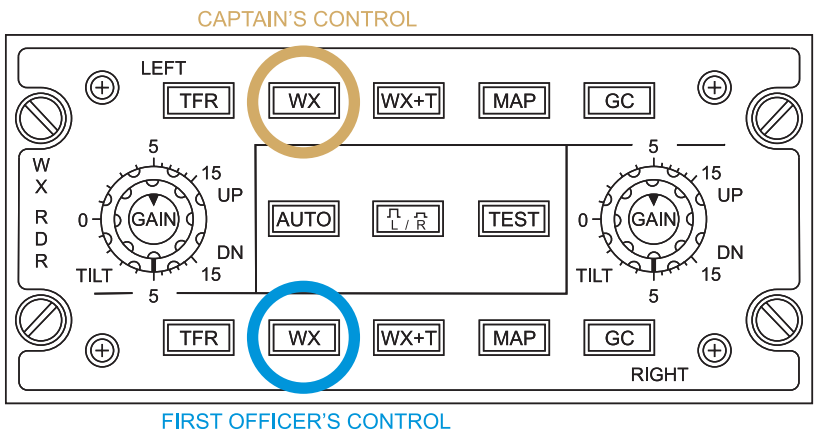

TPF9615\_33

In figure 4-28, WX (weather) mode is selected. The four colors displayed (black, green, yellow, red) represent different storm intensities (page 4-35). Note that GCS (ground clutter suppression) has been activated (i.e., MultiScan is operating in the fully automatic mode) and that the weather display is essentially free of ground clutter.

Figure 4-28 Weather Mode (WX) Typical Display

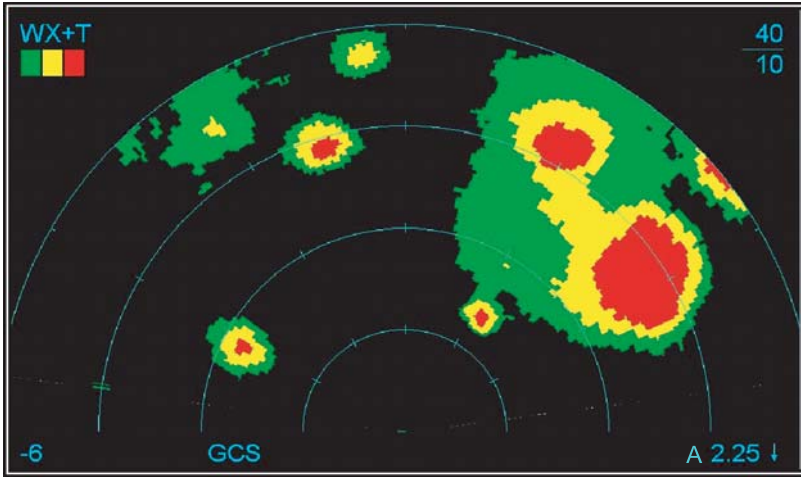

TPF9615\_34

## WX+T (WEATHER PLUS TURBULENCE MODE)

### WARNING

Doppler turbulence detection relies on the presence of at least light precipitation. It is not capable of detecting clear air turbulence.

**WX+T** (Weather Plus Turbulence) Mode enables display of weather targets with turbulence information overlaid on the display. Turbulence will be displayed in **magenta** out to 40 nautical miles (figure 4-31) for all selected ranges (figure 4-32). When in the MultiScan AUTO Mode, the Weather plus Turbulence display will be essentially free of ground clutter, which enables rapid and accurate interpretation of weather hazards.

Figure 4-29 Airbus WX+T Control

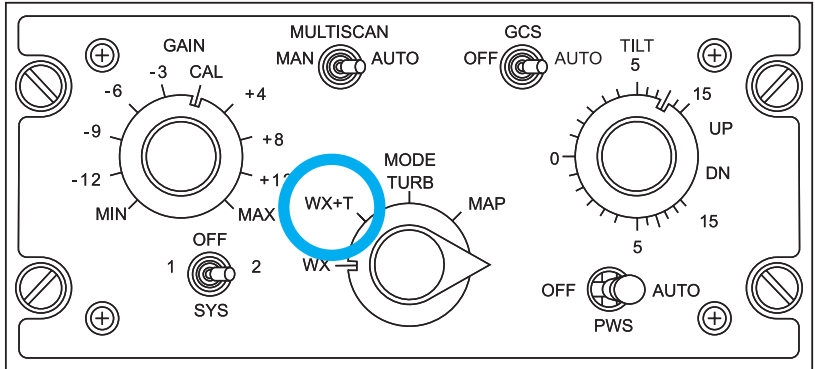

TPF9615\_35

Figure 4-30 Boeing WX+T Control

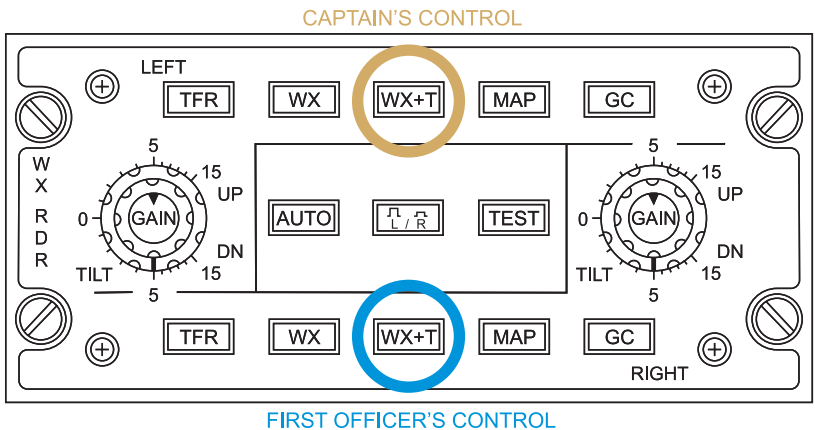

TPF9615\_36



**NOTE**

Turbulence may be displayed on the black background color in areas where green levels of precipitation are not present.



**NOTE**

“Improved Turbulence” has been incorporated into the MultiScan radar. Improvements to the turbulence algorithm yield fewer false alerts and human factors improvements yield a more readable display.

Figure 4-31 depicts weather plus turbulence displayed on the 40 NM range scale. Five colors are present: black, green, yellow, red and magenta (♦page 4-35). Magenta indicates turbulence (♦page 4-35, ♦page 6-32).

*Figure 4-31 Weather Plus Turbulence Mode At 40 NM Range*

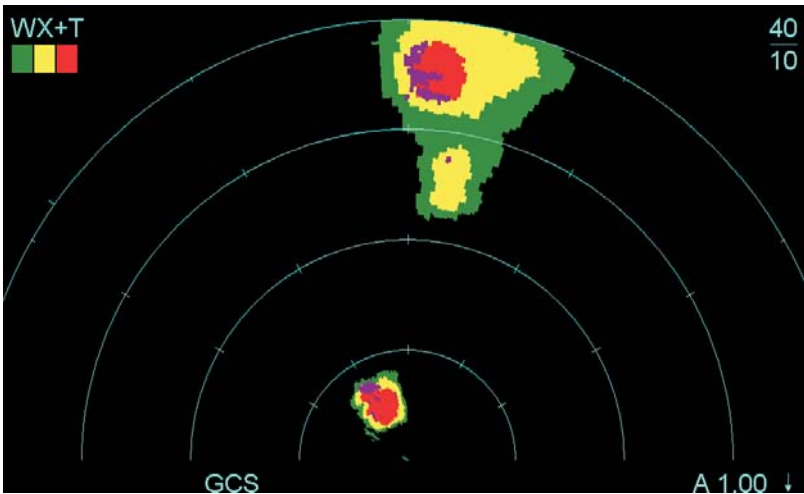

TPF9615\_37

Figure 4-32 depicts the same turbulence that is displayed in figure 4-31, but this time on the 80 NM range scale. Remember, turbulence will only be displayed out to 40 NM.



### WARNING

Because the radar determines turbulent areas by measuring precipitation velocity, it can only function in the presence of precipitation. Consequently, the system is not capable of detecting clear-air turbulence.

Figure 4-32 Weather Plus Turbulence Mode At 80 NM Range

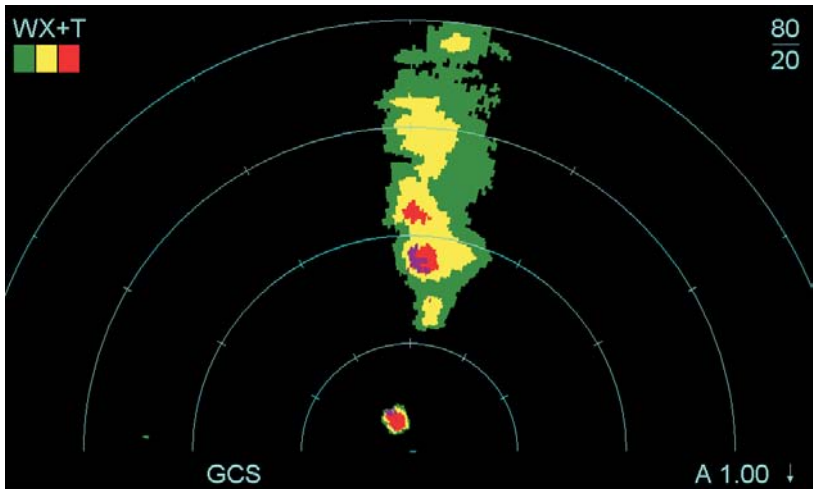

TPF9615\_38

### **TURB (TURBULENCE MODE) — AIRBUS ONLY**



### CAUTION

Precipitation will not show when operating in **TURB** mode. Inadvertent penetration of areas of severe weather is possible.

**TURB** (Turbulence Only) Mode displays only turbulence information without weather (figure 4-34). During automatic operation, ground clutter will also be removed. Turbulence is displayed out to 40 nautical miles for all selected ranges.

Figure 4-33 Airbus TURB Control

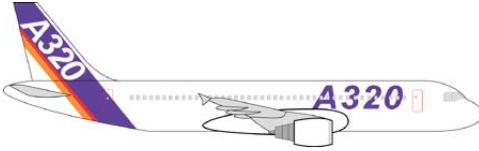
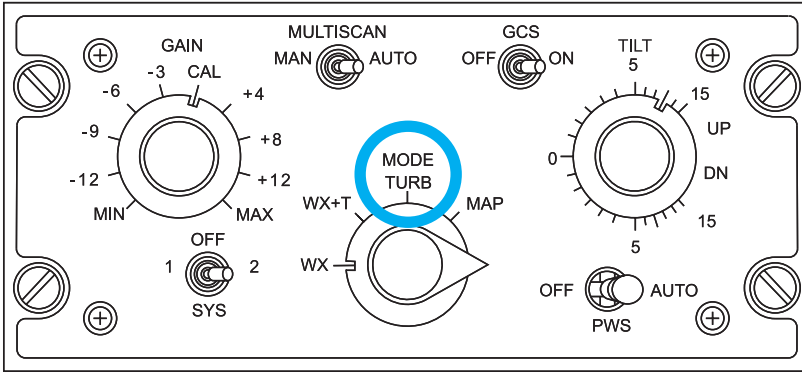

TPF9615\_41

Figure 4-34 TURB (Turbulence Only) Mode Display

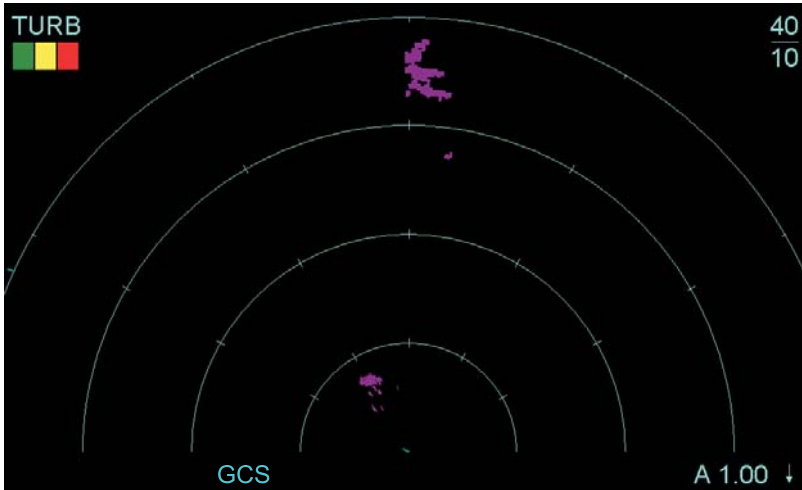

TPF9615\_40

## MAP

When operating in automatic, MAP mode enables display of all radar echoes including terrain and weather information (figure 4-37). The receiver sensitivity is decreased by approximately 10 dB (one color level) to accommodate terrain characteristics instead of weather. This mode enables identification of terrain features such as mountains, coastlines, bodies of water etc. No turbulence information is displayed. PAC Alert (♦page 4-39) is not active in MAP mode.

Figure 4-35 Airbus MAP Control

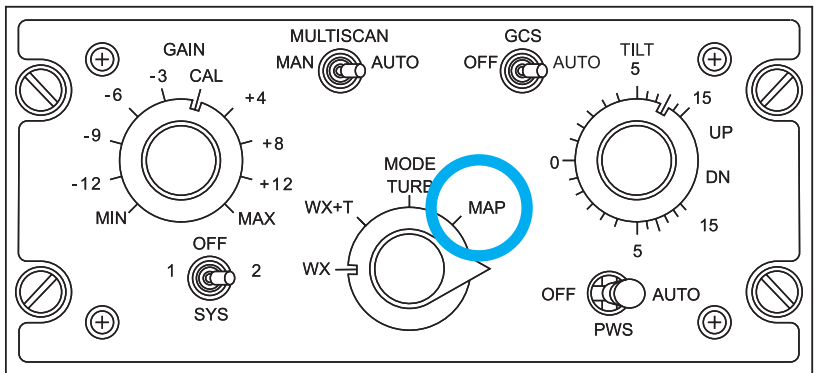

TPF9615\_42

Figure 4-36 Boeing MAP Control

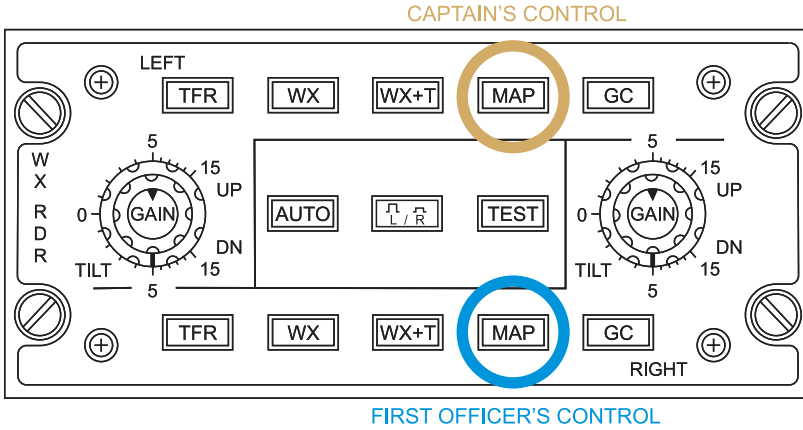

TPF9615\_43

Figure 4-37 shows that Lake Michigan, Chicago and the immediate vicinity are clearly displayed when MAP mode is selected. The radar is in automatic mode.

Figure 4-37 Map Mode Typical Display

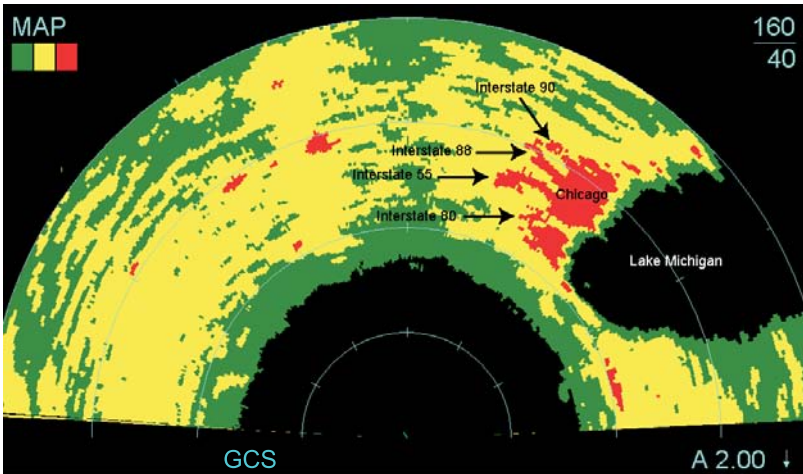

TPF9615\_44





## NOTE

Below 10,000 feet, manual operation of the radar will be required for adequate ground mapping due to the position of the beams (♦page 4-23). When operating the radar manually, careful tilt selection is required in order to properly identify ground targets. Tilt should be varied until an optimum return is displayed.

## **GAIN PLUS™ (AVAILABLE DURING AUTOMATIC OPERATION)**

During automatic operation the WXR-2100 MultiScan radar provides **Gain PLUS**, which includes:

- Conventional increase and decrease of receiver sensitivity
- Variable Temperature Based Gain
- PAC Alert
- OverFlight Protection
- Oceanic Weather Reflectivity Compensation™

## **CONVENTIONAL INCREASE AND DECREASE OF RECEIVER SENSITIVITY**

In general, weather radar measures the reflectivity of water content in the atmosphere. When the **CAL** (calibrated) gain position is selected:

- **Black** represents zero to minimal reflectivity.
- **Green** represents light reflectivity.
- **Yellow** represents moderate reflectivity.
- **Red** represents heavy to extreme reflectivity.
- **Magenta** indicates turbulence.



## NOTE

A more in depth discussion of reflectivity and gain can be found in the chapters AVIATION WEATHER and HOW RADAR WORKS.

The **CAL** (calibrated) gain setting yields the most accurate correlation of color levels (black, green, yellow and red) with actual rainfall rates and their corresponding thunderstorm threat levels. **CAL gain is the recommended gain position for normal operation.** Figure 4-38 shows a radar display with gain set to **CAL**.

Figure 4-38 GAIN Set to CAL

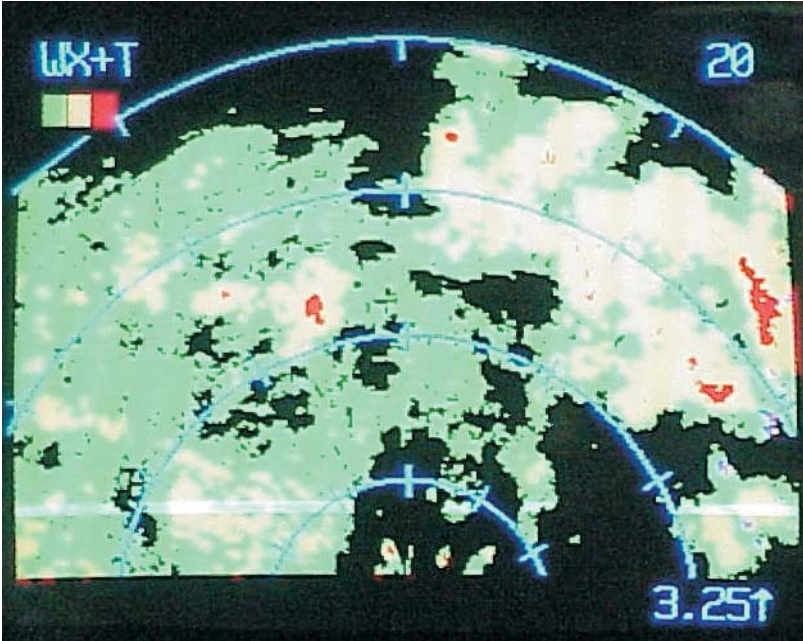

TPF9615\_25

During automatic operation rotating the gain knob clockwise increases receiver sensitivity. **MAX** gain (figure 4-39) is selected when the gain knob is rotated fully clockwise and represents an approximately one and a half color level increase in the color of the displayed weather (♦page 6-4). Consequently, if weather is present, green or yellow returns may appear in areas that were originally black, green returns will be displayed as either yellow or red, and a yellow return will be displayed as red.



**NOTE**

In oceanic regions, some island or sea clutter may be displayed when the **MAN GAIN** is set above **CAL**.

Figure 4-39 GAIN Set to **MAX**

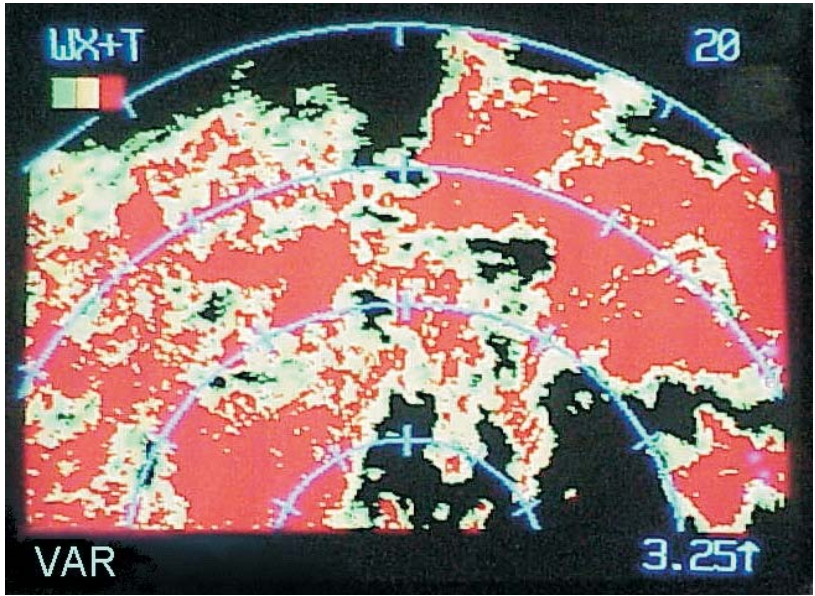

TPF9615\_24

During automatic operation rotating the gain knob counterclockwise decreases receiver sensitivity. **MIN** gain (figure 4-40) is selected when the gain knob is rotated fully counterclockwise and represents an approximately one and a half color level decrease in the color of the displayed weather (♦page 6-4). Consequently, red returns may be displayed as yellow or green, yellow returns will be displayed as green or disappear entirely, and green returns will no longer be displayed.

Figure 4-40 GAIN Set to **MIN**



TPF9615\_26

**CAUTION**

Always return gain to **CAL** after a below gain setting has been used. Gain settings below may cause thunderstorms to appear less intense than is actually the case (♦page 6-8).

Note that if a thunderstorm remains red when **MIN** gain is selected it indicates a storm exhibiting extreme reflectivity and is potentially a substantial threat to the aircraft. However, the radar should only be operated at the **MIN** gain position for short periods of time to help identify thunderstorm cores and areas of extreme reflectivity. The gain control should then be returned to the calibrated position. With gain set to **MIN** it is possible that a thunderstorm that just crosses the red color threshold will be displayed as green. Using **MIN** gain exclusively thus increases the possibility of inadvertent thunderstorm penetration.

**VARIABLE TEMPERATURE BASED GAIN**

During automatic operation MultiScan uses variable gain based on atmospheric temperature profiles to compensate for variations in

geographic location, time of day and altitude so as to optimize gain settings and weather returns in all phases of flight. Gain is held constant below the freezing level. As the aircraft ascends through the freezing level and the temperature decreases below 0° C, gain is increased. When temperatures fall below -40° C cloud tops are composed entirely of ice crystals and exhibit minimal reflectivity (♦page 5-5). Variable temperature based gain increases the gain by approximately one color level in this region to provide more accurate high altitude weather returns.

### ***PATH ATTENUATION COMPENSATION (PAC) ALERT***

If intervening rain fall creates an attenuated area, sometimes known as a radar shadow (♦page 6-27), PAC Alert places a yellow arc on the outer most range scale to warn the pilot of the attenuated condition (figure 4-41). PAC Alert is operative whenever the radar is being operated in **CAL** gain and the aircraft is within 80 NM of a thunderstorm.



#### **WARNING**

**NEVER FLY INTO A RADAR SHADOW!**



#### **CAUTION**

PAC Alert is disabled for all non-**CAL** settings.



#### **NOTE**

PAC Alert is activated during both automatic and manual radar operation.

Figure 4-41 PAC Alert on Weather Display

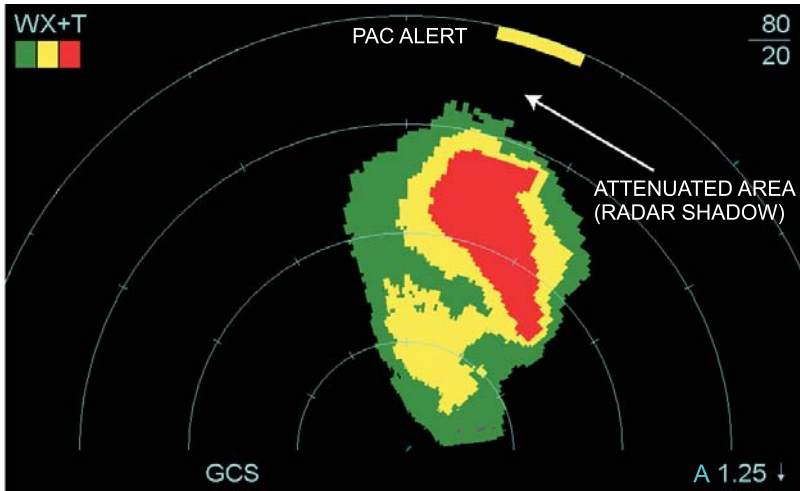

TPF9615\_54

## OVERFLIGHT PROTECTION

Current generation radars tend to over-scan the reflective portion of thunderstorms (♦page 5-5) at cruise altitudes. When this occurs, the actual thunderstorm top may still be in the aircraft flight path and inadvertent penetration of a storm top is possible. Figure 4-42 shows traditional manual operation of the radar and illustrates this phenomena. In the first picture the air crew has selected an 80 NM range scale and adjusted tilt to place ground clutter in the outer most range scale (♦page 4-69). Two cells are clearly visible (circled) at 60 NM. In the second picture, the 40 NM range scale has been selected and the thunderstorm cells are now at 30 NM. Note that as the aircraft nears the thunderstorms the radar beam narrows and begins to move higher into less reflective areas of the cells. As a result, the intensity of the storms is decreased and the returns appear as green cells only. In the third picture the wet top (radar top) of the storms have fallen below the radar beam and the cells have disappeared entirely from the radar display although the actual (visual) top remains in the aircraft flight path.

Figure 4-42 Pitfalls of Over-Scanning Thunderstorms

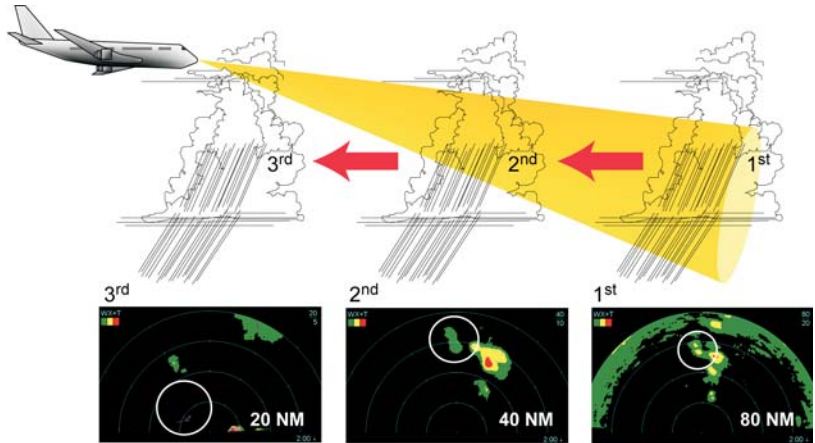

TPG3130\_10

OverFlight protection is designed to prevent thunderstorms that are in the aircraft flight path from falling below the radar beam and off the radar display during high altitude cruise. At extended ranges the upper radar beam scans the wet, reflective portion of a thunderstorm in the same manner that conventional radars scan weather today. As the aircraft approaches the storm and the cell begins to fall below the upper radar beam, MultiScan utilizes 6,000 feet of bottom beam information to keep the reflective part of the storm in view. Within approximately 15 NM of the aircraft MultiScan compares the stored digital image of the thunderstorm with the latest sweep information and displays whichever return is greater. If a cell that is a threat to the aircraft begins to fall below the radar beam MultiScan displays the stored digital image (figure 3-6) of the storm, thus ensuring that any threat thunderstorm will remain on the display until it moves behind the aircraft. OverFlight protection is operational above 22,000 feet MSL.

Figures 4-43 through 4-46 illustrate OverFlight functionality. Compare the MultiScan weather returns with the manual returns in figure 4-42 for a clearer understanding of OverFlight benefits.

Figure 4-43 Wet Top of Thunderstorm in Upper Beam

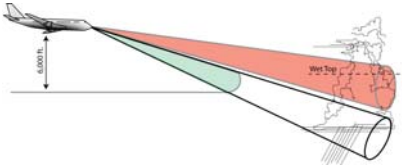

WET TOP OF THUNDERSTORM  
IN UPPER BEAM

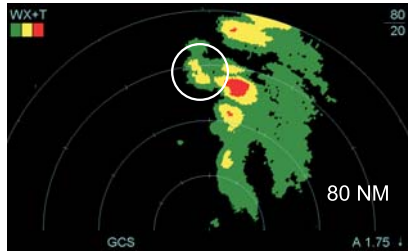

TPG3130\_11

Figure 4-44 Wet Top of Thunderstorm in Lower Beam

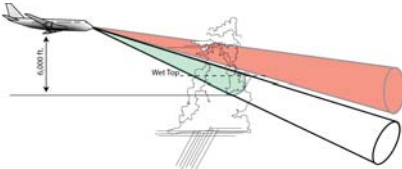

WET TOP OF THUNDERSTORM  
IN LOWER BEAM

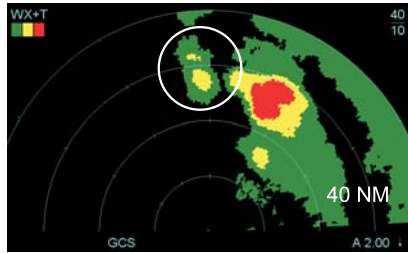

TPG3130\_12

Figure 4-45 Wet Top of Thunderstorm in Memory

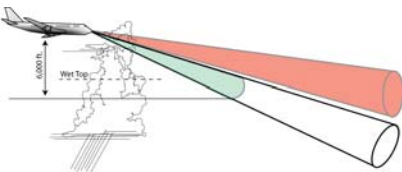

WET TOP OF THUNDERSTORM  
IN MEMORY

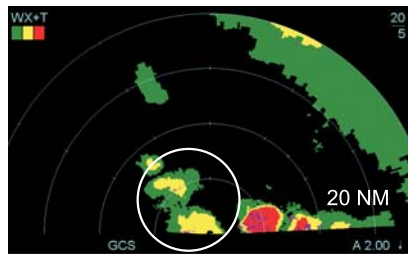

TPG3130\_13



Figure 4-46 OverFlight Protection to 22,000 Feet

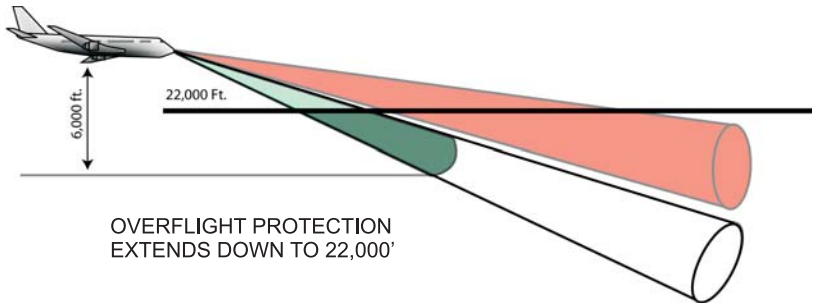

TPG3130\_14

### **OCEANIC WEATHER REFLECTIVITY COMPENSATION™**

During automatic operation the MultiScan radar uses aircraft navigation inputs to identify oceanic regions and adjusts gain and tilt to account for the decreased reflectivity of oceanic thunderstorms (♦page 5-16). Thunderstorm thresholds are adjusted to more accurately represent the true thunderstorm threat to the aircraft.

### **GAIN CONTROLS**

**Airbus:** Move the **GAIN** knob to the **CAL** detent (figure 4-47) to select calibrated gain. Sensitivity is increased by rotating the knob clockwise from the **CAL** position. Sensitivity is decreased by rotating the knob counter clockwise from the **CAL** position (♦page 6-8).

There is no EFIS indication for **CAL** gain because **CAL** gain is the standard gain setting. The EFIS will display MAN or MAN GAIN, depending on the aircraft display configuration, when gain is either increased or decreased from the **CAL** position (♦page 4-4).

Figure 4-47 Airbus GAIN Control

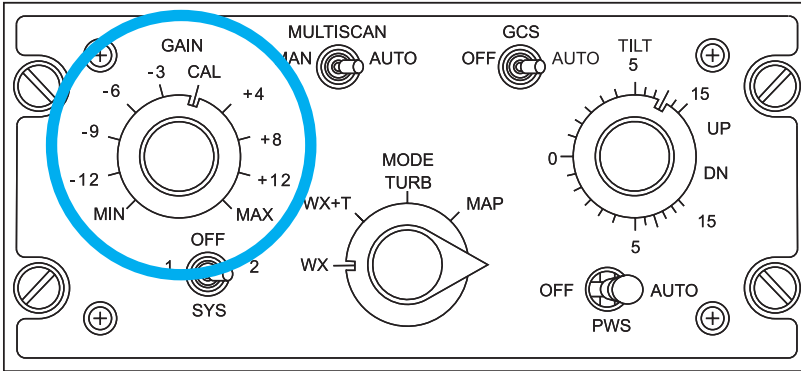

TPF9615\_22

**Boeing:** Move the black triangle (▼) on the GAIN knob to the 12 o'clock position to select **CAL** gain. Sensitivity is increased by rotating clockwise from the **CAL** position. It is decreased by rotating counter clockwise from the **CAL** position (♦page 6-8).

There is no EFIS indication for **CAL** gain because **CAL** gain is the standard gain setting. The EFIS will display **VAR** when gain is set above or below the **CAL** gain position (♦page 4-7).

Figure 4-48 Boeing GAIN Control

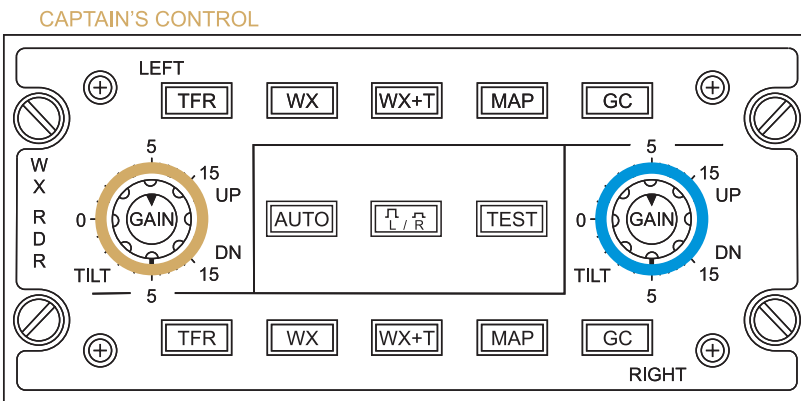

FIRST OFFICER'S CONTROL

TPF9615\_23



## NOTE

During oceanic flight, increasing gain above **CAL** may allow sea and island clutter to be displayed.

## WINDSHEAR

### WINDSHEAR DETECTION

Below 2,300 feet the weather scan switches from a 180° scan to a 120° scan, which indicates the windshear detection system is activated. Windshear alerts are displayed in the cockpit at 1,200 feet and below (figure 4-49).



## NOTE

The 120° weather scan below 2,300 feet provides rapid weather and windshear updates, and allows weather and windshear to be displayed simultaneously during the entire windshear event.

Windshear detection is always activated when the aircraft is below 2,300 feet and the proper qualifier logic has been met (i.e., in the takeoff and landing environment (♦page 6-35) even when the radar is turned off. The only exception occurs for Airbus aircraft when the **PWS OFF/AUTO** switch is selected to **OFF** (♦page 4-52).



## NOTE

Windshear detection is activated during both manual and automatic radar operation.



## NOTE

If the radar is on, but in the **MAP** or **TEST** mode, and the system detects a windshear event, the system display will automatically change to the **WX+T** mode to display the weather and windshear icons. The selected range does not change automatically.

Figure 4-49 Windshear Alert and Displays

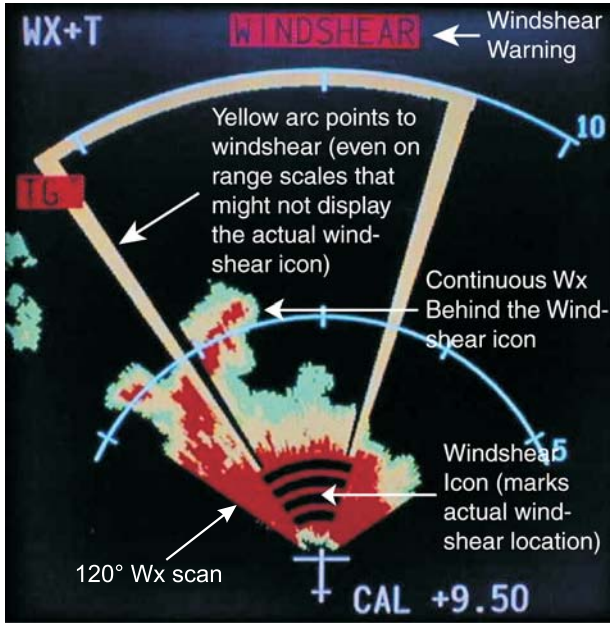

TPF9615\_51

### **WINDSHEAR DETECTION REGION**

The WXR-2100 MultiScan radar provides 60° windshear coverage (30° either side of aircraft heading) out to 3 NM for Boeing aircraft and out to 5 NM for Airbus and retrofit aircraft. Coverage varies slightly during the approach/go-around and takeoff phases of flight.

### **AIRBUS/RETROFIT AIRCRAFT**

#### **WARNING**

If a windshear warning alert occurs, the flight crew should follow the recommended airline/aircraft procedure for Go-Around windshear avoidance.

Figure 4-50 shows the windshear detection coverage for Airbus aircraft and aircraft that are retrofitted (Airbus and Boeing) with the WXR-2100 MultiScan radar.

Figure 4-50 Airbus/Retrofit Windshear Detection Coverage

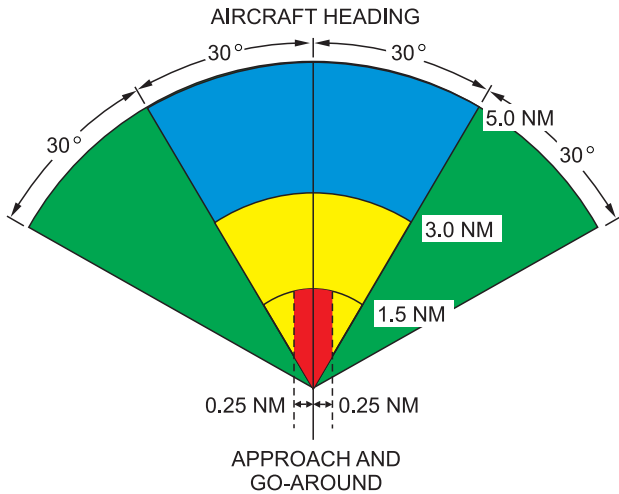

- WARNING
- CAUTION
- ADVISORY
- WEATHER DETECTION REGION (BELOW 2,300 FT.)

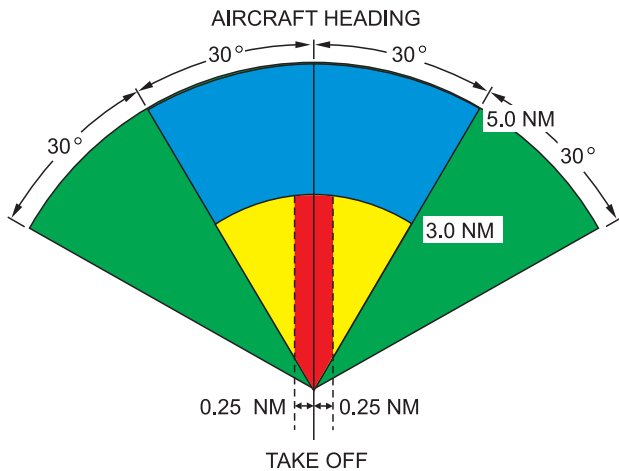

TPF9615\_52

## ***WINDSHEAR COVERAGE — BOEING AIRCRAFT***

The Boeing “safety package” integrates the Radar, TCAS and TAWS functions. When implementing the safety package, Boeing chose to eliminate all windshear advisories. Figure 4-51 shows the windshear detection region for aircraft that deliver from Boeing.

Figure 4-51 Boeing Windshear Detection Coverage

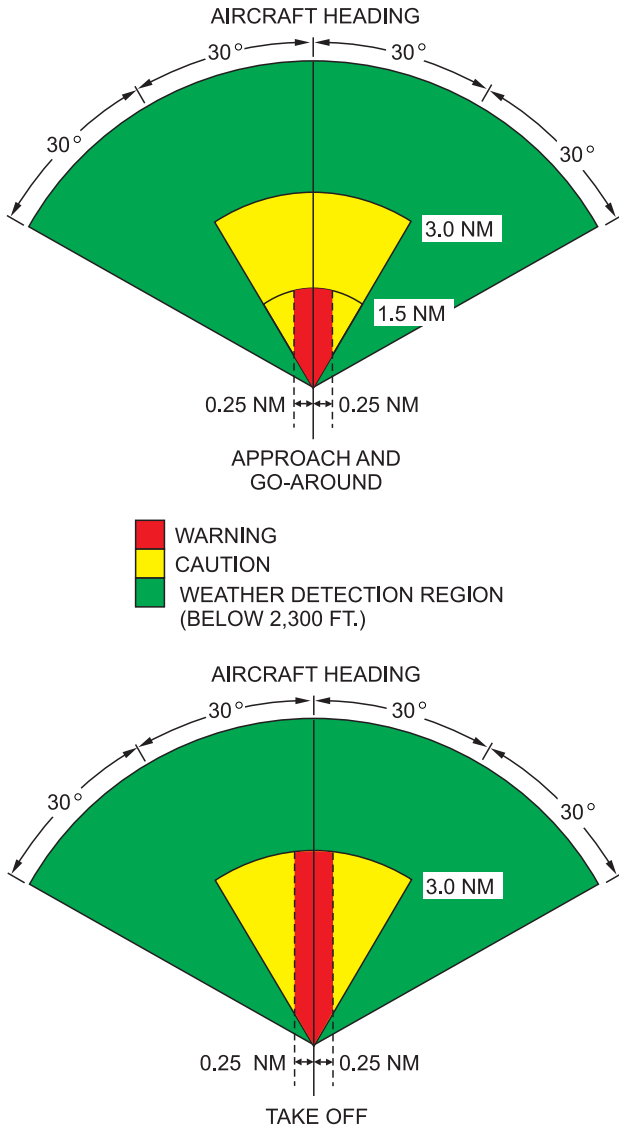

TPF9615\_53

## WINDSHEAR ALERTS

*Windshear Alert Table*

Alert Type	Aural Alert	EFIS Visual Alert	EFIS Icon Alert
Warning	“Windshear Ahead” or “Go Around, Windshear Ahead”	<b>WINDSHEAR</b> or <b>W/S AHEAD</b> or <b>WINDSHEAR AHEAD</b>	Windshear Icon* and Weather
Caution	“Monitor Radar Display”	<b>WINDSHEAR</b> or <b>W/S AHEAD</b> or <b>WINDSHEAR AHEAD</b>	Windshear Icon* and Weather
Advisory	None	None	Windshear Icon* and Weather
* Windshear Icon – Alternating red and black horizontal arches indicating the actual location of the Windshear Event (figure 4-49).			



### NOTE

If the display is turned off but the WXR-2100 has been automatically enabled and detects a windshear event, aural and visual alerts will still be operational. Radar Icons will be displayed on those aircraft that allow “pop-up” displays.

## WINDSHEAR WARNING

A windshear WARNING is generated whenever a detected windshear event occurs within  $\pm 0.25$  NM of the longitudinal axis of the aircraft and within  $\pm 30^\circ$  of the aircraft heading. When the aircraft is on the ground (takeoff roll), the windshear **WARNING** occurs for windshear events within 3 NM.

The output for a windshear warning alert consists of the following:

- A windshear icon displayed on the indicator
- A red **WINDSHEAR** warning message on the EFIS display



- An aural alert output of a voice-synthesized phrase “WINDSHEAR AHEAD, WINDSHEAR AHEAD” during takeoff, or “GO-AROUND, WINDSHEAR AHEAD” during approach (Icon, Message, Audio)

### **WINDSHEAR CAUTION**

A windshear **CAUTION** is generated whenever a detected windshear event occurs outside the windshear warning region and within  $\pm 30^\circ$  of the aircraft heading and less than 3 NM from the aircraft.

The output for a windshear caution alert consists of the following:

- The windshear icon display
- A yellow **WINDSHEAR** message on the EFIS display
- An aural alert output of a chime, or an aural alert output of a voice-synthesized phrase “MONITOR RADAR DISPLAY” (Icon, Message, Audio)

### **WINDSHEAR ADVISORY**

A windshear **ADVISORY** is generated whenever a detected windshear event occurs within an area 3 to 5 miles ahead of the aircraft and within  $\pm 30^\circ$  of the aircraft heading.

The output generated for a windshear advisory alert is a windshear icon on the display.



#### **NOTE**

Windshear advisory alerts are deactivated for all new Boeing production aircraft.



#### **NOTE**

If the display is turned off, there will be no windshear advisory alert due to the fact that there are no aural alerts associated with windshear advisories.

## PWS (PREDICTIVE WINDSHEAR) – AIRBUS ONLY

**Airbus:** The PWS switch allows the flight crew to disable automatic operation of the windshear mode by selecting the **OFF** position. The **AUTO** position allows windshear mode to function automatically during the takeoff and landing phases of flight.

Figure 4-52 Airbus PWS Control

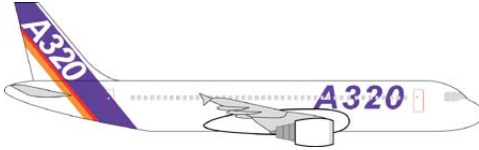
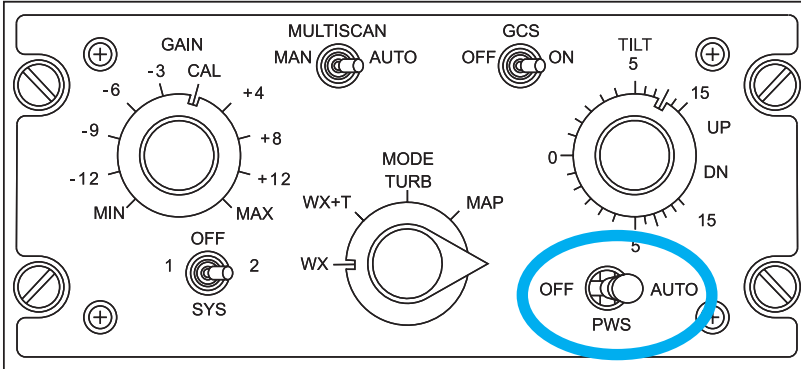

TPF9615\_21

### NOTE

A further discussion of windshear is available in the chapters AVIATION WEATHER and HOW RADAR WORKS.

## TEST

### TEST – AIRBUS AIRCRAFT

**Airbus:** System test is activated through the **CFDS** (Centralized Fault Display Unit). The **TEST** function and step by step instructions are available on the main radar menu on the **MCDU**.

## TEST – BOEING AIRCRAFT

**Boeing:** System test is activated by pressing the **TEST** button on the radar control panel. Alternately, the test procedure can be initiated through the Central Maintenance Computer (CMC) on the B747 or the Maintenance Access Terminal (MAT) on the B777 (refer to aircraft documentation for use of the CMC or MAT).

Figure 4-53 Boeing TEST Control

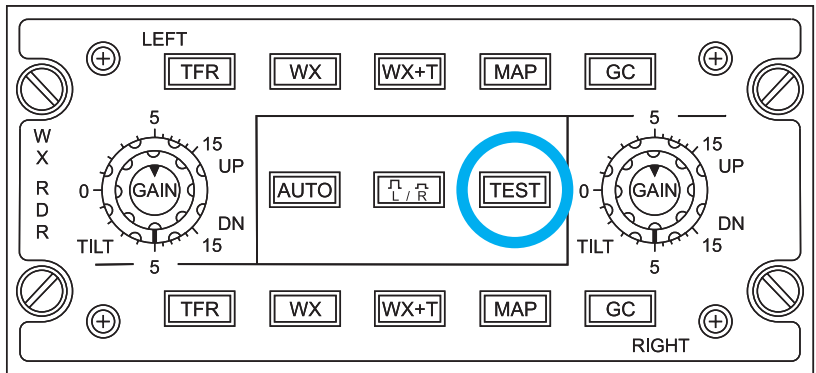

TPF9615\_45

In either case, the following test procedures should be followed:

1. Select a non-test mode on the radar control panel.
2. Select WXR to ON from the EFIS control panel.



### NOTE

If TEST mode has been previously selected on the radar control panel (i.e., Step 1 above has not been accomplished) and WXR is selected to ON from the EFIS control panel, aural warnings will be inhibited. In other words, the radar will conduct a silent self test.



## NOTE

Aural and visual windshear test annunciations are inhibited when the radar is in the automatic windshear mode (below 2,300 feet during takeoff and landing, and windshear qualifier logic has been met (♦page 6-35). When TEST is selected and the aircraft is in the automatic windshear mode, a silent self test will be performed. Only the “rainbow” self test pattern on the display will show (figure 4-54).

3. Press TEST on the radar control panel. The following should be observed when on the ground and windshear qualifier logic has not been met :

- Approximately 0-6 Seconds - The amber windshear caution light will illuminate and the aural message “MONITOR RADAR DISPLAY” will be heard.
- Approximately 6-9 Seconds - The Master Warning Light illuminates (when applicable). The windshear fail message is displayed in the flight deck.
- Approximately 9-12 Seconds - The red windshear warning light will illuminate and the aural message “GO AROUND, WINDSHEAR AHEAD, WINDSHEAR AHEAD, WINDSHEAR AHEAD” will be heard. During this time period the rainbow (with embedded windshear icon) self-test pattern (figure 4-54) will show.



## NOTE

The self-test pattern will remain displayed until the test mode is deselected.

4. If a system fault occurs, a flashing tilt code will show to indicate the system component that requires maintenance (refer to the table on page 4-56).



## NOTE

The flashing tilt code feature can be a useful tool for isolating intermittent faults during flight. If the crew notices that the windshear unavailable lamp is activated, they can select TEST and record the tilt code in order to assist ground personnel with trouble shooting.

5. If a dual R/T system is installed, conduct the test sequence for system 1 as described above. Then deselect TEST, switch to system 2 and reselect TEST. The test sequence will proceed as described above.

 **NOTE**

If system 2 is selected without first deselecting TEST, aural and visual windshear annunciations will be inhibited.

 **NOTE**

If TEST is deselected before the automatic test sequence is completed the aural message radar test terminated will be initiated.

 **NOTE**

Refer to the Component Maintenance Manual (CMM) for full details.

Figure 4-54 Boeing TEST Display

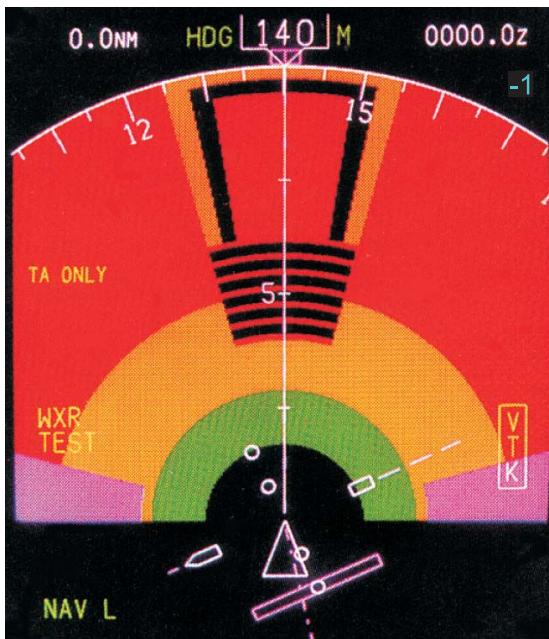

FLASHING TILT CODE  
DENOTES EXTERNAL  
SYSTEM FAULTS

TPF9615\_46

 **NOTE**

Position of the tilt code will vary for different EFIS displays.

The table below shows the tilt codes that show on the display to indicate which system component requires maintenance.

*Flashing Tilt Codes*

<b>Fault</b>	<b>Tilt Code</b>
Attitude-Left	-1
Attitude-Right	+1
Radio Altimeter-Left	-2
Radio Altimeter-Right	+2
DADC-Left	-3
DADC-Right	+3
EFIS-Left	-4
EFIS-Right	+4
WS Qualifiers	-5
Pitch/Roll	-5
Air/Ground	-7
WS Inhibit Input	-8

## ***MULTISCAN MANUAL OPERATION***

When MultiScan is operated in manual mode, the radar will function as a conventional weather radar. Tilt and gain settings, thus, become extremely important for proper weather detection and interpretation.

### ***MANUAL OPERATION: CONTROL PANEL INPUTS AND OPERATING PROCEDURES***

The following control inputs have the same function during both automatic and manual operation and are explained in the automatic operation section:

- Dual System Selection (♦page 4-18)
- PWS (Predictive Windshear) (♦page 4-52)
- TFR (Transfer) (♦page 4-20)
- WX (Weather Mode) (♦page 4-27)
- WX+T (Weather Plus Turbulence Mode) (♦page 4-28)
- TURB (Turbulence Mode) (♦page 4-31)
- MAP (♦page 4-33)
- TEST (♦page 4-52)

## MANUAL OPERATION (MAN/AUTO)

**Airbus:** Manual operation is activated for both the captain and first officer by moving the **MULTISCAN MAN/AUTO** switch to the **MAN** position (figure 4-55).

Figure 4-55 Airbus MULTISCAN MAN/AUTO Control

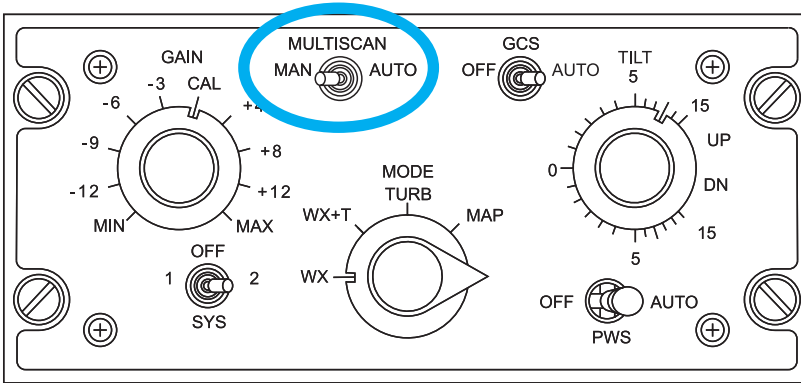

TPF9615\_93

**Boeing:** The MultiScan **AUTO** button (figure 4-56) switches between manual mode and automatic mode. The **AUTO** button is a latching alternate action switch. When the **AUTO** button is pushed in, both the Captain and the First Officer are in MultiScan automatic mode. When the **AUTO** button is in the out position, both pilots are in manual.



Figure 4-56 Boeing AUTO Control

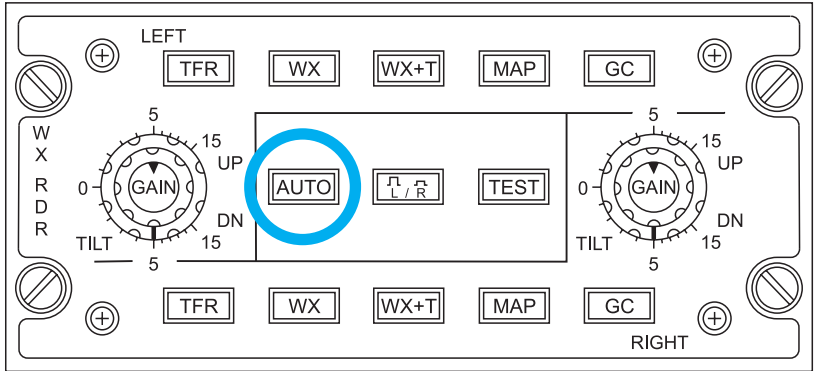

TPF9615\_18



**NOTE**

For display annunciations during manual use of the radar, refer to the Display Annunciation section on page 4-4.

### GROUND CLUTTER (INACTIVE FOR MANUAL OPERATION)

**Airbus:** The GCS switch (figure 4-57) is inactive during manual operation.

Figure 4-57 Airbus GCS Control

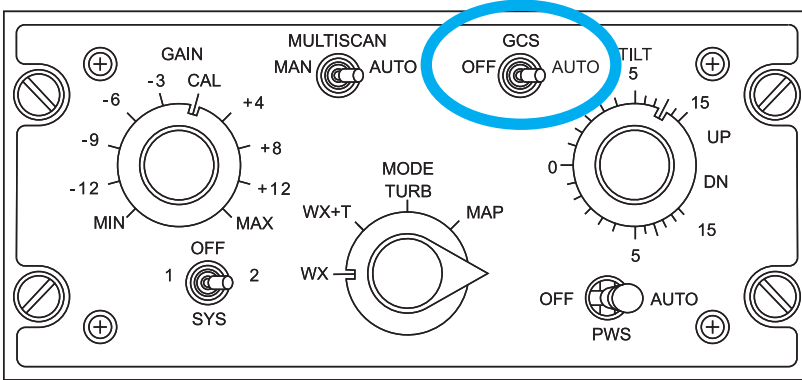

TPF9615\_29

**Boeing:** The GC button (figure 4-58) is inactive during manual operation.

Figure 4-58 Boeing GC Control

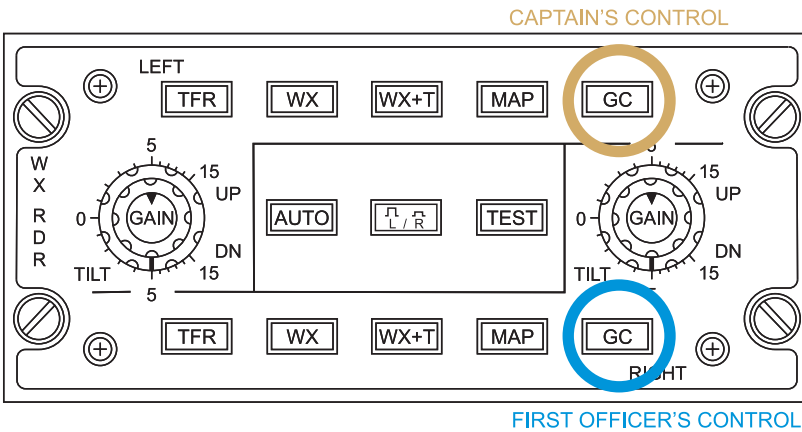

TPF9615\_30

## TILT CONTROL

The **TILT** control is active only during MANUAL operation and allows the flight crew to adjust the antenna tilt for the best display. During MultiScan AUTOMATIC operation, the **TILT** control is not active since the antenna tilt settings are managed automatically by the MultiScan function.

Tilt control is **the most important factor** for proper manual operation of the radar. In most instances, the flight crew is looking for a compromise tilt angle between too much ground return and too little weather return (figure 4-61 and ♦page 5-6). The best tilt setting will vary depending on the aircraft phase of flight (i.e., low altitude, mid altitude and high altitude). Recommended tilt settings for the various phases of flight are discussed in the scenarios that follow.

Figure 4-59 Airbus TILT Control

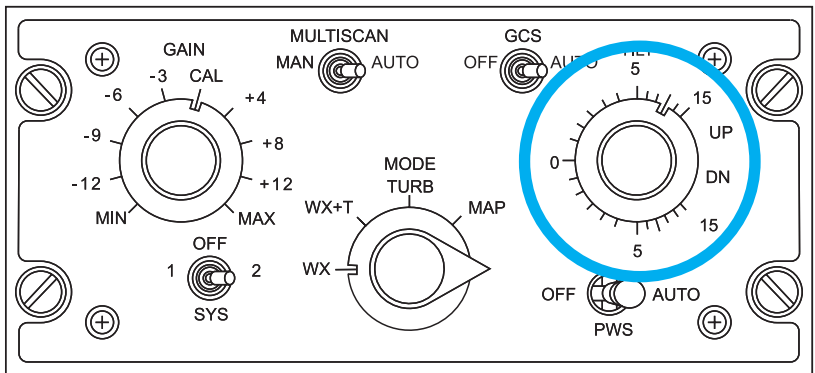

TPF9615\_27

Figure 4-60 Boeing TILT Control

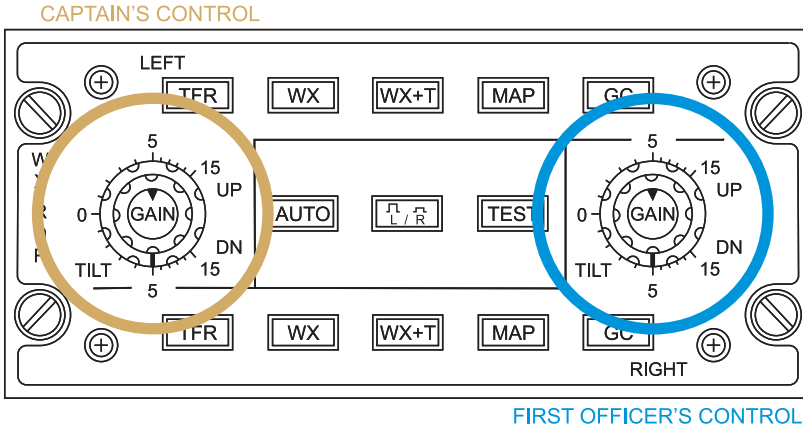

TPF9615\_28

Figure 4-61 illustrates that during manual operation, the best tilt angle is most often a compromise between a tilt angle that causes too much ground clutter and a tilt angle that detects too little weather.

Figure 4-61 Tilt Setting Compromise

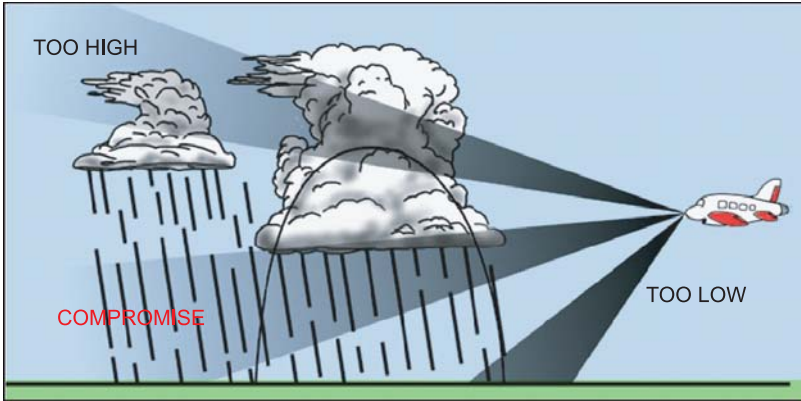

TPG3130\_15

### **LOW ALTITUDE TILT SETTINGS (10,000 FT AND BELOW)**

Below 10,000 feet, a tilt setting of between +2° and +7° is recommended with +5° being a good compromise setting. Below 10,000 feet, the flight crew is busy with a variety of tasks from completing checklists to talking with approach/departure control. Setting a +5° tilt and leaving it set through 10,000 feet reduces cockpit work load. The +5° setting will eliminate most ground clutter and detect the majority of the weather in the immediate vicinity of the aircraft (figure 4-62). The two topics that follow (Climb and Descent) explain the logic behind these guidelines, and when a +2° tilt setting and a +7° tilt setting might be appropriate.

*Figure 4-62 Recommended Tilt For Low Altitude*

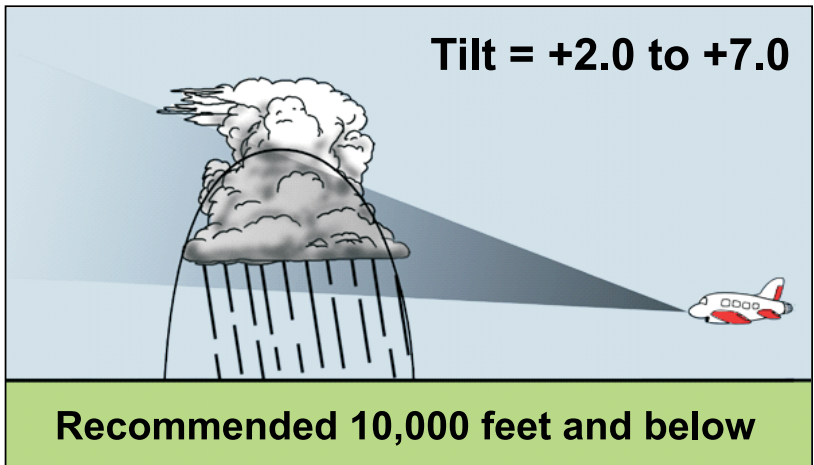

TPF9615\_57

## CLIMB

It is typical for a two engine air transport category aircraft to climb out after takeoff at approximately 240 knots with a 3000 fpm rate of climb. This equates to a  $7^\circ$  climb angle from the horizontal (figure 4-63). Therefore, a  $+7^\circ$  tilt setting keeps the radar aligned along the aircraft flight path, alerts the crew to potential penetration of vaulted thunderstorm areas (♦page 5-15) and eliminates ground clutter.

Figure 4-63 Climb Out Flight Path

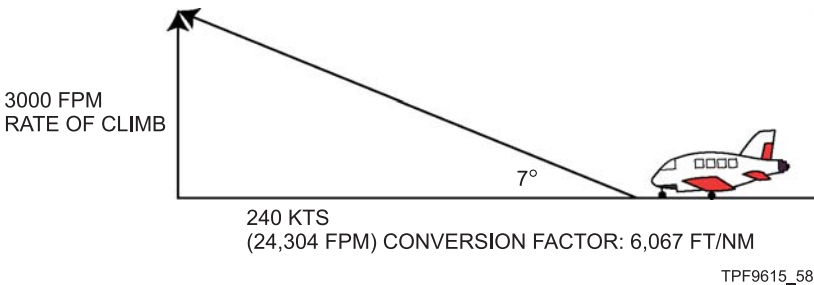

The drawback to a  $+7^\circ$  tilt is that weather detection is limited to the general vicinity of the aircraft. This can be shown using the general formula that says  $1^\circ$  of tilt gives you 100 feet per NM of beam position change. For instance, with a  $+7^\circ$  tilt the center of the beam is at 24,500 feet at 35 NM.



### TECH DETAIL

$1^\circ$  of tilt at 35 NM yields 3,500 feet of beam position change. Multiply 3,500 by 7 (due to the  $7^\circ$  of tilt). The result is the 24,500 feet used in the above paragraph.

This means that if the radar top of the thunderstorm is less than 24,500 feet, it may not be displayed on the radar. At 50 NM, the center of the beam is at 35,000 feet, and the majority of the weather at this range will not be visible due to the fact that the radar is looking at the top (♦page 5-5) of storms at this range. Since the radar beam is approximately  $3.5^\circ$  wide (♦page 6-20), a  $+5^\circ$  radar tilt angle provides a good compromise because it keeps the outer edge of the radar beam pointed close to the aircraft flight path and provides marginally better weather detection ranges.



### CAUTION

Caution: If the tilt setting is too high, the radar beam may scan above the radar tops (♦page 5-5) of thunderstorms that are a threat to the aircraft. If the tilt is too low, the radar may not detect vaulted thunderstorm energy (♦page 5-15).



### NOTE

Automatic MultiScan operation optimizes weather returns during a climb by using one beam to scan along the aircraft flight path to detect vaulted thunderstorm energy and a second beam set at a lower tilt setting to detect weather at extended ranges and prevent over-scanning of weather in the vicinity of the aircraft that is a turbulence threat. The result is that the flight crew no longer needs to compromise between tilt settings that scan weather along the aircraft flight path and settings that provide extended range weather detection and prevent over-scanning.

## DESCENT

Below 10,000 feet, a +5° tilt angle remains the best compromise for descent if cockpit work load is heavy. This tilt angle will detect most weather while at the same time eliminating the majority of ground clutter. The benefit to this method is that the tilt setting can be set and forgotten during the critical approach and landing phase of flight. However, it is possible to descend into thunderstorms that are developing below the aircraft flight path and are under the radar beam. Therefore, an alternate tilt procedure for descent below 10,000 feet is to initially set a +2° tilt setting, then gradually raise it to +5° as the aircraft descends to lower altitudes (figure 4-64).

Figure 4-64 Recommended Tilt Settings For Descent

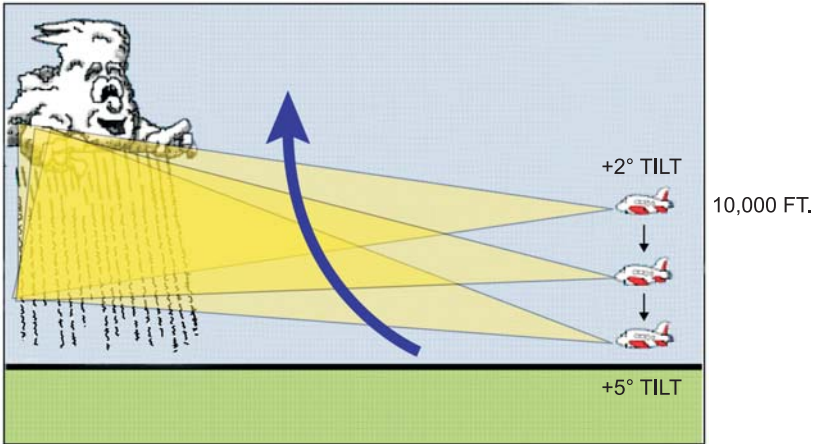

TPF9615\_59

Figure 4-65 shows the effect on the display when tilt is not raised as the aircraft descends. In the left picture, the aircraft is at 4,000 feet with +2° tilt setting. Ground clutter is just beginning to be visible on the display. In the right picture, the aircraft is at 2,000 feet with +2° tilt setting. Clutter is now able to mask weather.



Figure 4-65 Effects of Tilt Set Too Low During Descent

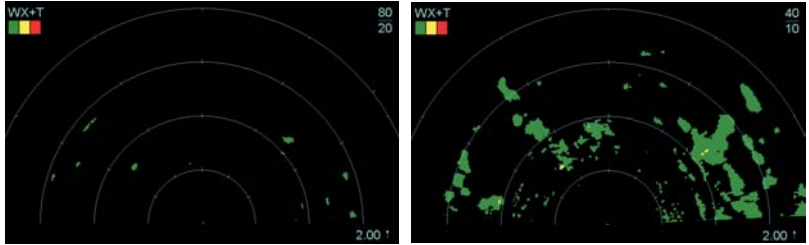

TPG3130\_16



**CAUTION**

Even with a low tilt setting of +2°, it is possible for over-scanning (♦page 4-40) to occur. Growing thunderstorms that are a threat to the aircraft may fall below the radar beam and fail to be displayed on the radar display.

If the tilt is not raised as the aircraft descends, the radar beam will progressively “dig” deeper into the ground (figure 4-66). The result is a very colorful display of ground clutter that may fully mask weather returns (figure 4-67).

In figure 4-66, the aircrew has failed to raise the radar tilt during descent. At lower altitudes the radar beam is totally immersed in the ground.

Figure 4-66 Result of Not Raising Tilt As Altitude Decreases

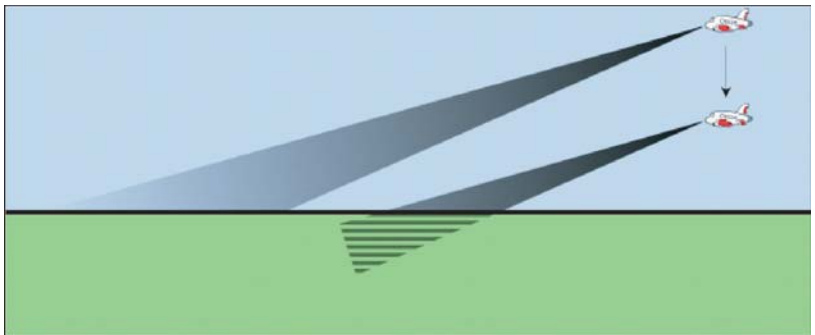

TPF9615\_60

If the radar tilt is set to display clutter at the outer edge of the 80 NM range scale at a cruise altitude of 35,000 feet and the plane then

descends to 5,000 feet without the tilt being adjusted, figure 4-67 shows the result. Ground clutter completely masks all weather returns.

Figure 4-67 Radar Display with Tilt Setting Too Low

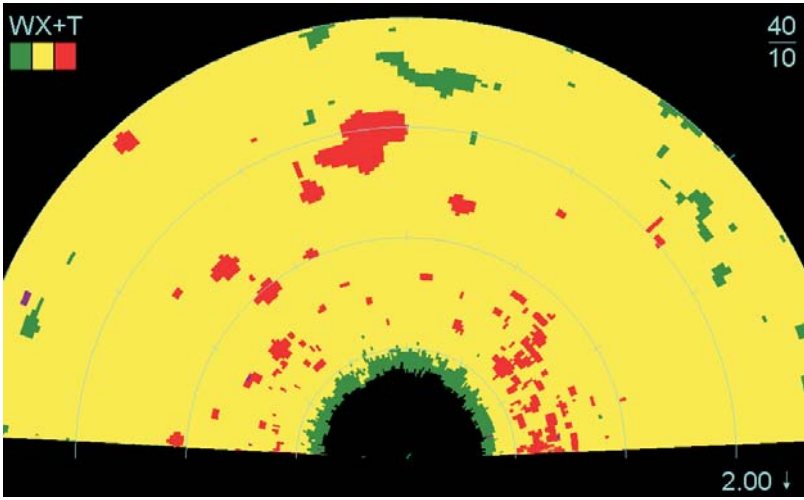

TPG3130\_17



#### NOTE

Automatic MultiScan operation optimizes weather returns during a descent by using one beam to scan ahead of the aircraft and a second beam at a tilt setting considerably lower than  $+2^\circ$  to look down the aircraft flight path. Because MultiScan is able to look down into the ground clutter, the radar can detect and protect against thunderstorms that are growing beneath the aircraft and would normally fall below the radar beam.

### **MID ALTITUDE TILT CONTROL (10,000 – 25,000 FT)**

For overland operation at mid altitudes, the best general guideline is to tilt the antenna until a small amount of ground return appears at the outer edge of the display. When operating over water ground clutter may more closely resemble the clutter in figure 4-68, regardless of which range scale is selected. Should ground clutter be insufficient for determining the appropriate tilt angle during over water flight, the table on page 4-72 provides suggested tilt angles for different altitudes.

Figure 4-68 shows the radar set to the 80 NM range scale. Antenna tilt is adjusted so that ground return is displayed in the outer most range scale. Note that this picture will look the same when the 40 NM range scale is selected and clutter is displayed in the outer most range scale.

*Figure 4-68 Radar at 80 NM, Mid Altitude*

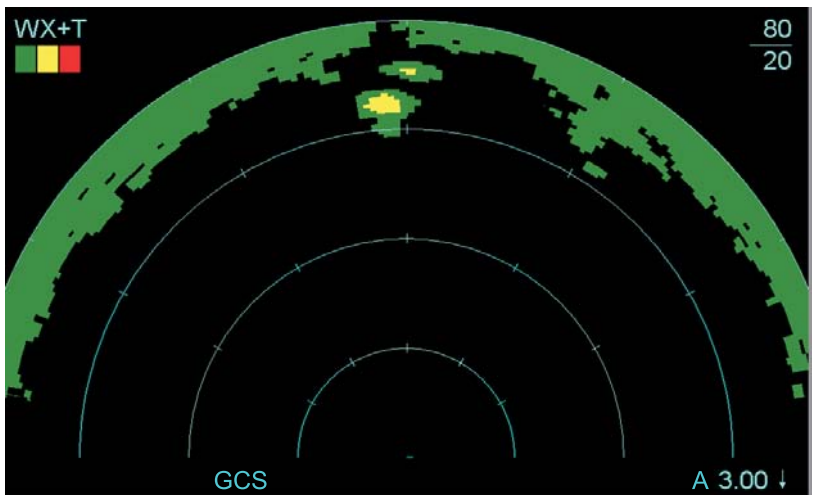

TPG3130\_18

Figure 4-69 shows the radar set to the 160 NM range scale. Antenna tilt is adjusted so that ground clutter is displayed. Note that due to the earth's curvature, it is not possible to get a clearly defined clutter ring in the outer range scale when the 160 NM range is selected.

Figure 4-69 Radar at 160 NM, Mid Altitude

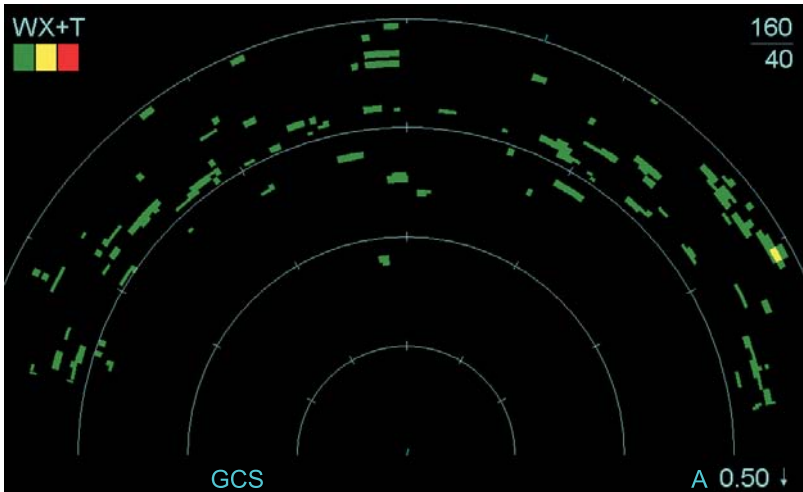

TPG3130\_19



#### NOTE

At mid altitudes, over-scanning of weather targets (♦page 4-40) begins to become a problem. This is particularly true in high northern or southern latitudes. Due to the nature of the earth's atmosphere, these regions are more likely to have high energy thunderstorm cells at lower altitudes than equivalent storm systems closer to the equator.

#### **HIGH ALTITUDE TILT CONTROL (25,000 FT AND ABOVE)**

At higher altitudes thunderstorm tops can be all but invisible to radar. When outside air temperature falls below  $-40^{\circ}\text{C}$ , thunderstorm tops are formed entirely of ice crystals and reflect very little radar energy (♦page 5-5). Significant down tilt is required to ensure that the radar beam is picking up the more reflective part of the storm that is at lower altitudes.

Over land ground clutter can be used to determine proper tilt within 160 NM of the aircraft. For longer range targets, special procedures must be used (♦page 4-79). Within 160 NM, tilting the radar so that some ground clutter appears in the outer most range scale keeps the antenna pointed towards the reflective portion of the thunderstorms that are towards the outer edge of the selected range scale (see figures 4-68 and 4-69).

Note that while over-scanning (♦page 4-40) of thunderstorms may be a problem at low and mid altitudes, the problem becomes a significant threat at high cruise altitudes. Many pilots use tilt settings based on the 80 NM range scale during high altitude cruise. However, at high altitudes this setting only optimizes weather returns between approximately 50-80 NM. Significant weather may be present in the 0-50 NM area. Over-scanning and subsequent inadvertent thunderstorm top penetration is a significant concern. Targets inside 50 NM may be over-scanned and disappear from the display but still cause significant turbulence. To view targets inside the 50 NM range, large down tilt settings are necessary. The large down tilt may prevent more distant storms from being detected, and in overland operations, will cause excessive ground clutter to appear.



#### **NOTE**

Several pilot techniques that can be used to avoid over-scanning threat weather can be found in the Over-Scan Prevention Techniques section on ♦page 4-72.



#### **WARNING**

Over-scanning and the resulting inadvertent thunderstorm top penetration is a significant threat during high altitude operations.



#### **NOTE**

MultiScan's lower beam is adjusted to hold significant weather in the radar beam far longer than conventional radars. In addition, OverFlight™ protection incorporates a memory feature to ensure that any thunderstorm that is a threat to the aircraft will remain on the display until it passes behind the aircraft.

## **RECOMMENDED TILT SETTINGS FOR OVER WATER OPERATION**

The table below provides recommended tilt settings for aircraft operating over water when ground clutter is not available to help determine the optimum tilt angle. The recommended tilt settings place the lower part of the antenna beam at the edge of the outer range scale.

### *Recommended Over Water Tilt Settings*

<b>Altitude (feet)</b>	<b>40 NM</b>	<b>80 NM</b>	<b>160 NM</b>
40,000	-7°	-3°	-2°
35,000	-6°	-2°	-1°
30,000	-4°	-1°	0°
25,000	-3°	-1°	0°
20,000	-2°	0°	+1°



### **NOTE**

Lower tilt settings may be required due to the non-reflective nature of oceanic weather (♦page 5-16).

## **OVER-SCAN PREVENTION – PILOT TECHNIQUES**

**Method 1:** One pilot technique that is used to judge which storms are a threat and which are not when using the 80 NM range scale is to use the 40 NM range (the mid point on the display) for a decision point criteria. If the storm stays in the radar beam (i.e., is painted on the display) through 40 NM, then it should be considered a potential threat and avoided. Thus, a storm cell that disappeared from the display at 40 NM is still a potential threat. The position should be tracked mentally and avoided.

**Method 2:** For aircraft equipped with a split function control panel (♦page 4-2), another technique can be used to reduce the threat of over-scanning significant weather. In this case one pilot should utilize the 80 NM range scale (or higher) with a tilt setting that places ground clutter in the outer most range scale while the second pilot utilizes a 40 NM range (or less) with an increased down tilt that places clutter in the outer range scale of the 40 NM display. Use suggested mid and high altitude tilt settings over water when ground return is not present.

The 80 NM range is then available to help plan any required course changes and the shorter range can be used to prevent over-scanning and inadvertent thunderstorm top penetration.

The left picture shows the radar display with the aircraft at 35,000 feet with 40 NM range selected. The picture on the right shows the radar display at the same altitude, but with 80 NM range selected. Note the cell directly in the aircraft path that has disappeared from the 80 NM range scale.

*Figure 4-70 Radar Displays Using Split Function*

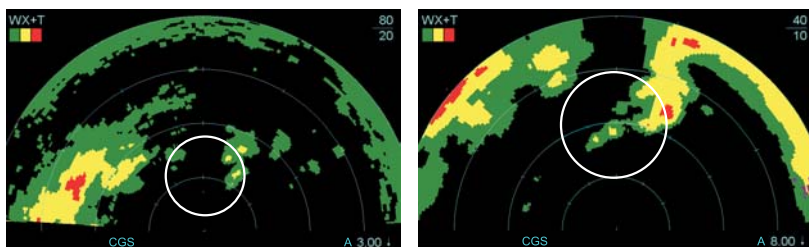

TPG3130\_20

**Method 3:** The threat of over-scanning can be reduced by periodically selecting the 40 NM range scale and adjusting the tilt so that some clutter appears in the outer most range scale. Observe potential target threats in this region. Then switch to the 80 NM range scale and adjust the tilt upwards until ground clutter is once again in the outer range scale only. Continue adjusting the range and tilt until the desired range scale is in use. Repeat the procedure periodically or when the location of thunderstorms within 40 NM of the aircraft needs to be determined.

**Method 4:** Another way to detect possible impending turbulence is through using a combination of **MAX** gain and tilt control. Setting the tilt to zero and the gain to **MAX** may allow the radar to see the ice crystals that compose the top of the thunderstorms (figure 4-71). If ANY weather is detected in front of the aircraft, then adjust the tilt downward to see if the weather return grows in intensity (figure 4-72). If it does, you can be fairly sure that you are approaching the glaciated (composed of ice crystals) top of a thunderstorm cell.

Figure 4-71 shows the aircraft at 39,000 feet with tilt set to zero degrees. Gain is set to **MAX**. A minimal weather return shows at 25 NM.

Figure 4-71 TILT Set to Zero, GAIN Set to MAX: Minimal Weather Return

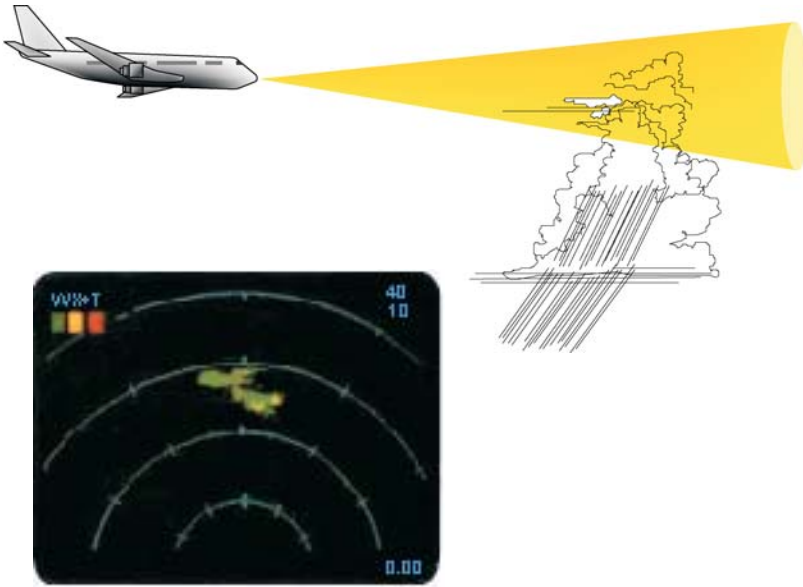

TPF9615\_61

Figure 4-72 shows the aircraft at 39,000 feet with tilt set to  $-7^{\circ}$  and gain set to **MAX**. A strong weather return at 25 NM indicates significant convective activity that more than likely will cause turbulence when the aircraft passes this point.



*Figure 4-72 TILT Set to  $-7^{\circ}$ , GAIN Set to MAX: Strong Weather Return*

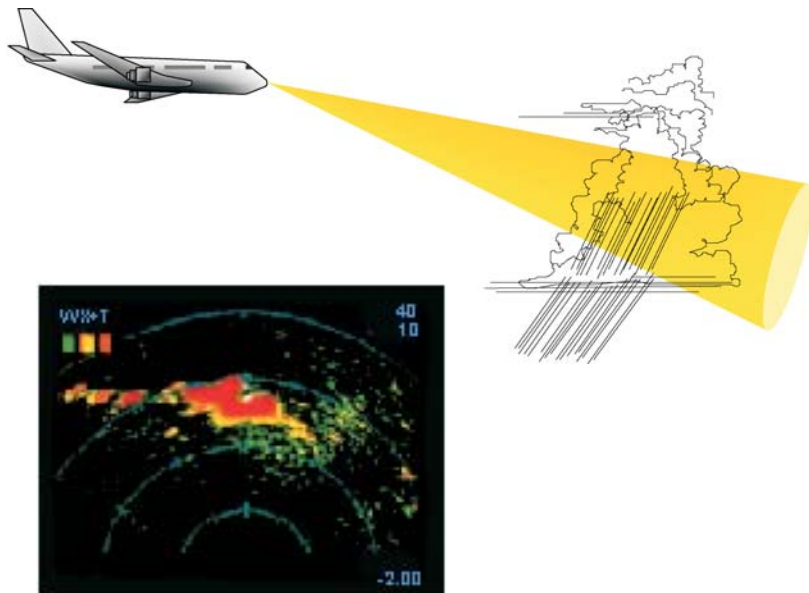

TPF9615\_62

Due to the fact that the beam diameter increases with range (♦page 6-20), this method is most accurate when the storm cell is within 40 NM of the aircraft. Once weather is detected with the  $0^{\circ}$  tilt setting, significant down tilt will be required to look below the aircraft flight path to investigate for thunderstorm activity.

**CAUTION**

Method four can give indications of possible turbulence in the aircraft flight path but should be used **in conjunction with** methods 1, 2 or 3 in order to prevent missing significant weather that is below the radar beam but still a turbulence threat.

**STORM HEIGHT ESTIMATION (RADAR TOP ONLY)**

**WARNING**

Although the following formula is valid for estimating the wet tops of storm cells within 100 miles, pilots should be aware that the weather radar will not “paint” frozen dry top precipitation such as snow or hail (due to low reflectivity). These low reflectivity targets are frequently accompanied by severe turbulence. This fact should be taken into account – for this reason it is not recommended that pilots attempt to overfly or underfly storm cells.

The height of the radar top or wet top (♦page 5-5) of a thunderstorm can be estimated by raising the tilt until the storm disappears from the radar display (figure 4-73). Height is then equal to the aircraft altitude + (antenna tilt x distance x 100).

**WARNING**

The top of the precipitation activity is not necessarily the top of the danger area. Dangerous turbulence frequently exists at altitudes significantly above the altitude at which detectable precipitation is formed.

In figure 4-74, the tilt is raised until the storm cell has all but disappeared when 2° up tilt has been selected. The cell is 25 NM in front of the aircraft and the aircraft is at 30,000 feet. Therefore, the estimated height of the wet top of the storm is at 3,500 feet. Remember that significant vertical thunderstorm development and associated turbulence may exist above the wet top of a thunderstorm.

*Figure 4-73 Using Tilt to Estimate Radar Top of Thunderstorm*

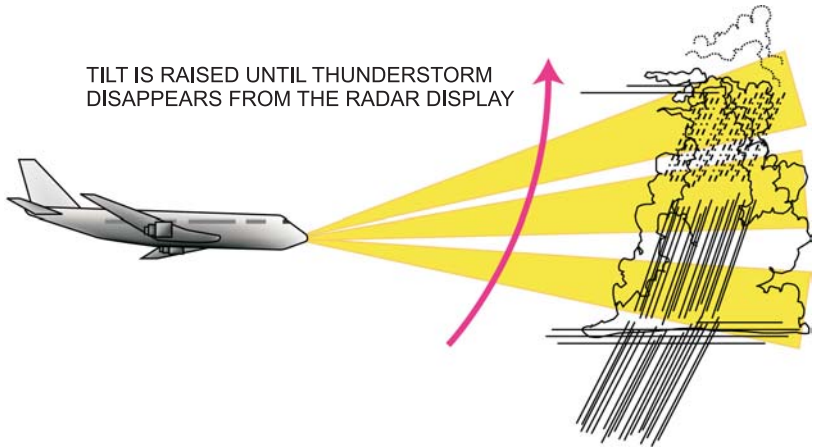

TPG3130\_21

Figure 4-74 Radar Display of Storm Top

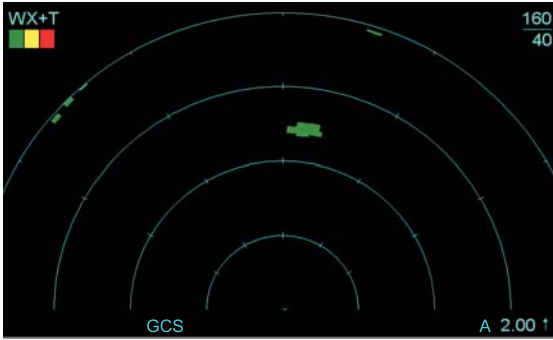

TILT RAISED UNTIL TOP OF STORM DISAPPEARS.

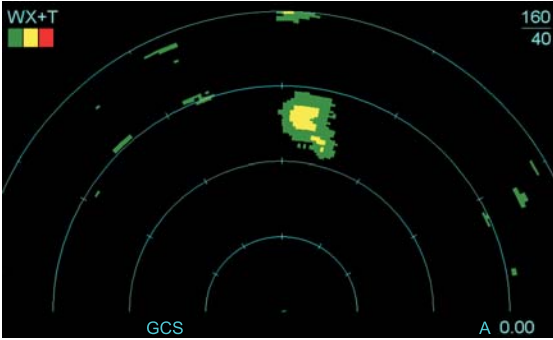

TILT RAISED TO ELIMINATE CLUTTER AND SHOW CELL.

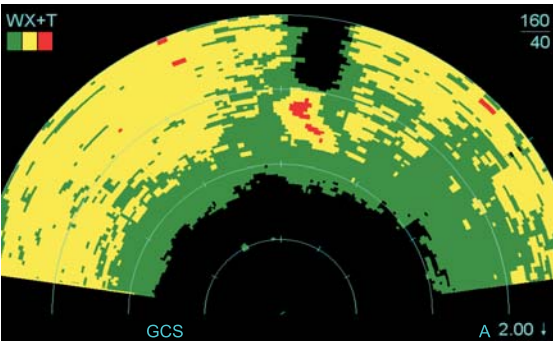

INITIAL TILT SETTING. CELL IS BURIED IN GROUND CLUTTER.

TPG3130\_22



**CAUTION**

Significant vertical thunderstorm development and corresponding severe turbulence may exist above the radar/wet top of a thunderstorm (♦page 5-5).

**LONG RANGE (OVER THE HORIZON) WEATHER DETECTION**

The ability to gather strategic weather information out to 320 NM is possible if proper tilt procedures are utilized. First one must realize that over a distance of 320 NM the curvature of the earth causes the earth's surface to fall away by approximately 65,000 feet. Thus, if the aircraft is at 25,000 feet at its current position, the earth's surface is actually 90,000 feet below the aircraft at 320 NM distance. If common practice is followed and the tilt is adjusted to eliminate the majority of ground clutter, the radar beam will scan over the top of long range weather and distant thunderstorms will remain undetected (see figure 4-75).

The radar horizon is the point where earth's surface has dropped below the radar beam and ground return is no longer displayed.

*Figure 4-75 TILT Set To Scan Radar Horizon*

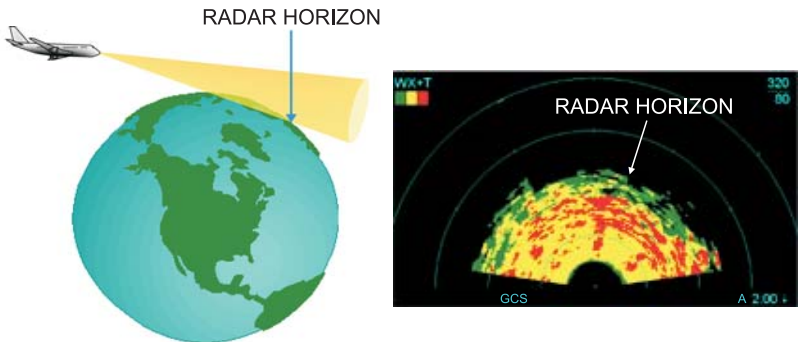

TPF9615\_65

If common practice is followed and the tilt is adjusted to eliminate the majority of ground clutter, the radar beam will scan over the top of long range weather (see figure 4-76). In most cases, eliminating ground clutter from the radar display limits weather detection to between 120 and 140 NM.

Figure 4-76 Long Range Scan With Minimal Down Tilt

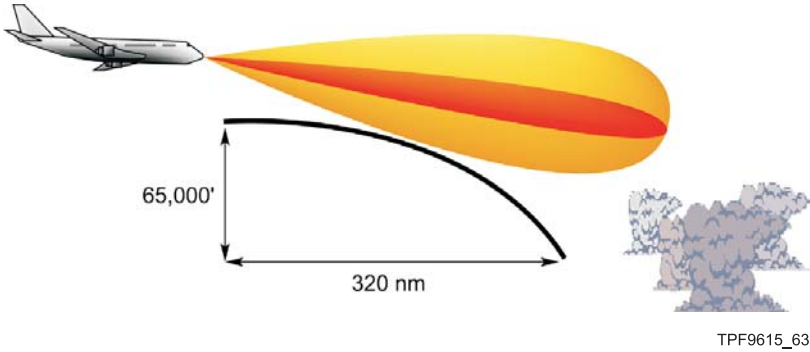

To detect long range weather, the radar beam should be adjusted so that it “peeks” over the radar horizon. Adjusting the tilt so that the radar beam is centered on the horizon directs the center of the beam towards the threat weather and allows long range weather to be displayed (see figure 4-77).

Figure 4-77 Long Range Scan With Increased Down Tilt

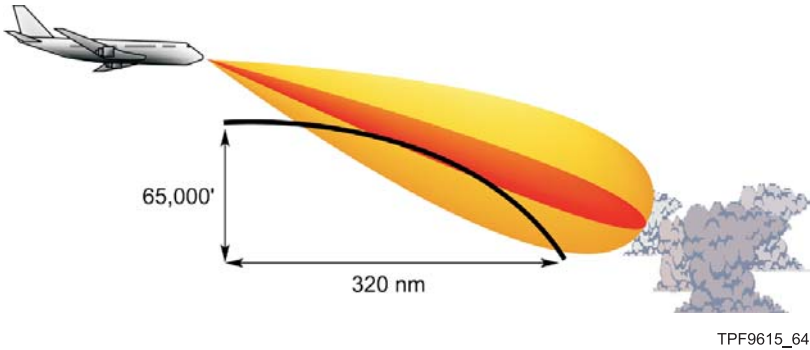

One technique that can be used for long range weather detection is to adjust the tilt downwards until ground clutter first begins to appear at the radar horizon. Then adjust the beam an additional 2° down. This will position the center of the beam near the radar horizon. If you are over water and ground clutter is not present, the approximate tilt angle to center the beam on the radar horizon can be calculated using the following formula:  
Angle to the horizon = - 0.0167 times the square root of the altitude.

*Tilt Angle to Horizon Settings*

Altitude (feet)	Angle to Horizon
44,000	- 3.50°
38,000	- 3.25°
32,000	- 3.00°
27,000	- 2.75°
22,000	- 2.50°
18,000	- 2.25°

Figure 4-78 shows the end result. The aircraft is at 23,000 feet. A down tilt of -2° has been selected by the pilot. Intermediate weather is masked by the ground, but long range strategic weather is now clearly visible at 300 NM. The radar horizon is at 186 mile (see formula above for calculations). Ground clutter is not displayed beyond this point.

*Figure 4-78 Weather Return Visible At Edge of Radar Horizon*

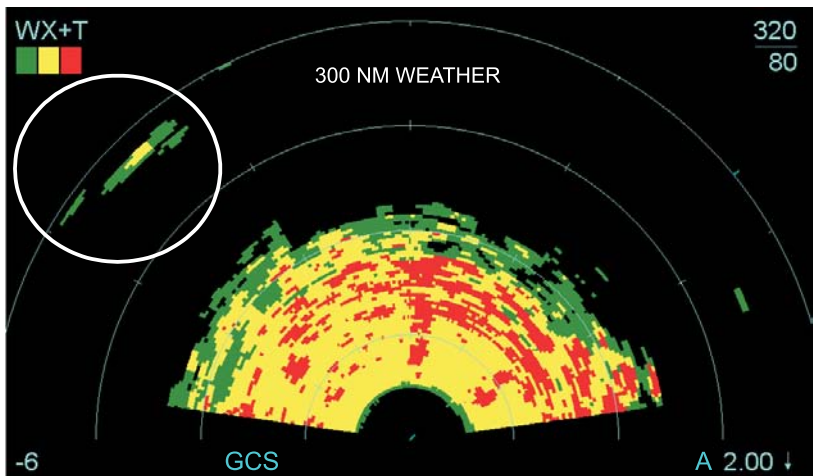

TPF9615\_66



## NOTE

Automatic MultiScan operation uses a low beam that skims the radar horizon to detect long range weather. Ground returns are eliminated using Collins' patented ground clutter suppression algorithms. The result is optimized long range weather detection from mid and high altitudes without compromising short and intermediate range weather detection (♦page 4-22).

## GAIN

The WXR-2100 MultiScan radar allows the flight crew to select full above and below **CAL** gain control in all modes (automatic and manual). The **CAL** gain position sets the radar sensitivity to the standard calibrated reflectivity levels (♦page 6-4) and is the recommended position for normal operations.

During low altitude operations where thunderstorm energy is easily reflected, gain can be momentarily decreased to determine areas of greatest thunderstorm intensity. During high altitude operations where thunderstorms exhibit minimal reflectivity, gain can be increased to better reflect thunderstorm tops.



## NOTE

For information on gain controls and additional operating techniques see the sections Gain *PLUS*™ (♦page 4-35) and Gain (♦page 6-4).

## THE TOTAL WEATHER PICTURE

In general, an experienced pilot mentally assembles the total weather picture by combining weather pictures taken at various tilt angles and with different gain settings. Scanning with various tilt angles allows the pilot to see weather at different ranges and varying the gain increases or decreases receiver sensitivity to best respond to the reflective nature of thunderstorms at the aircraft's altitude.





**NOTE**

MultiScan works exactly like an experienced pilot operates the radar. Multiple scans are taken at different tilt angles in order to view weather at different ranges. Gain is varied automatically to compensate for areas of lesser and higher reflectivity. The total weather picture is then assembled inside the computer, ground clutter is removed, and the information is delivered to the flight crew's displays. The end result is an optimum weather picture from the nose of the aircraft out to 320 NM (♦page 4-22).

This page intentionally left blank

## **TABLE OF CONTENTS**

Title	Page
Reflectivity .....	5-1
The Water Molecule and Reflectivity .....	5-1
Bright Band .....	5-4
Thunderstorm Reflectivity .....	5-5
Thunderstorms .....	5-8
Introduction .....	5-8
Single-Cell Thunderstorm Development .....	5-8
Multi-Cell Thunderstorms .....	5-11
Steady-State Thunderstorms .....	5-13
Thunderstorm Characteristics .....	5-14
Squall Lines .....	5-20
Microbursts And Windshear .....	5-22
Microbursts .....	5-22
Windshear .....	5-26
Hazardous Weather .....	5-31
Introduction .....	5-31
Steep Gradient .....	5-33
Scalloped Edges, Pendant, Finger, Hook, U-Shape .....	5-34
Non-Reflective Weather .....	5-37

This page intentionally left blank

# AVIATION WEATHER

## REFLECTIVITY

### THE WATER MOLECULE AND REFLECTIVITY

A water molecule is composed of two hydrogen atoms with positive polarity and one oxygen atom with negative polarity. Thus, the side of the molecule where the hydrogen atoms are attached is positive while the opposite side of the molecule is negative. This is referred to as a bipolar (having two poles) condition (see figure 5-1).

Figure 5-1 Basic Water Molecule

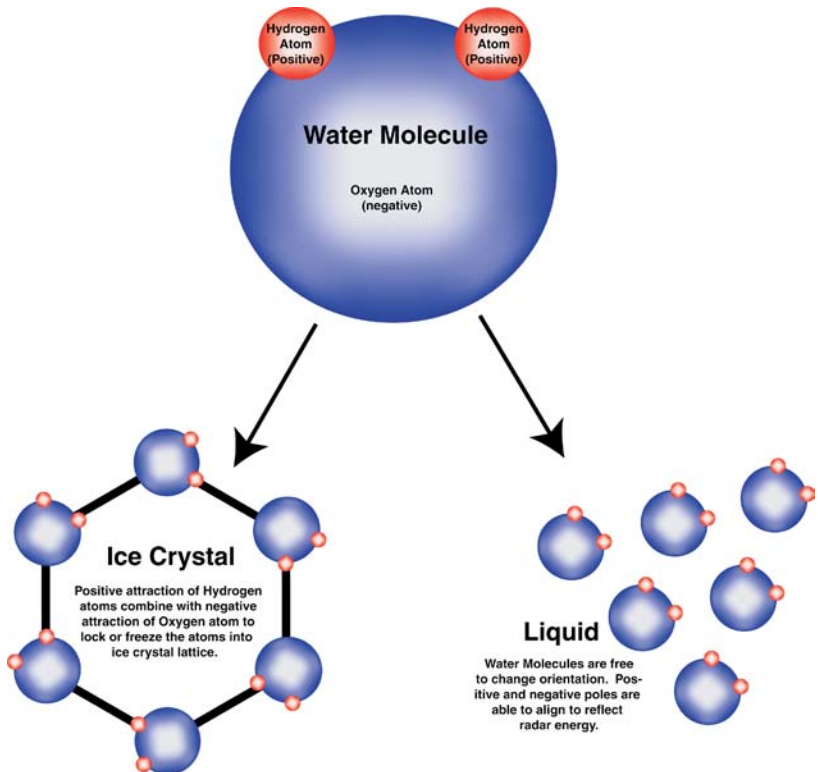

TPG3130\_27

Ice crystals are formed when the positive hydrogen atoms and the negative oxygen atom of individual water molecules lock or freeze the molecules into an ice crystal lattice. The molecules contained in the ice crystal are unable to change orientation to respond to and reflect radar energy and are thus extremely difficult for radar to detect.

When water molecules are in a liquid state they are attracted to each other but are still free to move and rotate to some degree. Thus, when radar energy hits these molecules, the poles of the molecule are able to align and reflect significant amounts of radar energy.

An airborne radar's pulse energy is optimized to detect water. The radiated radar energy reflects best when the bipolar (positive and negative) water molecules are able to align. When water freezes, the water molecules are locked into an ice crystal lattice and are unable to align to reflect radar energy efficiently. The same concepts are involved in microwave cooking where water boils very quickly but frozen foods take a great deal of time to thaw.

The end result is that ice crystals reflect very little radar energy while water (rain) is an excellent radar reflector. Figure 5–2 shows different kinds of precipitation and their ability to reflect radar energy.

Figure 5-2 Reflectivity Characteristics of Precipitation

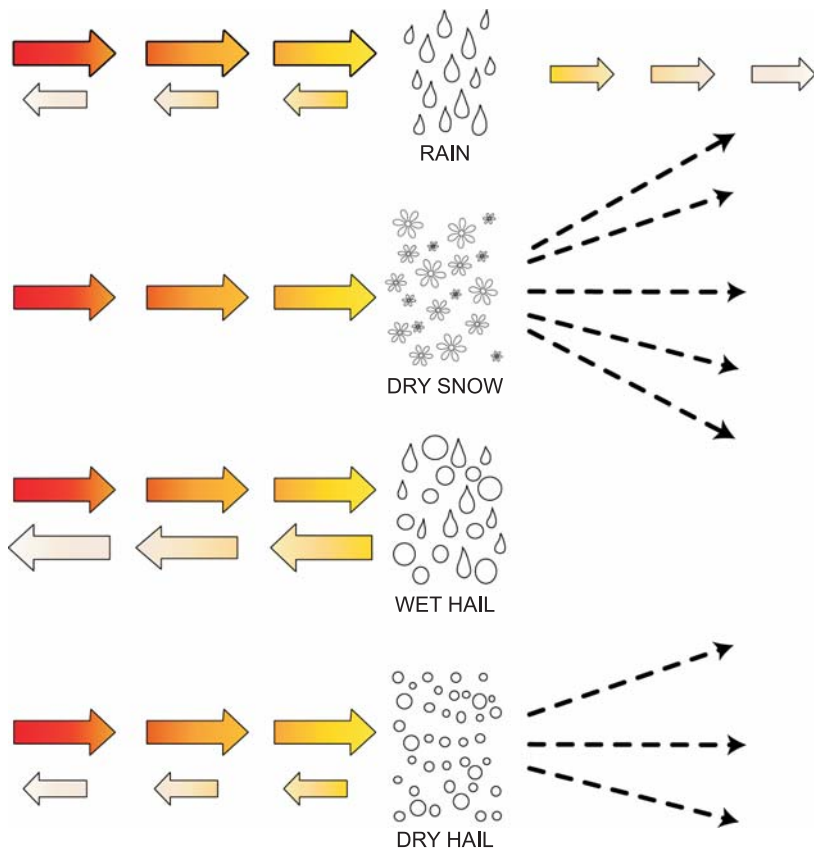

TPF9615\_69

Airborne weather radar has been optimized to detect rain. Rain drops act as an excellent reflector for the radar's microwave energy. Under most circumstances, some radar energy will also penetrate rain targets in order to detect weather that lies behind the initial target.

Dry snow and ice crystals are very poor reflectors of radar energy. The ice crystal's lattice structure prevents the bipolar water molecules from aligning to reflect radar energy.

Wet hail provides the strongest reflection of radar energy. The size of the target (hail) combined with the ability of the bipolar water molecules on its surface to align to reflect radar energy ensures maximum reflectivity

levels. In many cases radar energy is unable to penetrate beyond this type of target and weather behind the initial target is masked (hidden).

Dry hail reflects some radar energy simply due to its size. However, the crystal structure of the dry hail will fail to reflect significant amounts of radar energy. This situation can cause the radar to underestimate an area of severe weather.

## ***BRIGHT BAND***

“Bright Band” is associated with stratiform rain and occurs at or within 3,000 feet below the freezing level. In this region, ice crystals begin to melt and are coated with a layer of water. Similar to the wet hail described above (but on a smaller scale), this results in very strong radar returns. If the radar beam is directed into this region it may cause the entire weather picture to turn red (red out) due to the fact that the stratiform rain clouds may cover a large geographical region.



### **NOTE**

If the aircraft encounters stratiform rain conditions and red out occurs at or near the freezing level, changing the tilt so that the radar beam is either above or below the area of bright band may improve the radar picture. In addition, turning the gain below the **CAL** (calibrated) position should allow the flight crew to detect any “hot spots” or areas of severe precipitation.



## **THUNDERSTORM REFLECTIVITY**

A thunderstorm is composed of three parts, each with different weather radar reflectivity characteristics as shown in figure 5-3.

*Figure 5-3 Anatomy of Thunderstorm Weather Radar Reflectivity*

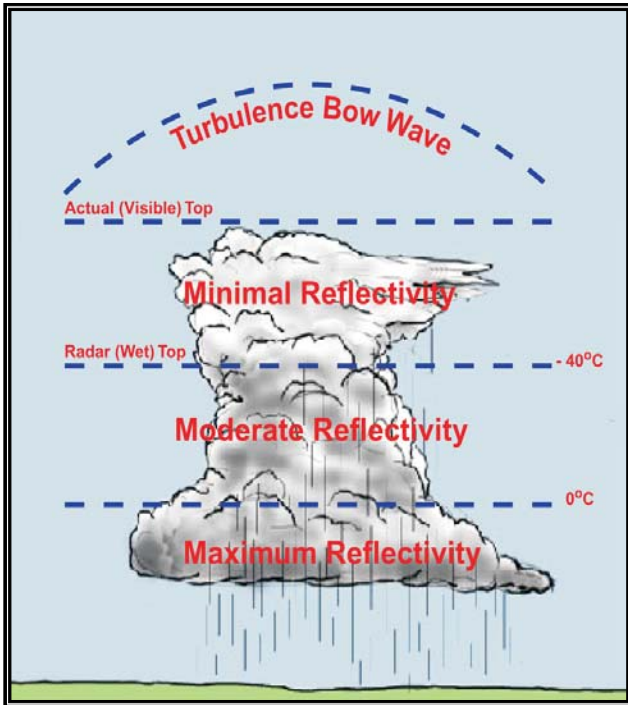

TPF9615\_03

The bottom portion of the storm, below the freezing level, is composed entirely of liquid precipitation (i.e., rain) and is the most reflective portion of the storm. Raindrops serve as excellent reflective surfaces for the 10,000 MHz radar energy produced by today's X-band airborne weather radars.

The middle portion of a thunderstorm occurs above the freezing level ( $0^{\circ}\text{C}$ ) and up to the altitude where the outside air temperature drops below  $-40^{\circ}\text{C}$ . This section of the storm is composed of a combination of ice crystals and supercooled water. The supercooled water provides moderate reflectivity, but some reflective energy will be lost due to the presence of the ice crystals. The top of this section of the storm is often

referred to as the wet top or radar top of the thunderstorm because the radar detects very little of the thunderstorm above this point.



### WARNING

Significant vertical thunderstorm development with severe turbulence and dry hail may exist above the radar top.

The top of a thunderstorm is composed entirely of ice crystals and reflects very little radar energy. At temperatures less than  $-40^{\circ}\text{C}$ , liquid water no longer exists and only ice crystals are present. The altitude at which this temperature occurs varies depending on the time of day, time of year and is based on latitude and longitude. The top of this section of the storm is referred to as the **actual** or **visible** top.

Thunderstorms can grow as rapidly as 6,000 feet per minute. Building thunderstorms have a turbulence bow wave that may extend several thousand feet above the visible top of the storm. The bow wave may cause severe turbulence but is completely invisible to radar.

It is important to note that significant turbulence may exist well above the radar top of the thunderstorm. Serious injury and even death have occurred due to inadvertent penetration of thunderstorm tops or the turbulence bow wave that radar failed to detect.

Figure 5-4 shows an observed thunderstorm and the corresponding radar displays at six different tilt angle settings. Note the change in the weather and ground clutter reflectivity as the radar beam moves up and down in the thunderstorm.



### NOTE

For the particular thunderstorm cell shown in figure 5-4, the best weather detection occurs with a  $2^{\circ}$  down tilt. The best tilt for eliminating ground clutter is  $1^{\circ}$  up. When operating in the manual mode, finding the right tilt angle often requires a compromise between too much ground clutter and too little weather.

Figure 5-4 Thunderstorm Radar Displays versus Tilt Angle



3° DOWN TILT

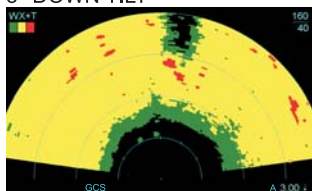

1° UP TILT



2° DOWN TILT

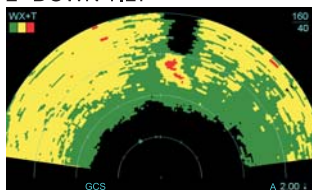

2° UP TILT



1° DOWN TILT

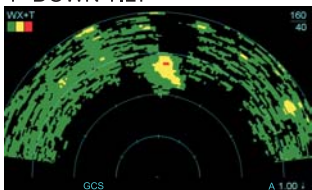

3° UP TILT

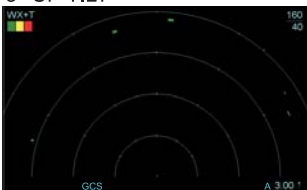

0° TILT

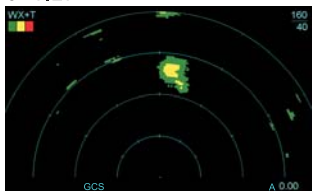

TPG3130\_28

# **THUNDERSTORMS**

## **INTRODUCTION**

Thunderstorm development requires warm, humid, unstable air (warm air near the surface and cooler air at higher altitudes). These conditions are most common during the spring and summer months. In addition, some type of lifting mechanism must be available to move the warm moist air upward. This lifting motion might be provided by frontal systems, air moving over mountains or even from gusts that originate in other thunderstorms.

*Figure 5-5 Severe Thunderstorm Activity*



TPG3130\_29

## **SINGLE-CELL THUNDERSTORM DEVELOPMENT**

Single-cell thunderstorms are relatively rare but they do provide the building blocks for more complex thunderstorm systems. Single-cell thunderstorm development is described in figures 5-6 through 5-8. Note that the entire life cycle from the time that the thunderstorm begins to form until it dissipates is approximately one hour. Thus, these thunderstorms are very dynamic, so rapid changes in associated

weather conditions should be anticipated. When examining weather at longer ranges, anticipate changes to the observed weather as the aircraft approaches the thunderstorm location.

### **TOWERING CUMULUS STAGE**

During the first stage of thunderstorm development, warm humid air rises from the ground, creating an updraft. When this rising warm air cools to the dew point, the air becomes saturated and is unable to hold additional water vapor. Condensation occurs at this point and a cloud begins to form (figure 5-6.)

*Figure 5-6 Thunderstorm — Towering Cumulus Stage*

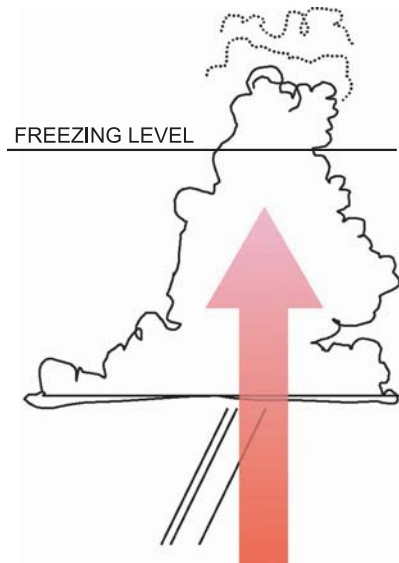

TPG3130\_30

### **MATURE STAGE**

As the warm humid air continues to rise well above the freezing level, the water becomes supercooled and ice crystals are formed. The moisture that is held aloft by the strong updrafts forms an area of potential energy know as thunderstorm vaulting (♦page 5-15). When the water droplets and ice crystals grow large enough to overcome the updraft, they begin to fall. This falling moisture will start dragging down

the surrounding air, creating a downdraft. Eventually, this downdraft is occurring simultaneously with the updraft. The existence of both updrafts and downdrafts in a mature thunderstorm creates severe turbulence (figure 5-7).

*Figure 5-7 Thunderstorm — Mature Stage*

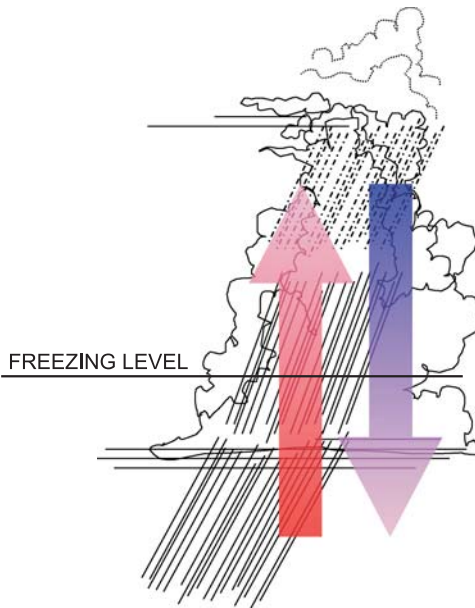

TPG3130\_31

### ***DISSIPATING STAGE***

During the dissipating stage of the storm, the downdraft eventually becomes so large that it chokes off the supply of warm humid air that is rising from the surface. When this occurs, the storm begins to die and the rain decreases (figure 5-8).

Figure 5-8 Thunderstorm — Dissipating Stage

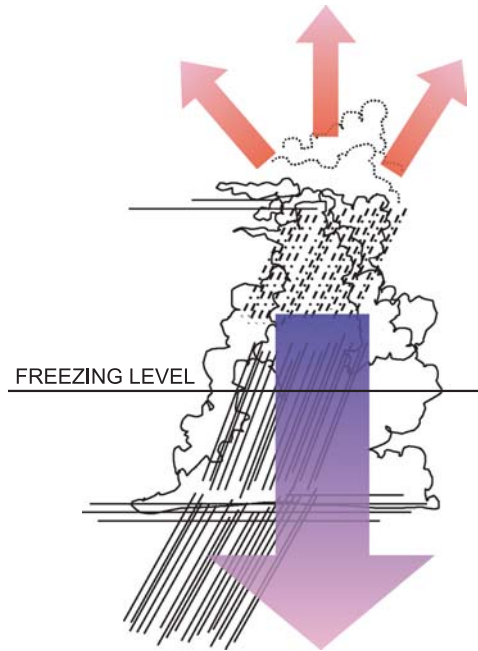

TPG3130\_31

## **MULTI-CELL THUNDERSTORMS**

Most thunderstorms are actually multi-cell storms. That is, they are composed of several cells in various stages of development. The downdrafts from mature or decaying thunderstorm cells create a gust front (a blast of cooler air along the ground) that can provide the necessary lifting mechanism to cause new cells to develop (figure 5-9).

Multi-cell thunderstorms have the same kind of volatility as single-cell storms and rapid change should be anticipated.

**CAUTION**

Developing cells may not contain enough moisture to reflect radar energy, but still contain severe turbulence. Whenever possible, deviate to the upwind side of storms displayed on the radar.

Figure 5-9 Multi-Cell Thunderstorm

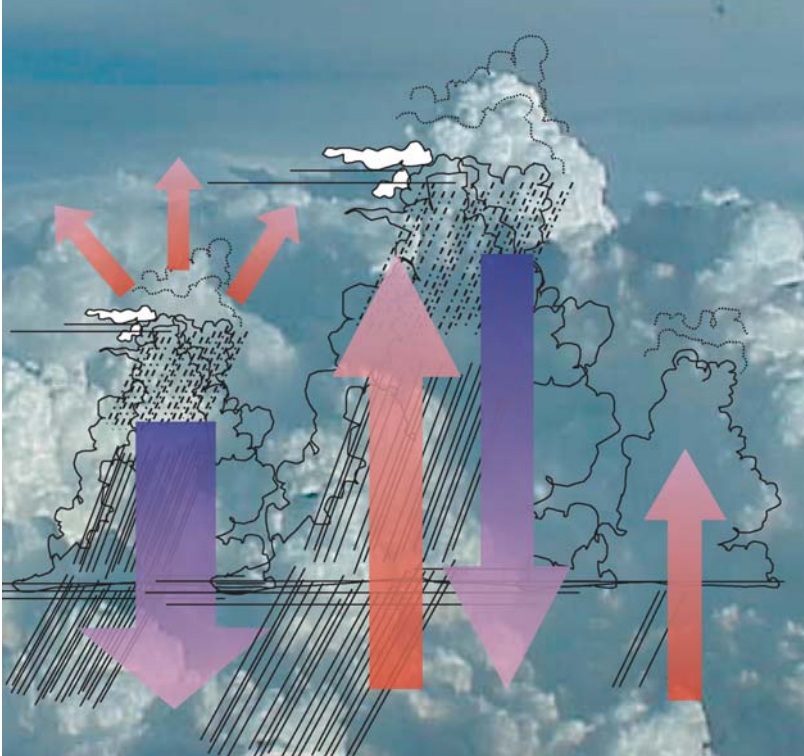

TPG3130\_33

**NOTE**

Studies have shown that thunderstorms tend to travel in the direction of the winds around the 10,000 feet level.

**NOTE**

In a multi-cell thunderstorm environment, new cells will tend to form to the downwind side of the existing thunderstorm system.





**NOTE**

Multi-cell thunderstorms have a normal life span of 3-4 hours.

**STEADY-STATE THUNDERSTORMS**

Steady-state thunderstorms do not follow the normal one-hour growth and decay cycle for a typical thunderstorm. As the name implies, the environmental factors that create these type of storms can give them a long active life, from 6 to 8 hours. These storms can be 5 to 10 NM in diameter and can grow to 50,000 - 60,000 feet. They can produce updrafts that exceed 90 knots, 6-inch hail, damaging surface winds, and large tornadoes.



**NOTE**

In the following two paragraphs, numbers in parenthesis refer to information found in figure 5-10.

Steady-state thunderstorms begin to form when warm, humid air begins to rise from the earth's surface (#1). As the air rises, mid-level winds (#2) capture a portion of the rising air and redirect it to the surface as a gust front (#3). A person standing on the surface will sometimes experience this gust front as a blast of cool air as a thunderstorm approaches. The gust front acts as a "plow" that lifts additional warm moist air up into the storm system. This cycle of warm moist air being lifted into the system by a gust front that is formed by mid-level winds is what gives the thunderstorm its long life and is the reason it is referred to as a steady-state storm.

Steady-state thunderstorms can generate tremendous updrafts that force the storm to very high altitudes. The updrafts often cause the top of the storm to "overshoot" (#4) the altitude where the tropopause begins. Normally, weather does not form in the tropopause. Very high energy levels are associated with weather that overshoots this boundary. In a mature storm, upper level winds (#5) will cause the top of the storm to form an anvil top (#6) downwind of the main body of the storm. It is common for hail to be "thrown" out of the top of the storm and in the direction of the anvil top. Thus, even though it may appear to be clear under the anvil top, this area should be avoided due to its high probability for hail (#7). This is also one reason thunderstorms should, whenever possible, be circumnavigated on the upwind side.



## WARNING

Extreme turbulence, large hail, and tornadoes are characteristics of steady state thunderstorms.

Figure 5-10 Steady-State Thunderstorm Structure

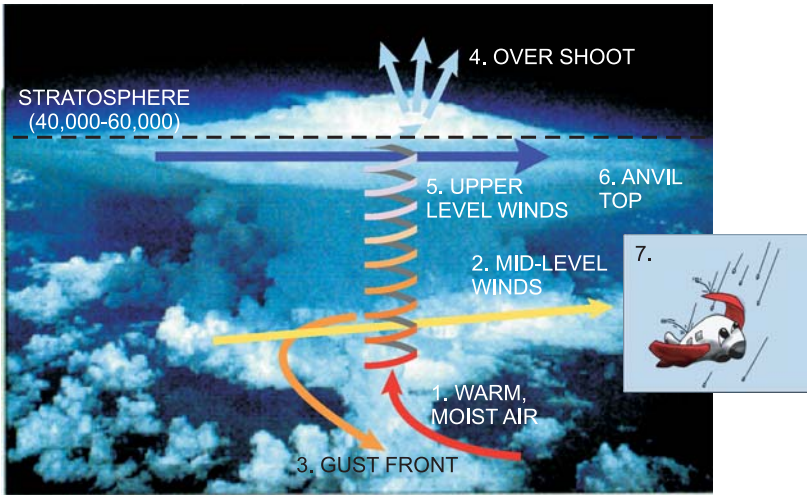

TPG3130\_34

## THUNDERSTORM CHARACTERISTICS

### GUST FRONT/TURBULENT OUTFLOW

Gust fronts occur when a downdraft of cool air from a thunderstorm comes in contact with the ground and spreads out laterally. Someone on the surface in the path of the approaching the storm would experience a gust of cool air much like a cold front passage. The passage of a gust front is accompanied by strong gusty winds that may on occasion exceed 55 knots.

Gust fronts are a form of turbulent outflow that emanates from the thunderstorm. The turbulent outflow can create areas of severe turbulence in much the same way that severe turbulence is associated with frontal boundaries. Figure 5-11 shows a NEXRAD picture of a thunderstorm with the corresponding turbulent outflow. Also note that the gust front/turbulent outflow precedes the thunderstorm and is in the

direction of cell movement. This is another reason that, when possible, thunderstorms should be avoided to the upwind side.

Figure 5-11 NEXRAD Thunderstorm With Turbulent Outflow

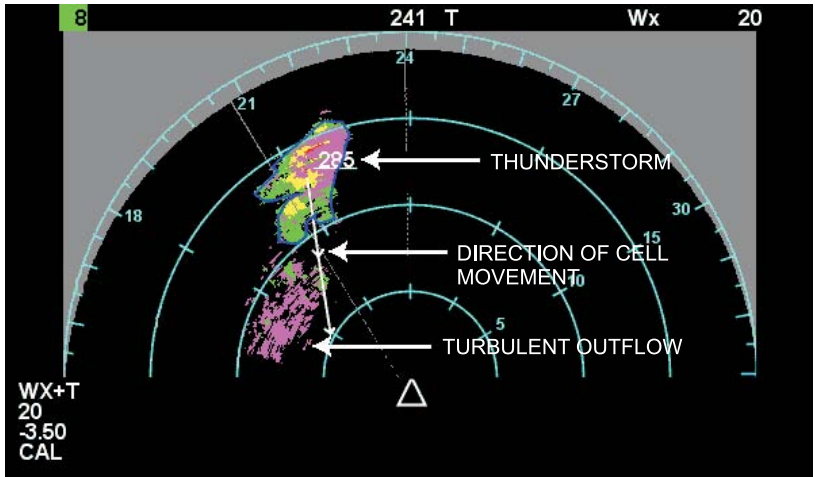

TPG3130\_35

### THUNDERSTORM VAULTING

Thunderstorm “vaulting” occurs when thunderstorm updrafts are so strong that large amounts of moisture are trapped high in the thunderstorm cell and an area of potential energy is formed (figure 5-12). Little precipitation occurs at the bottom of the cloud due to the fact that downdrafts are all but eliminated. This is especially possible as thunderstorms transition from the towering cumulus stage to the mature stage of development (♦page 5-9). At lower altitudes during climb out, it is occasionally possible to miss the true extent of the thunderstorm threat due to the fact that the radar beam may scan below the high-energy area created by the vaulting of moisture high in the storm.



#### NOTE

MultiScan’s high beam scans along or slightly above the aircraft’s climb out flight path to ensure that all potential areas of severe weather are examined.

Figure 5-12 Thunderstorm Vaulting



TPG3130\_36

### **OCEANIC WEATHER CELLS**

Oceanic weather cells tend to have less mass and significantly less reflectivity than continental thunderstorms of equivalent height. Compare the oceanic thunderstorm shown in figure 5-13 with the equivalent height land mass thunderstorm shown in figure 5-5. Interestingly, the reduced mass and lower reflectivity levels found in oceanic weather cells occur due to the fact that they have, on average,

less water content than do thunderstorms that form over land. As a result, a higher gain setting and/or a lower tilt setting may be required to adequately detect thunderstorm threats at higher cruise altitudes.

It is not unusual for oceanic weather cells to be very “skinny” but still have significant vertical development, especially in equatorial regions (figure 5-14). This type of thunderstorm has very little moisture content and is extremely difficult for radar to see. The anvil tops on these type storms can extend for several mile (figure 5-15) and may be almost invisible to radar. At night it may be necessary to look for an area where stars are blocked by the thunderstorm cell to prevent inadvertent thunderstorm top penetration.



**NOTE**

During automatic MultiScan operation, the radar automatically adjusts gain and tilt in oceanic regions to more accurately depict oceanic weather cells (♦page 4-43).

*Figure 5-13 Oceanic Weather Cell*



TPG3130\_37

*Figure 5-14 “Skinny” Oceanic Weather Cell*

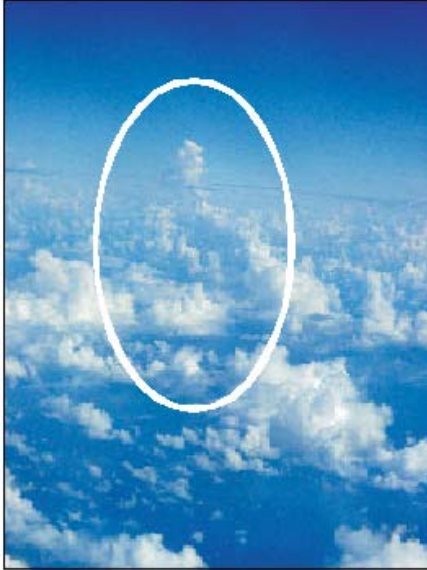

TPG3130\_38

*Figure 5-15 “Anvil Top” Oceanic Weather Cell*



TPG3130\_39

## SQUALL LINES

Squall lines are organized lines of thunderstorms that form in both mid-latitudes and the tropics and may extend for as long as 500 NM. Mid-latitude squall lines are classified as either “ordinary” or “prefrontal”. Prefrontal squall lines (figure 5-17) form in front of cold fronts. They may form right in front of the cold front boundary, but the most severe lines precede the cold front by as much as 150 NM. Research is ongoing as to how these kind of lines form, but one theory holds that the cold front may cause air at higher altitudes to form “waves” (called gravity waves) that then cause the thunderstorms to form ahead of the advancing front. It is known that the thunderstorms in this type of squall line are massive and can contain strong winds, hail and sometimes tornadoes. Ordinary squall lines normally exhibit weaker updrafts and down drafts, have shorter life spans, and have less severe thunderstorms than prefrontal squall lines. Squall lines in the tropics tend to have a structure that is similar to ordinary mid-latitude squall lines.

Figure 5-16 Prefrontal Squall Lines

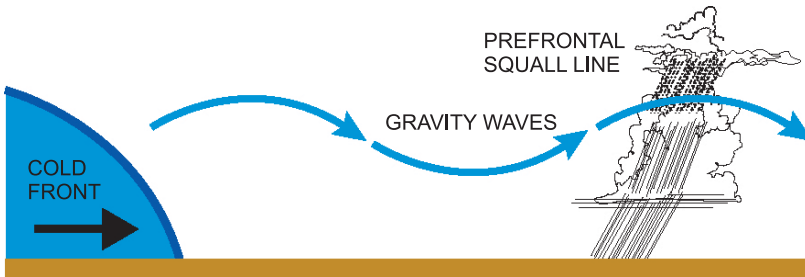

TPG3130\_40



Figure 5-17 Prefrontal Squall Lines Weather Radar Display

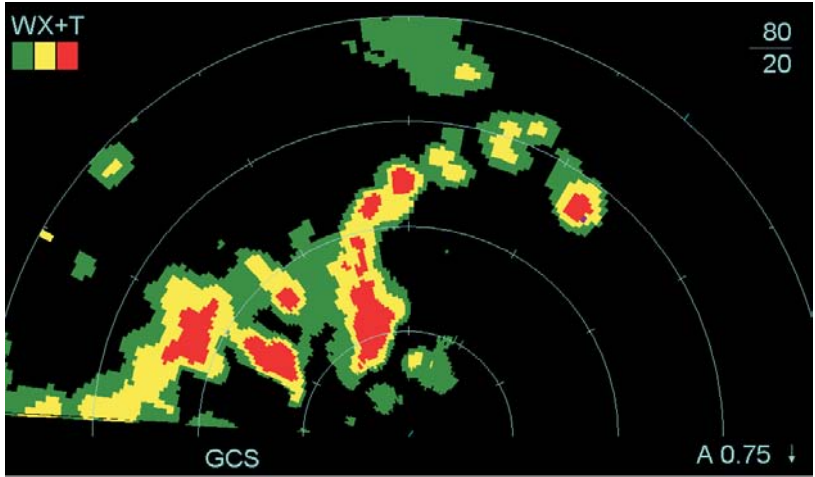

TPG3130\_41

## **MICROBURSTS AND WINDSHEAR**

### **MICROBURSTS**

Microbursts can be an extreme hazard to aircraft during the landing and take off phases of flight. Microbursts normally cover an area approximately 2 NM in diameter, although the area of resulting high winds created when the microburst hits the ground can be much higher. Winds of up to 130 knots may result when a microburst is formed. However, it should be remembered that on occasion microbursts may produce windshear events that are small enough to pass unnoticed between the low-level windshear sensors that are installed at some airports.

Microburst typically occur in the vicinity of thunderstorms when the surrounding air is dry. In general, the dry air causes the rain from the thunderstorm to evaporate. The process of evaporation cools the dry air which then becomes heavier than the surrounding air. This cooler, heavier air then plunges to the surface (figure 5-18).

*Figure 5-18 Microburst Formation*



TPG3130\_42

When the microburst reaches the surface, it spreads out from the point of impact. A stationary thunderstorm produces a microburst that spreads in a 360-degree circle from the initial point of impact (left image, figure 5-19). However, most thunderstorms are in motion and cause the microburst to move in the direction of the storm (right image, figure

5-19). This movement distorts the circular air flow of the microburst so that it becomes elliptical. In these cases, the edge of the ellipse that is at the front of the storm produces the strongest winds and the trailing edge has somewhat weaker winds.

*Figure 5-19 Stationary and Moving Microburst Impact Patterns*

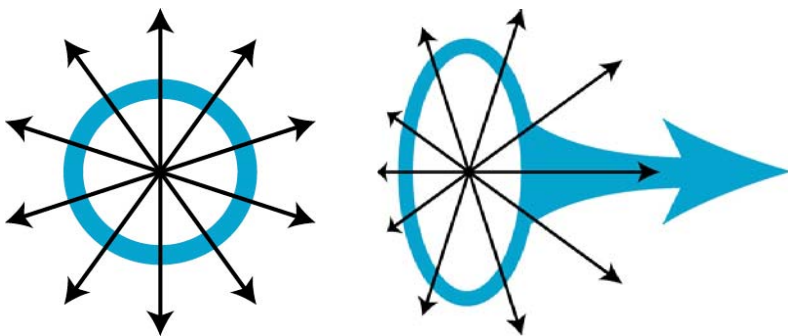

TPG3130\_43

Microbursts are classified as either “wet” or “dry”. Wet microbursts occur when a thunderstorm draws in dry air from the surrounding atmosphere. The dry air evaporates rain within the thunderstorm, which causes the air to cool. This cooler, heavier air then plunges towards the ground. In this scenario, heavy rain from the thunderstorm may completely mask the actual microburst.

Dry microbursts occur when the air below the thunderstorm is dry. In this case, rain from the thunderstorm evaporates as it descends towards the surface. This evaporation causes the air to cool. This cooler, heavier air then plunges towards the ground. In this situation, the only evidence of a microburst may be dust kicked up by the wind when it impacts with the ground.

Rain that evaporates before it reaches the ground is known as virga. An observer on the surface would see this as wisps of rain coming from the cloud but disappearing before they reached the ground. Similarly, as an aircraft descends, virga is sometimes evident on the radar. Notice how the rain shower in figure 5-21 dissipates as the aircraft descends. Dry air below the thunderstorm is causing the rain to evaporate. When the radar displays rain at higher altitudes but the rain disappears as the aircraft descends, virga is present and the conditions are right for the formation of a dry microburst.

Figure 5-20 shows a weather radar display for an aircraft flying at 5,000 feet with a display range of 40 NM. Thunderstorms are visible in the lower left corner, and a significant rain shower is visible in the middle right.

Figure 5-20 Weather Radar Rainfall Display

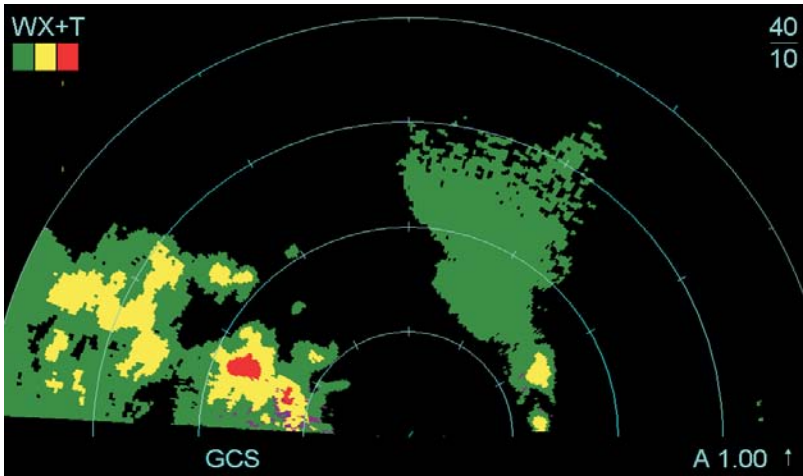

TPG3130\_44

Figure 5-21 shows a sequence of weather radar displays as the aircraft descends to 2,500 feet over a period of approximately 2 1/2 minutes with the display range set to 20 NM. Note how the display shows rainfall evaporating as the aircraft descends. This sequence of displays indicates conditions are right for the formation of a dry microburst event.

Figure 5-21 Weather Radar Virga Display

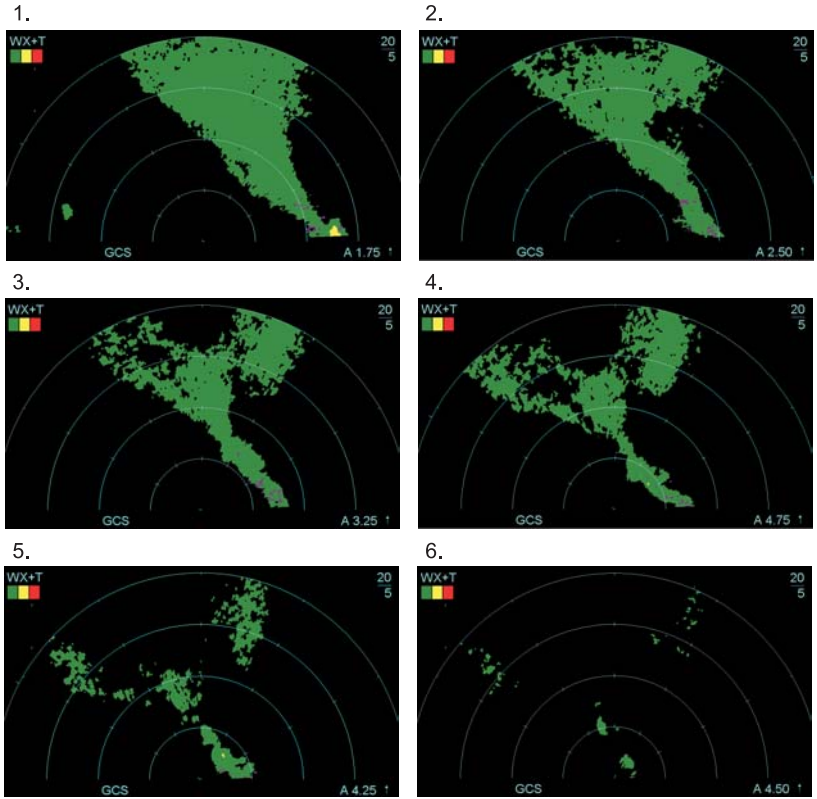

TPG3130\_45

## WINDSHEAR

Although the downdraft from a microburst can be dangerous to an aircraft, the greatest threat comes from the change in wind direction — commonly called windshear — near the center of the microburst which may result in a corresponding loss of airspeed. The following paragraphs and associated figures provide an example of how a windshear event can affect an aircraft landing.

Consider the following example of a microburst that produces a 40-knot horizontal windshear. In this example (figure 5-22), the aircraft is on approach with an air speed of 130 knots, 300 pounds thrust (power) and an initial altitude of 400 meters.

Figure 5-22 Windshear Example — Approach Conditions

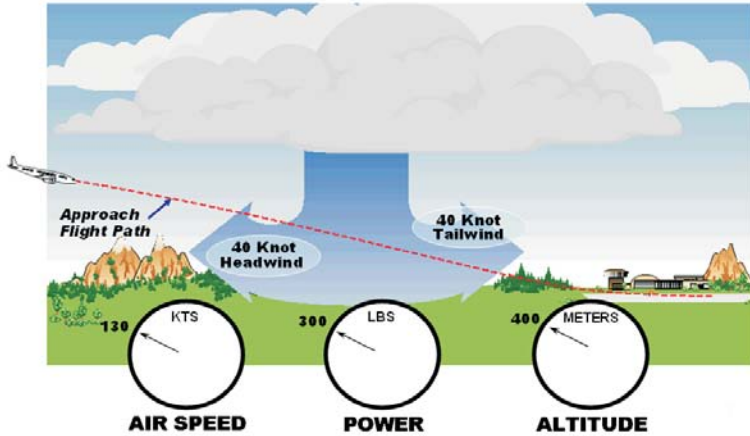

TPG3130\_46

When the aircraft enters the leading edge of the windshear zone, the indicated air speed jumps from 130 to 170 knots due to the additional airflow (headwind) over the wing (figure 5-23). An unexpected increase in aircraft performance is, thus, often the first clue that a windshear event has been encountered.

Figure 5-23 Windshear Example — Headwind Zone

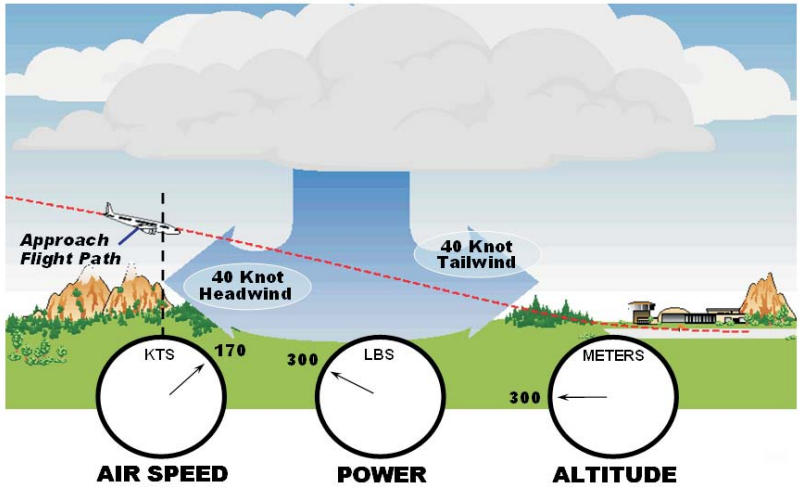

TPG3130\_47

The increased approach speed will tend to make the aircraft float above the approach course. Because the aircraft is high and fast, the natural tendency is then to reduce power (figure 5-24). In this example, the power has been reduced to zero pounds thrust.

Figure 5-24 Windshear Example — Power Reduction

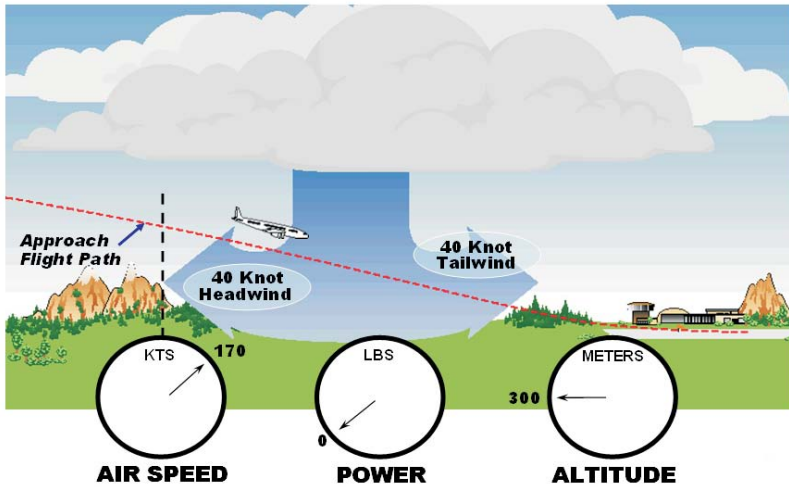

TPG3130\_48



The extreme danger point during a windshear event is when the aircraft passes through the center. At this point (figure 5-25), the 40-knot headwind turns very rapidly into a 40-knot tailwind so that indicated airspeed suddenly drops from 170 knots to 90 knots. Power is still zero and approach altitude has decreased to 200 meters. The aircraft is now low, slow, and without power.

*Figure 5-25 Windshear Example — Indicated Airspeed Transition*

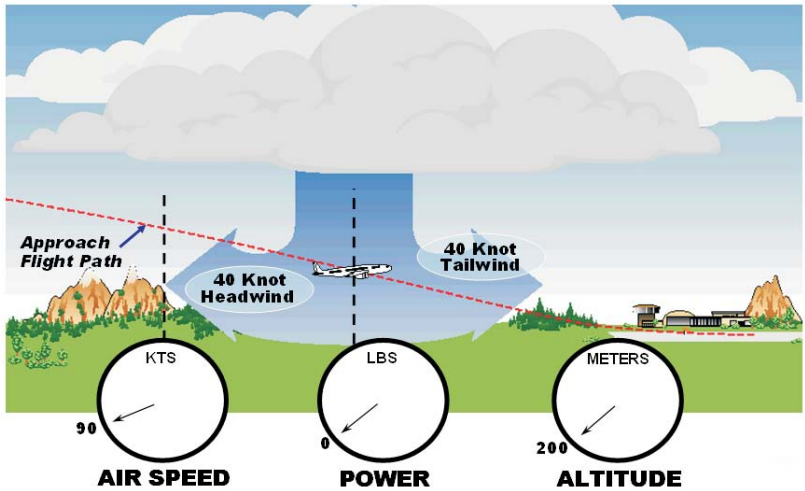

TPG3130\_49

If there is sufficient time and altitude and if the windshear is not overly severe, addition of power may allow the crew to fly through the windshear event. However, recovery from the windshear event and associated actions described in this example would be unlikely (figure 5-26).

Figure 5-26 Windshear Event — Recovery or Loss of Flight

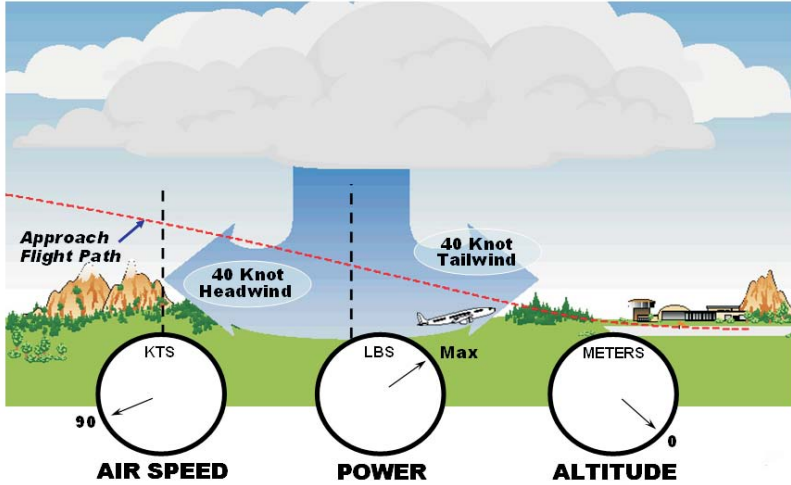

TPG3130\_50

**WARNING**

Windshear resulting from a microburst can be an extreme hazard during take off and landing.

# HAZARDOUS WEATHER

## INTRODUCTION

A normal thunderstorm is circular or oval in shape (figure 5-27). Variations from this normal shape are indicative of a shear condition within the thunderstorm and can serve as clues to hazardous weather (figure 5-28).

Figure 5-27 Normal Thunderstorm Shape

NORMAL THUNDERSTORMS ARE  
CIRCULAR OR OVAL IN SHAPE

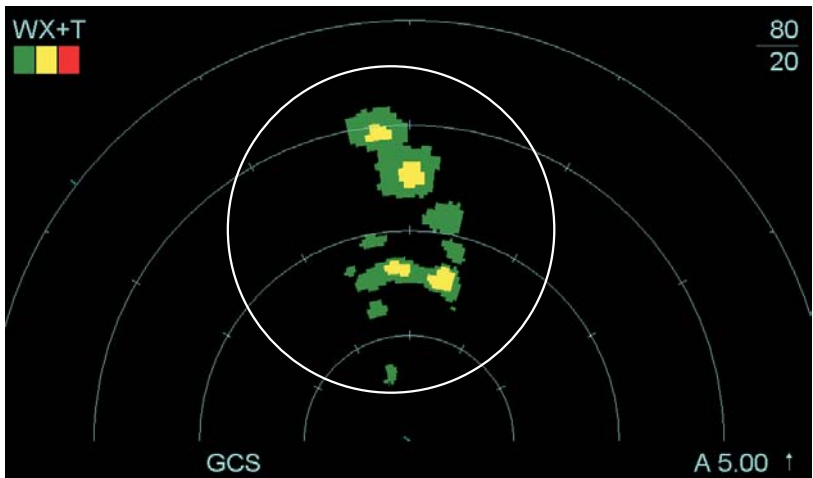
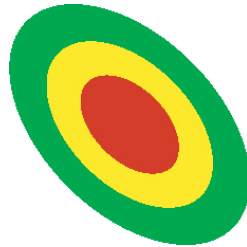

TPG3130\_51

Figure 5-28 Shear Conditions within Thunderstorm Shape

SHEAR CONDITIONS WITHIN THE THUNDERSTORM DISTORT THE NORMAL SHAPE OF THE CELL AND ARE INDICATIVE OF TURBULENCE.

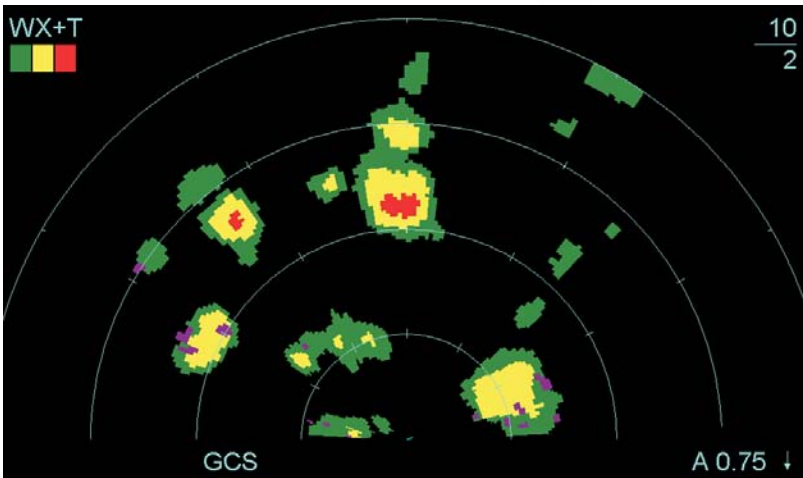

TPG3130\_52

## STEEP GRADIENT

A steep gradient occurs when the green and yellow portions of the thunderstorm shown on a weather radar display merge very rapidly into red (figure 5-29). A steep gradient is indicative of significant convective activity and heavy turbulence.

Figure 5-29 Steep-Gradient Thunderstorm

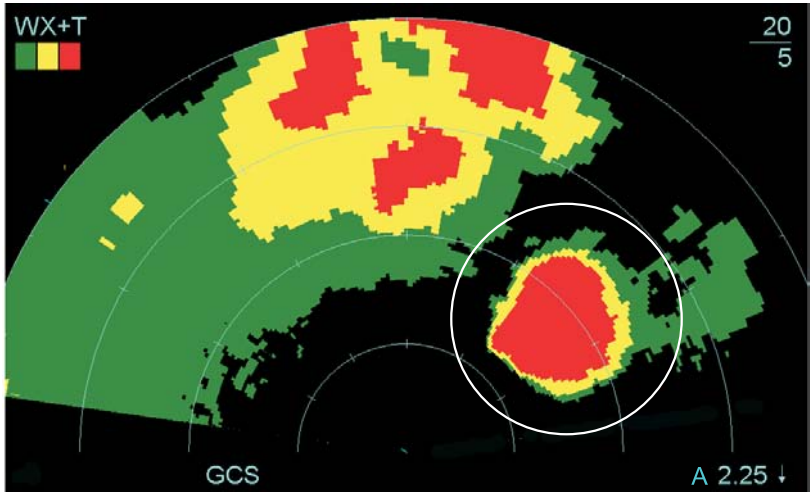

TPG3130\_53

The circled thunderstorm in figure 5-29 has a steep gradient because the green and yellow portions of the cell quickly move to red. A steep gradient is indicative of extensive convective activity, and severe turbulence would more than likely be encountered if the aircraft penetrated the thunderstorm.

## **SCALLOPED EDGES, PENDANT, FINGER, HOOK, U-SHAPE**

Scalloped or roughened edges (figure 5-30), pendants (figure 5-31), fingers (figure 5-32), hooks (figure 5-33), and U-shapes (figure 5-34) on weather radar thunderstorm displays all indicate the presence of shear forces and turbulence. They may also indicate the presence of hail.



### **WARNING**

Increase the avoidance distances by 50 percent for echoes that are changing shape rapidly or are exhibiting hooks, fingers, or scalloped edges.

*Figure 5-30 Thunderstorm Showing Scalloped Edges*

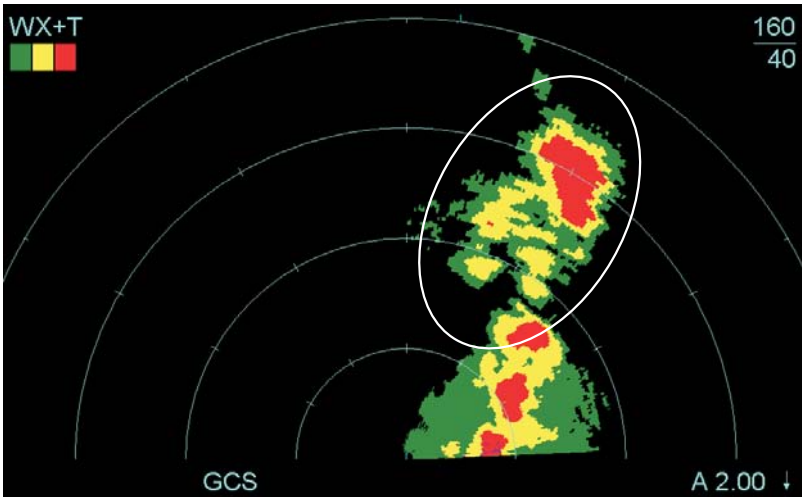

TPG3130\_54

Figure 5-31 Thunderstorm Showing Pendants

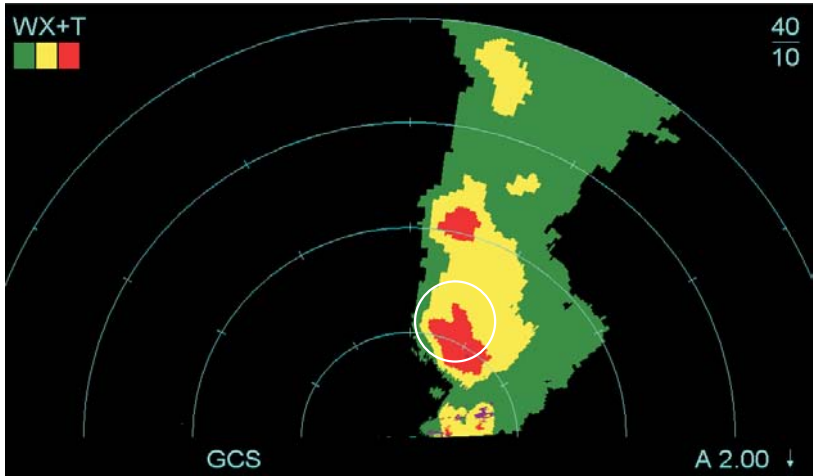

TPG3130\_55

Figure 5-32 Thunderstorm Showing Fingers

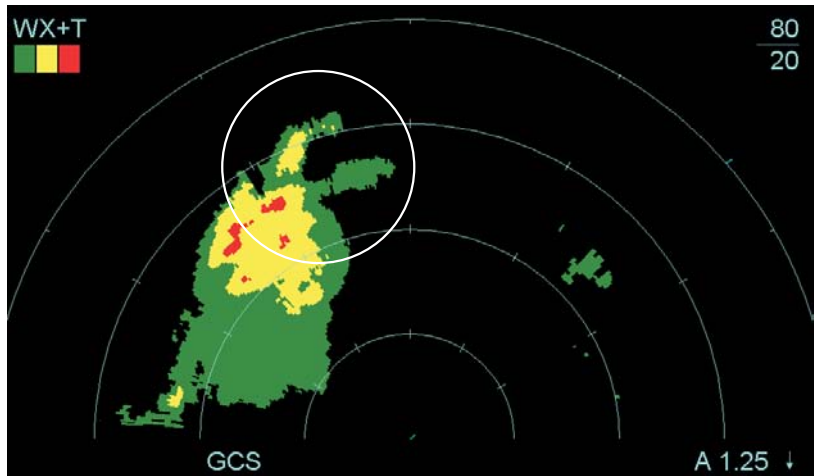

TPG3130\_56

Figure 5-33 Thunderstorm Showing A Hook

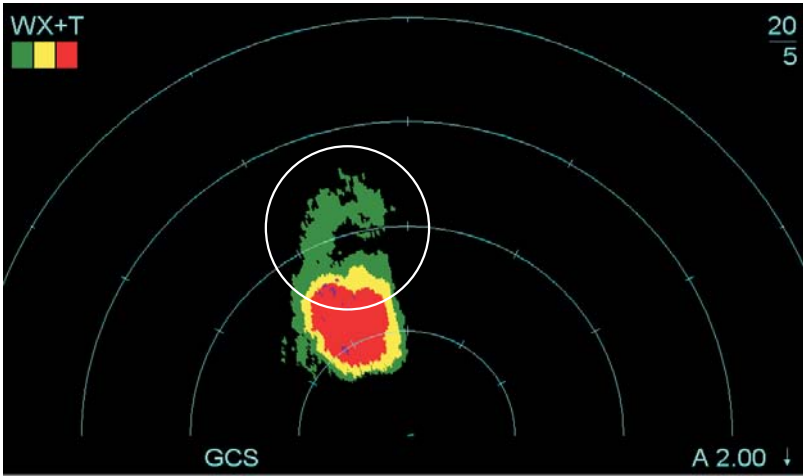

TPG3130\_57

Figure 5-34 Thunderstorm Showing A U-Shape

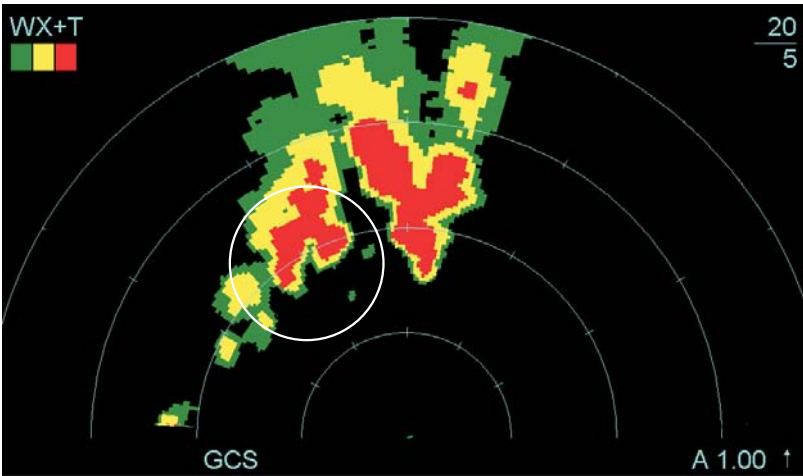

TPG3130\_58



## ***NON-REFLECTIVE WEATHER***

Stratiform clouds and small cumulous cloud buildups often do not contain enough moisture to reflect radar energy (♦page 6-4). Note that even though small cumulous cloud buildups that resemble popcorn or cotton balls (figure 5-35) seldom reflect radar energy, they are still associated with light to moderate turbulence.

*Figure 5-35 Popcorn-Shaped Cumulous Cloud Buildups*



TPG3130\_59

These popcorn-shaped clouds are formed when warm moist air rises, then cools to the dew point. When this occurs, the air is saturated with moisture and a cloud forms. The clear air spaces between these clouds represent areas of downdraft where the cloud dissipates. The resulting turbulent air can make for a bumpy ride (figure 5-36).

*Figure 5-36 Popcorn-Shaped Cumulous Cloud Turbulence*

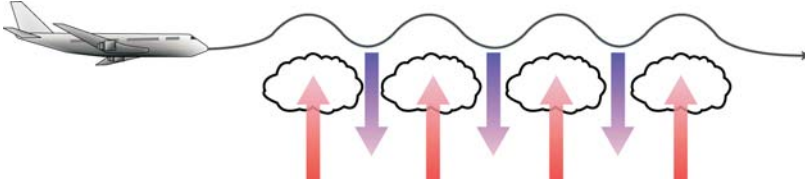

TPG3130\_60

## **TABLE OF CONTENTS**

Title	Page
The Radar System .....	6-1
Frequency Comparison .....	6-2
Gain .....	6-4
Calibrated Gain Color Scheme .....	6-4
Gain Control Settings .....	6-5
Gain Tables .....	6-6
Airbus .....	6-6
Boeing .....	6-7
Effects Of Gain Selection .....	6-8
Antenna Characteristics .....	6-12
Parabolic Versus Flat-Plate Antennas .....	6-12
Antenna Side Lobes and False Windshear Warnings .....	6-14
Antenna Calibration .....	6-16
Antenna Stabilization .....	6-17
Radar Beam Characteristics .....	6-19
Beam Diameter .....	6-20
Range And Azimuth Resolution .....	6-21
Beam Attenuation .....	6-23
Sensitivity Time Control (STC) .....	6-24
Long-Range Color Enhancement .....	6-26
Path Attenuation (Radar Shadow) .....	6-27
Radome Characteristics .....	6-30
Cat's Eyes/Ghost Targets .....	6-30
Radome Inspection .....	6-31
Doppler Turbulence .....	6-32
Windshear .....	6-33
Windshear Event .....	6-33
Automatic Enable .....	6-35
Collins' Windshear Philosophy .....	6-36
Alert Level Activation Regions .....	6-39
Airbus .....	6-40
Boeing .....	6-42
MVD™ Windshear Recording .....	6-43

Title	Page
Alien Radar .....	6-44
Radiation Hazards .....	6-44

## HOW RADAR WORKS

### THE RADAR SYSTEM

The critical factor for weather detection for any radar is “loop gain”. Loop gain is defined as the difference between the signal generated by the transmitter and the signal processed by the receiver (figure). A high power output combined with a sensitive receiver yields a high loop gain, which allows the weather signal to be processed and separated from atmospheric noise. Although many factors affect loop gain performance, four of the primary ones are:

- R/T power output and pulse width (the more the better)
- Receiver sensitivity (the more sensitive the better)
- Flat-plate antenna technology (how well the antenna focuses the radar beam)
- Radome performance (how transparent the radome is)

Figure 6-1 Loop Gain (Signal to Noise Ratio)

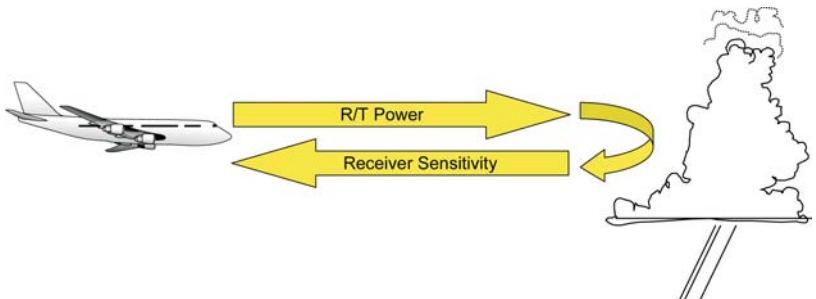

TPG3130\_25

The block diagram shown in figure 6-2 identifies the major components of the WXR-2100 weather radar system.

Figure 6-2 WXR-2100 Weather Radar System Block Diagram

- WXR-2100 BLOCK DIAGRAM. MAJOR COMPONENTS INCLUDES:
- (1) RECEIVER/TRANSMITTER (R/T),
  - (2) ANTENNA,
  - (3) RADOME,
  - (4) CONTROL PANEL
  - (5) DISPLAY

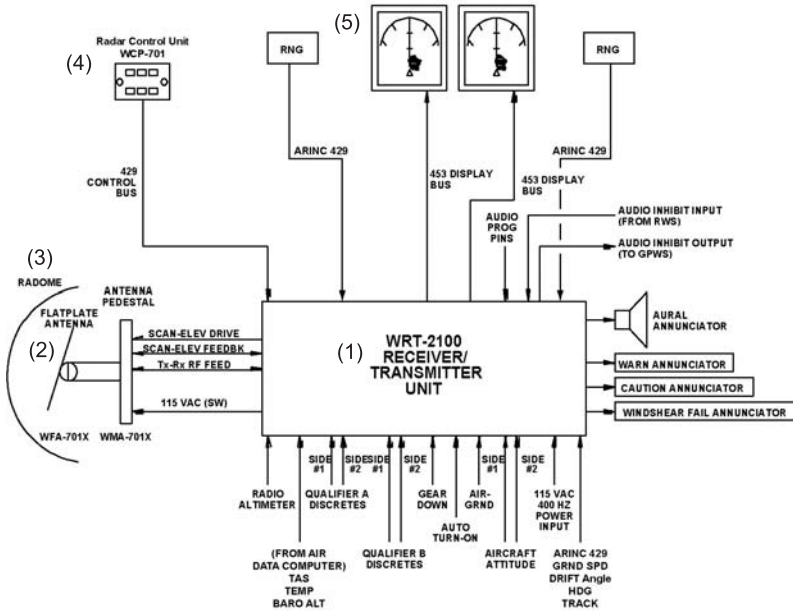

TPG3130\_26

## FREQUENCY COMPARISON

A comparison of several different frequencies provides a better understanding of both the capabilities and limitations of radar. Consider, for example, the warning buoy pictured in figure 6-3. The bell or horn in the buoy emits a low-frequency audio signal that penetrates all forms of weather, which is just what you would expect since its primary job is to be heard and warn of impending danger. Medium and high frequencies such as those emitted by airborne HF radios

also experience minimal interference from precipitation (figure 6-4). However, very high frequencies (VHF) begin to be scattered or reflected by very heavy precipitation (figure 6-5). This is the reason that pilots sometimes experience static on their VHF radios during very heavy rain. When the frequency is high enough that it begins to be affected by weather, it then becomes possible to start considering weather detection and interpretation.

Figure 6-3 Low Audio Frequency Propagation Through Weather

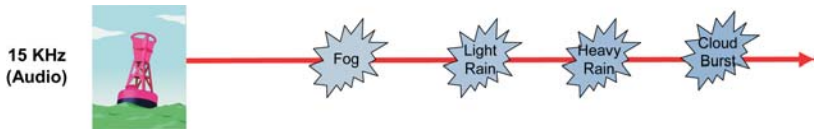

TPG3130\_61

Figure 6-4 Medium and High Frequency (MF/HF) Propagation Through Weather

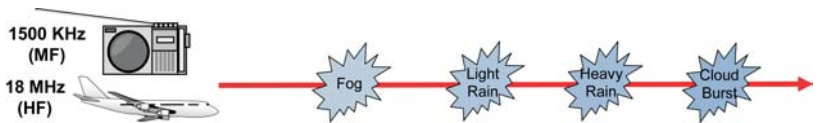

TPG3130\_62

Figure 6-5 Very High Frequency (VHF) Propagation Through Weather

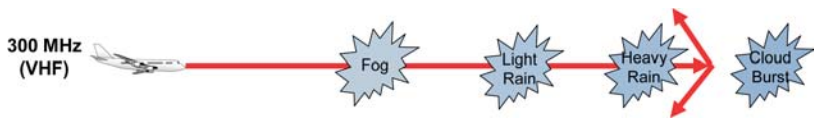

TPG3130\_63

Radar, which is an acronym for Ra(dio) D(etecting) A(nd) R(anging), utilizes high frequency transmissions that are optimized to reflect a particular type of target. For instance, air controllers use primarily L - Band radars that do a good job of penetrating most weather and detecting aircraft (figure 6-6). This makes sense since the controller's primary job is aircraft separation, not weather detection and avoidance. Since an air controller's radar detects only the heaviest precipitation, it

is also the reason pilots should take seriously a controller's warning of weather in the aircraft flight path.

Most airborne weather radars operate in the X-Band and are specifically designed to both penetrate and reflect weather. In figure 6-6, the reflection of light rain can be equated with green on the radar display. Moderate rain can be equated with yellow and heavy rain can be equated with red. Note, however, the compromise that is involved. In order to be able to penetrate heavy rain, radar will not be able to detect fog, very light rain or relatively dry clouds. On the other end of the spectrum, radar's ability to reflect light rain may prevent the radar beam from penetrating heavy rain and thus may mask weather behind a storm cell (♦page 6-27).

Figure 6-6 Radar Operating Bands

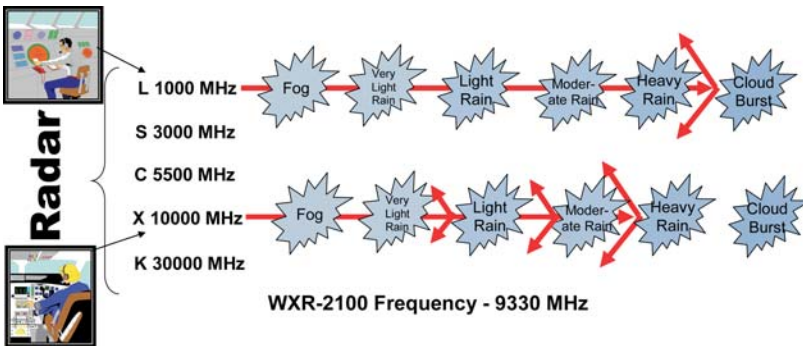

TPG3130\_64

**NOTE**

The L, S, C, X and K Band designations for radar frequencies have no intrinsic meaning. These letters were chosen at random during Word War II to represent the different frequency ranges.

## GAIN

### CALIBRATED GAIN COLOR SCHEME

At a basic level, weather radar measures the amount of moisture present in the atmosphere. Calibrated gain within the weather radar's



circuitry associates these different amounts of moisture (or rainfall rates) with a particular color level on a weather radar display (see figure 6-7). For instance, **green** represents a weak rainfall rate of 0.03 to 0.15 inches/hour (in/hr), while **red** represents a rainfall rate that is greater than 0.5 in/hr. Note that **black** is also a color level. Black on a weather radar display does not mean that weather is not present (although this may be the case), it simply means that the rainfall rate is less than 0.03 in/hr.

Also note that each color level represents a change of 10 dBz (**green** is 20 dBz, **yellow** is 30 dBz, and **red** is 40 dBz or greater). Therefore, changing the gain by 10 dBz above or below the **CAL** setting will change the display by one color level.

**Magenta** represents turbulent airflow that, in essence, represents variations in raindrop movement of greater than 5 meters/second. Doppler turbulence detection is described in detail later in this section (♦page 6-32).

Figure 6-7 Calibrated Gain Color Scheme

- 
- **Black** (Less Than .76 mm/hr [.03 in/hr])
  - **Green: Weak** (.76 - 3.81 mm/hr [.03-.15 in/hr] - 20 dBz)
  - **Yellow: Moderate** (3.81 - 12.7 mm/hr [.15-.5 in/hr] - 30 dBz)
  - **Red: Strong to Very Strong** (12.7 mm/hr [.5 in/hr] and Greater - 40 dBz and greater)
  - **Magenta: Turbulence** (Greater than 5 meters/second wind velocity)

TPG3130\_65

## GAIN CONTROL SETTINGS

The GAIN control allows manual adjustment of the radar sensitivity for a more detailed assessment of weather conditions. The Calibrated (**CAL**) position sets the radar sensitivity to the standard calibrated reflectivity levels and is the recommended position for normal operation. If desired,

the radar gain may be adjusted to increase sensitivity by rotating the GAIN control clockwise from the CAL position or to decrease the sensitivity by rotating the GAIN control counterclockwise from the **CAL** position. The GAIN control settings and the corresponding sensitivity changes are contained in the following tables.

## **GAIN TABLES**

### **AIRBUS**

Airbus gain settings correspond to the nomenclature on the Airbus weather radar control panel (♦page 4-1). There is no EFIS indication when **CAL** (calibrated) gain is selected. **MAN GAIN** is displayed whenever gain is selected to other than the **CAL** position (♦page 4-4).

#### *Airbus Gain Settings*

<b>WX, WX+T Modes</b> (see Notes 1 and 2 below)		
<b>Knob Position</b>	<b>Gain Change</b>	<b>EFIS Indication</b>
MAX	+16 dB	MAN GAIN
+12	+12 dB	MAN GAIN
+8	+8 dB	MAN GAIN
+4	+4 dB	MAN GAIN
CAL	+0 dB	
-3	-3 dB	MAN GAIN
-6	-6 dB	MAN GAIN
-9	-9 dB	MAN GAIN
-12	-12 dB	MAN GAIN
MIN	-14 dB	MAN GAIN
Note 1: Path Attenuation Compensation (PAC) is disabled for all non-CAL gain settings.		
Note 2: The CAL gain in the MAP mode is approximately 10 dB less sensitive for weather targets than CAL gain is in the WX or WX+T modes due to the different nature of ground and weather targets.		

## **BOEING**

On Boeing aircraft, maximum gain is achieved when the GAIN knob is rotated to its fully clockwise (CW) position. Minimum gain is achieved when the GAIN knob is rotated to its fully counterclockwise (CCW) position. **CAL** (calibrated) gain is selected when the black triangle (▼) is rotated to the 12 o'clock position (♦page 4-2). Intermediate gain positions are achieved by selecting the various detents between these three positions. There is no EFIS indication when **CAL** (calibrated) gain is selected. VAR (variable) is displayed whenever gain is selected to other than the **CAL** position (♦page 4-7).

### *Boeing Gain Settings*

<b>WX, WX+T Modes</b> (see Notes 1 and 2 below)		
<b>Knob Position</b>	<b>Gain Change</b>	<b>EFIS Indication</b>
Fully CW	+16 dB	VAR
	+8 dB	VAR
	+4 dB	VAR
CAL	+0 dB	
	-2 dB	VAR
	-4 dB	VAR
	-6 dB	VAR
	-8 dB	VAR
	-12 dB	VAR
Fully CCW	-14 dB	VAR
Note 1: Path Attenuation Compensation (PAC) is disabled for all non-CAL gain settings.		
Note 2: The CAL gain in the MAP mode is approximately 10 dB less sensitive for weather targets than CAL gain is in the WX or WX+T modes due to the different nature of ground and weather targets.		

## EFFECTS OF GAIN SELECTION

Figures 6-8 through 6-12 show the weather returns for each gain position on a Boeing control panel. (Airbus control panels positions produce similar returns.) **MAX** gain (+16 dB) is equivalent to an approximately one and a half color level increase. **MIN** gain (-14 dB) is equivalent to an approximately one and half color level decrease (♦page 6-4).

Figure 6-8 Radar Displays with Gain set to **MIN** and -12 dB

MIN GAIN (-14 dB)  
IS EQUIVALENT TO  
A 1.4 COLOR LEVEL  
DECREASE



-12 dB IS EQUIVALENT  
TO A 1.2 COLOR LEVEL  
DECREASE



TPG3130\_66

*Figure 6-9 Radar Displays with Gain set to -8 dB and -6 dB*

-8 dB IS EQUIVALENT  
TO A .8 COLOR LEVEL  
DECREASE



-6 dB IS EQUIVALENT  
TO A .6 COLOR LEVEL  
DECREASE

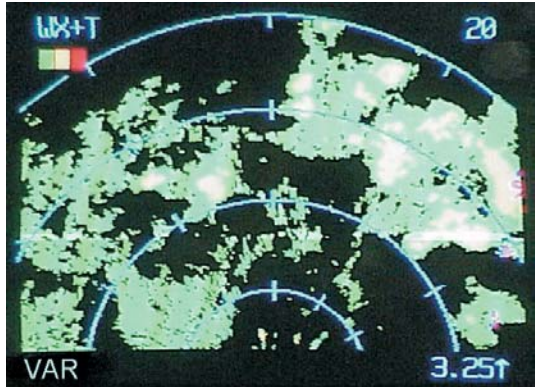

TPG3130\_67

Figure 6-10 Radar Displays with Gain set to  $-4$  dB and  $-2$  dB

$-4$  dB IS EQUIVALENT  
TO A .4 COLOR LEVEL  
DECREASE

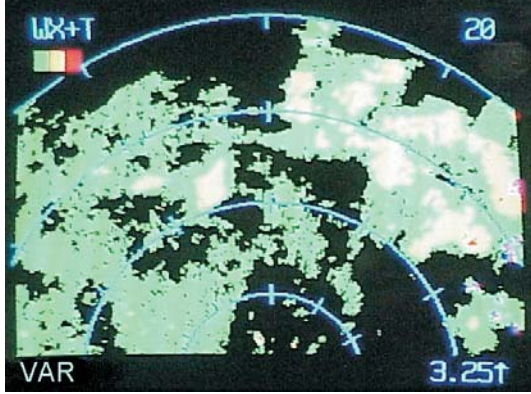

$-2$  dB IS EQUIVALENT  
TO A .2 COLOR LEVEL  
DECREASE



TPG3130\_68

Figure 6-11 Radar Displays with Gain set to **CAL** and **+4 dB**

CAL (CALIBRATED)  
GAIN (+0 dB). CAL  
GAIN YIELDS THE  
MOST ACCURATE  
CORRELATION OF  
COLOR LEVELS  
WITH ACTUAL  
RAINFALL RATES.

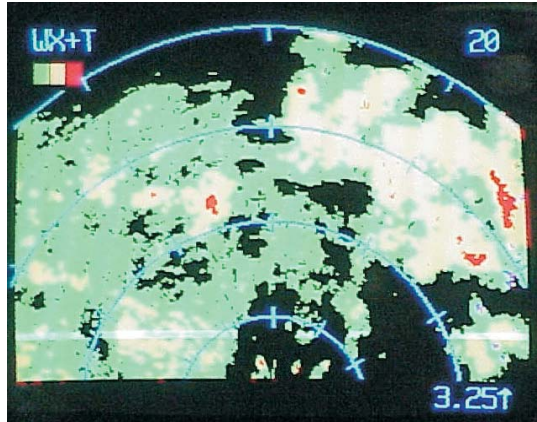

+4 dB IS EQUIVALENT  
TO A .4 COLOR LEVEL  
INCREASE

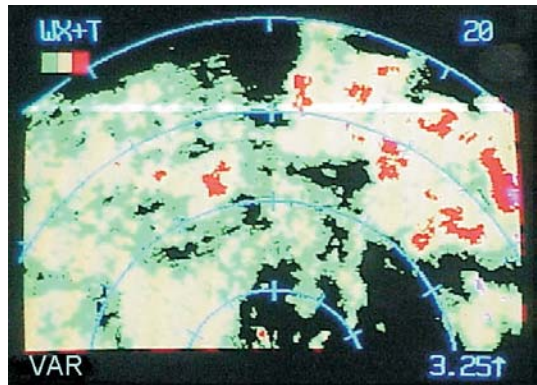

TPG3130\_69

*Figure 6-12 Radar Displays with Gain set to +8 dB and MAX*

+8 dB IS EQUIVALENT  
TO A .8 COLOR LEVEL  
INCREASE

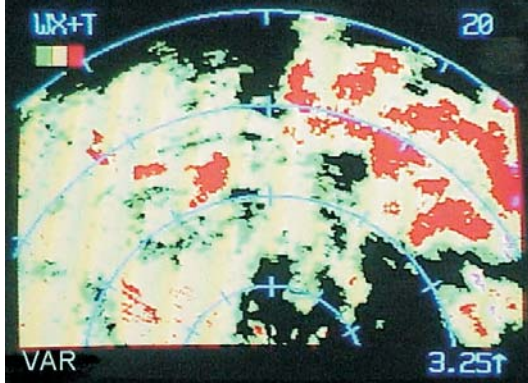

MAX GAIN (+16 dB) IS  
EQUIVALENT TO A  
1.6 COLOR LEVEL  
INCREASE



TPG3130\_70

## **ANTENNA CHARACTERISTICS**

### **PARABOLIC VERSUS FLAT-PLATE ANTENNAS**

Older parabolic antennas used with magnetron radars produce a large main beam and extensive side lobes. The width of the main beam produces less precise weather returns than current generation flat-plate antennas. The large side lobes can produce ground clutter range rings and also make it impossible to use this type of radar for windshear detection. However, the side lobes do have the benefit of providing



some “look down” capability below the aircraft and can help prevent inadvertent thunderstorm top penetration at high altitudes (figure 6-13).

*Figure 6-13 Parabolic Radar Antenna Beam Patterns*



TPG3130\_71

Flat-plate antennas produce a much more focused beam of energy with small side lobes. Since nearly all of the energy is focused in the main beam, this kind of radar produces better target definition (i.e., a more accurate display of precipitation). Ground clutter is significantly reduced and forward-looking windshear applications are possible. However, **due to the fact that the side lobes do not provide any “look down” capability, tilt control becomes much more important in preventing inadvertent thunderstorm top penetrations** (figure 6-14).

*Figure 6-14 Flat-Plate Radar Antenna Beam Patterns*



TPG3130\_72

## **ANTENNA SIDE LOBES AND FALSE WINDSHEAR WARNINGS**

Echoes from strong targets detected by antenna side lobes (figure 6-15) can mimic a microburst signature and contribute to false alerts. Side lobes occur with all radar antennas but may be more pronounced if the antenna is damaged or the radome is degraded (♦page 6-31). Figure 6-16 shows a main radar beam with minimal side lobes. Figure 6-17 shows an antenna that has been modified to simulate severe damage. The result is extensive side lobes. The effects of side lobes can be reduced with precision antenna manufacturing. For instance, Collins' windshear antenna reduces side lobes 10-15% below those of previous generation non-windshear antennas.

*Figure 6-15 Weather Radar Antenna Side Lobes*

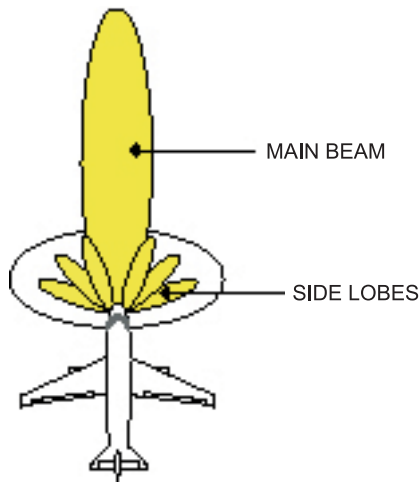

TPG3130\_73

Figure 6-16 New Radar Antenna Showing Minimal Side Lobes

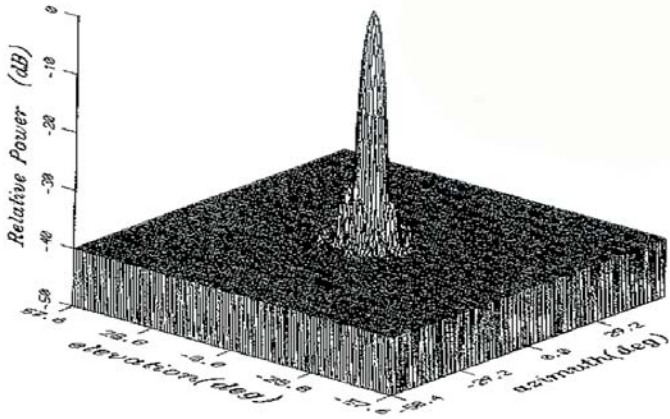

TPG3130\_74

Figure 6-17 Degraded Radar Antenna Showing Extensive Side Lobes

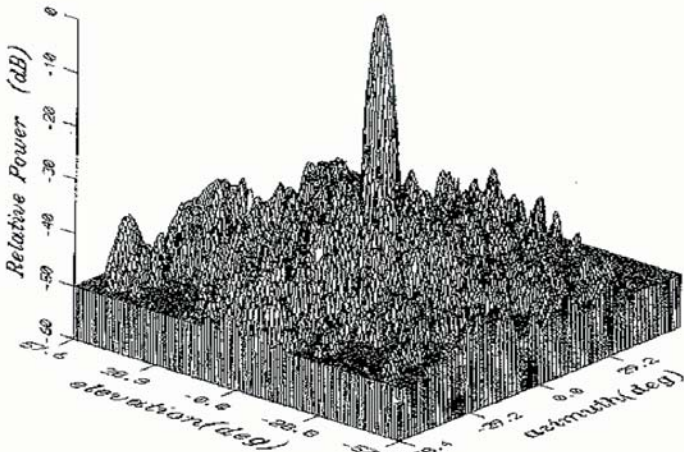

TPG3130\_75

## **ANTENNA CALIBRATION**

Air transport ARINC 708A radars are bore sighted using laser calibration at the aircraft OEM's facility during installation. The radar contains bore sight and incremental sensors that detect variation from the original factory setting. If the sensors detect a variation in the tilt or horizontal angle, an antenna fail message is sent to the display. In other words, **it is not necessary to attempt a manual calibration with ARINC 708A radars**. The tilt that is displayed on the display will be accurate.



### **NOTE**

If the tilt displayed on the EFIS and the control knob tilt disagree, the displayed EFIS tilt is the correct indication.

## ANTENNA STABILIZATION

For the WXR-2100, antenna stabilization (roll and pitch axis) is always active. Stabilization enables the antenna to maintain a sweep parallel to the horizon regardless of the aircraft's attitude (aircraft image, figure 6-18). If ground clutter is set in the outermost range scale (radar image, figure 6-18), stabilization will keep the clutter ring equal across the display even when the aircraft is maneuvering.

*Figure 6-18 Stabilized Radar Antenna Orientation versus Aircraft Attitude*

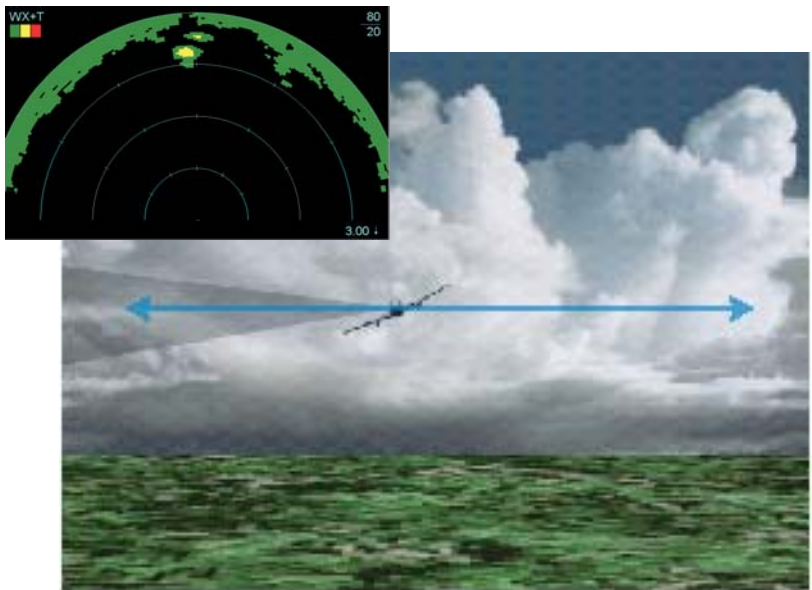

TPG3130\_76

If for any reason stabilization should fail, the radar antenna defaults to a sweep that is parallel to the wings. If an aircraft with an unstabilized antenna makes a turn, the antenna will scan towards the sky during half of the sweep and towards the earth for the other half of the sweep (aircraft image, figure 6-19). When the antenna is pointed towards the earth it will “dig” into the ground and produce a red “cone” of ground clutter (radar image, figure 6-19).

*Figure 6-19 Unstabilized Radar Orientation versus Aircraft Attitude*

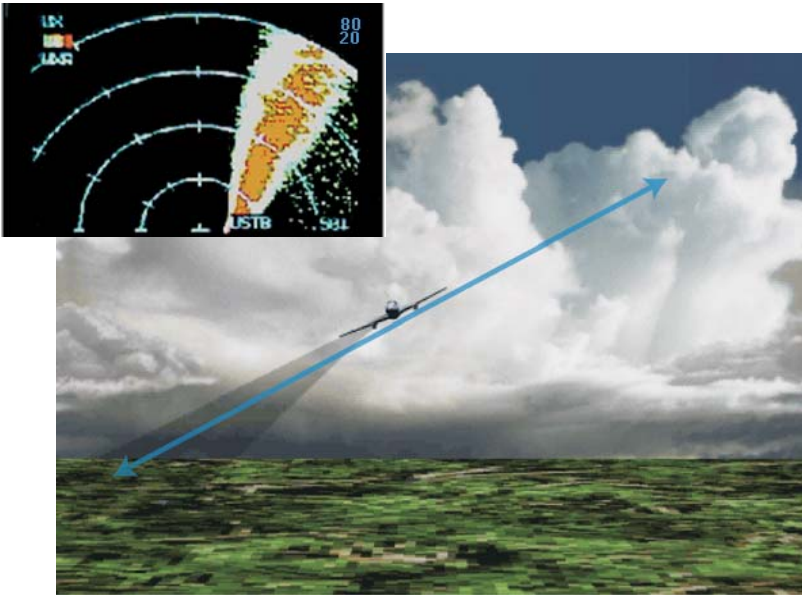

TPG3130\_77

If a combination of antenna tilt, aircraft roll, and aircraft pitch exceeds 45°, then the stabilization stays at the 45° limit. As the total decreases below the 45° limit, normal stabilization operation resumes.

## ***RADAR BEAM CHARACTERISTICS***

The MultiScan radar uses a 28-inch antenna that produces a 3.5°-wide beam. As the beam sweeps through a thunderstorm at close range, it takes a “slice” out of the target and then displays that slice on the radar display (figure 6-20). The displayed weather presentation can change significantly based on the selected radar tilt and from where in the storm the slice is taken from (♦page 5-7).

*Figure 6-20 Weather Radar Beam “Slice” and Resulting Display*

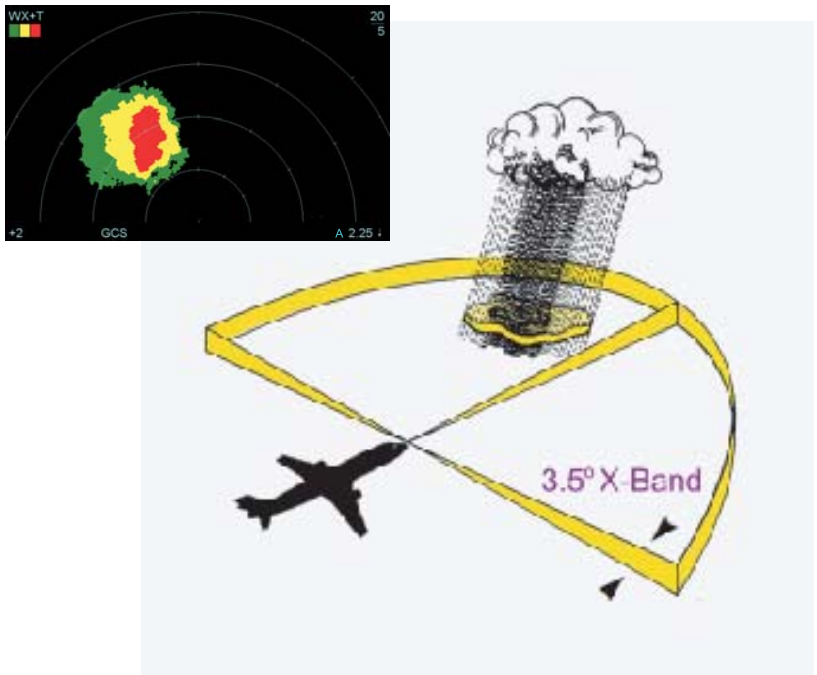

TPF9615\_75

## BEAM DIAMETER

A 28-inch flat-plate antenna produces a 3.5°-wide beam. At ranges less than 80 NM, this produces a fairly narrow and well-focused beam. Beyond 80 NM, the beam diameter increases until at 300 NM it is equal to 105,000 feet (figure 6-21). To put this into perspective, at this distance, it would take a storm cell over 22 NM tall and wide to fill the beam.

Because the beam remains fairly focused within 80 NM of the aircraft (and for reasons that will be mentioned in the next section), it is recommended that weather evaluation be done only when the weather is within 80 NM of the aircraft. Beyond 80 NM, the radar should be used primarily for strategic planning and weather avoidance.

The following formula can be used to calculate the approximate beam width at any range:

$$\text{Beam width (in feet)} = (\text{Distance in NM} + "00") \times 3.5$$

For example, to determine the width of the radar beam at 50 NM out from the aircraft, take the 50 NM distance and then add "00" to it for a result of 5,000. Multiply this figure by 3.5 to yield an approximate beam width of 17,500 feet at 50 NM.

Figure 6-21 Weather Radar Beam Width Increases Over Distance

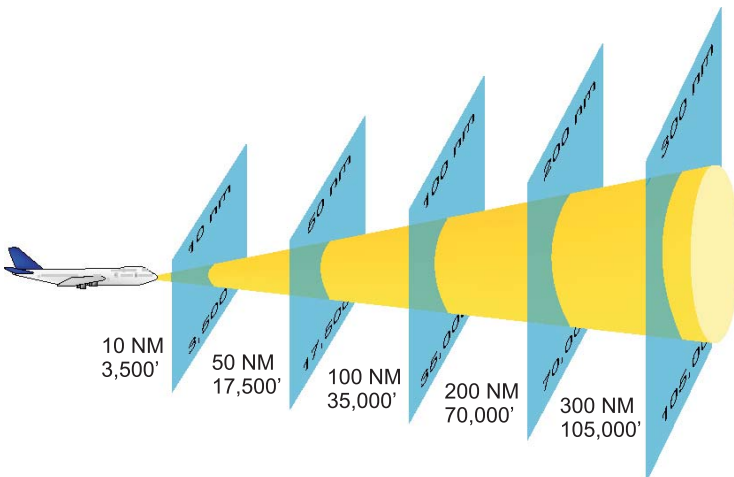

TPG3130\_78



## ***RANGE AND AZIMUTH RESOLUTION***

Range and azimuth resolution are affected by the length of the pulse width and the width of the radar beam, respectively. For long-range weather detection, the radar uses a longer pulse width to put more energy on the target. The longer pulse can cause targets to merge into a single target due to the fact that the front of the pulse may already be in contact with the next target before the trailing edge of the pulse leaves the previous target (see figure 6-22). Thus, the pulse appears to be painting one continuous target. Shorter pulse widths are used for close range targets and are thus able to distinguish more precisely between the different weather targets. Often on the display, this is manifested by more “blocky”-looking weather at extended ranges and a more refined weather picture at shorter ranges.

Figure 6-22 Range Resolution versus Azimuth Resolution

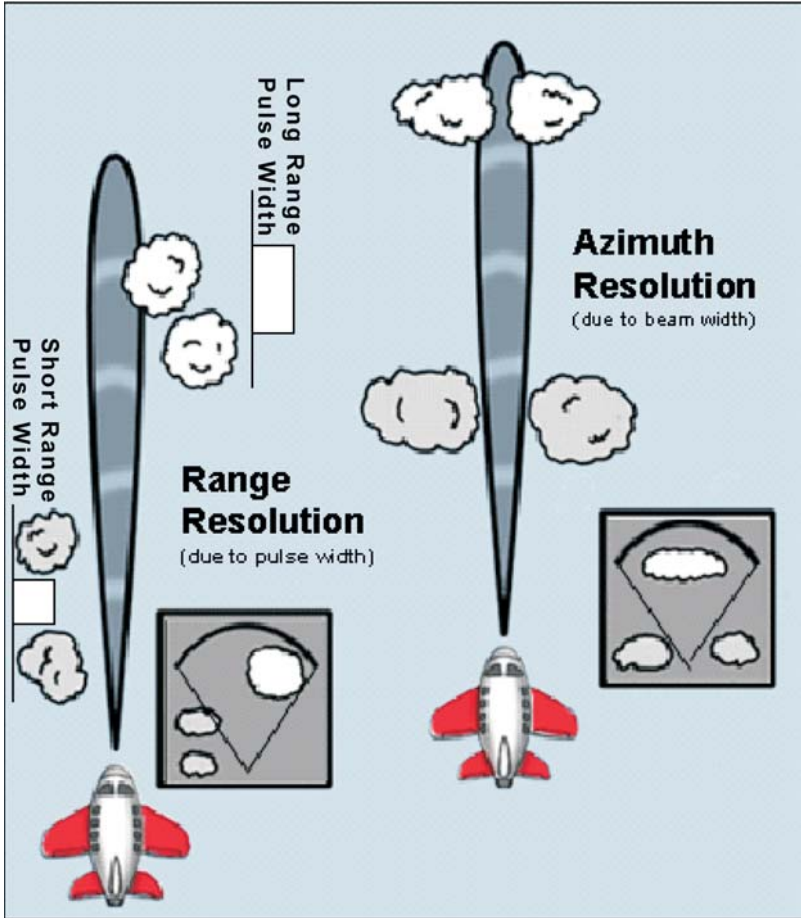

TPF9615\_67

In a similar manner, long-range weather targets can be merged into a single target due to the large beam width diameter at extended ranges. In this case, the leading edge of the beam comes in contact with a new target before the trailing edge of the beam leaves the previous target (see figure 6-29). As the aircraft nears the weather targets, the beam narrows and the leading edge of the beam will not contact the next target until the trailing edge has left the previous target. Thus it is not unusual to see a storm cell separate into two cells as it nears the aircraft and the beam becomes narrow enough to distinguish between them.

## **BEAM ATTENUATION**

Significant attenuation of the radar signal due to absorption and scattering occurs as the transmitted pulse moves to its furthest range and again during transit back to the receiver from a radar target. In addition, beyond 80 NM a normal thunderstorm (defined as a 3-NM sphere of water) no longer fills the radar beam. As a consequence, significant amounts of radar energy bypass the target entirely (figure 6-23). The end result is that, for weather targets detected at extended ranges, the signal received back at the aircraft is significantly weaker than the original radar pulse. In the case of previous generation radars, the effects of attenuation were visible as a distant thunderstorm approached the aircraft. The storm would tend to be green at longer ranges but steadily grow in intensity until it turned red close into the aircraft (see figure 6-24).

*Figure 6-23 Radar Beam Attenuation*

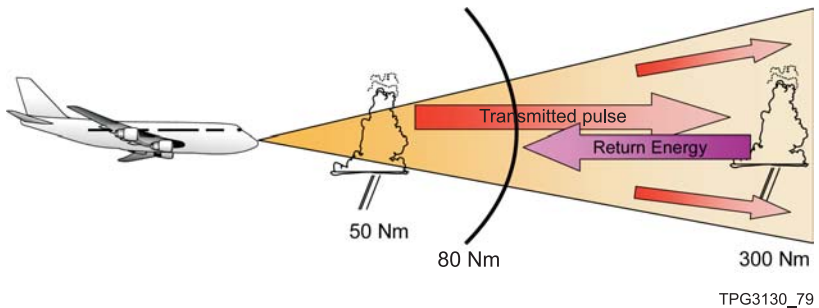
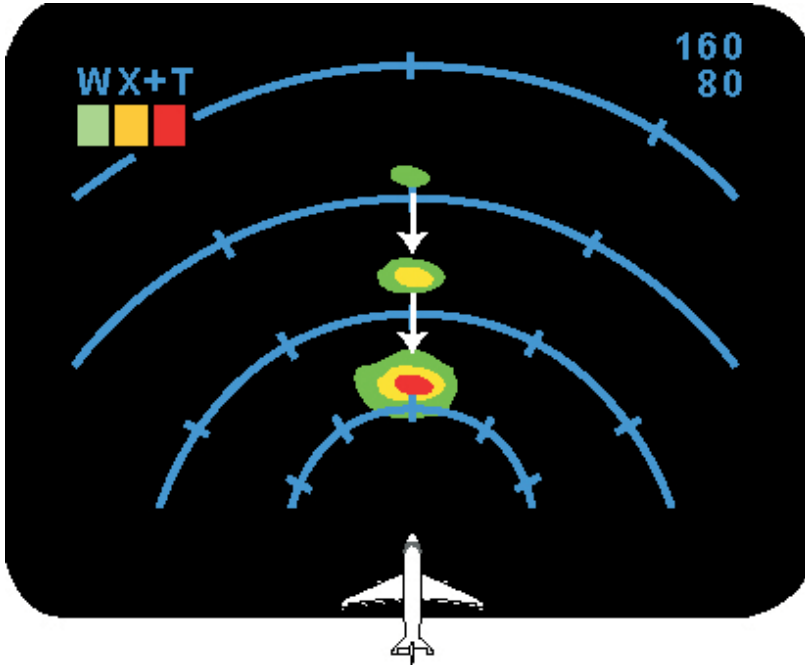

Figure 6-24 Effects of Radar Beam Attenuation on the Radar Display



TPG3130\_80

### **SENSITIVITY TIME CONTROL (STC)**

Sensitivity Time Control (STC) is designed to compensate for beam attenuation within 80 NM of the aircraft. Essentially, STC increases receiver sensitivity over time (see figure 6-25) so that more distant thunderstorm cells have more energy on the target than do cells closer to the aircraft. In the past, if two identical cells were seen by radar at different ranges, the closer cell would appear more intense than the more distant cell due to attenuation (♦page 6-23). However, STC allows the radar to compensate for attenuation and accurately see and display more distant targets. The end result is that targets within 80 NM of the aircraft should be displayed accurately (accurate color levels) and target intensity should not increase as the aircraft approaches the cell (figure 6-26) unless the cell is actually a building thunderstorm and is growing in intensity (see figures 6-27).

Figure 6-25 Receiver Sensitivity versus Target Distance

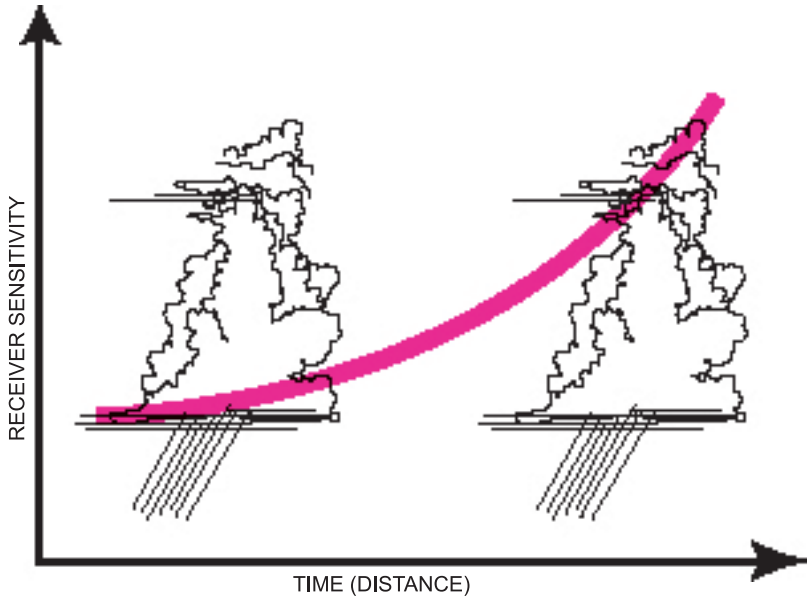

TPG3130\_81

Figure 6-26 STC Weather Compensation for Two Identical Cells

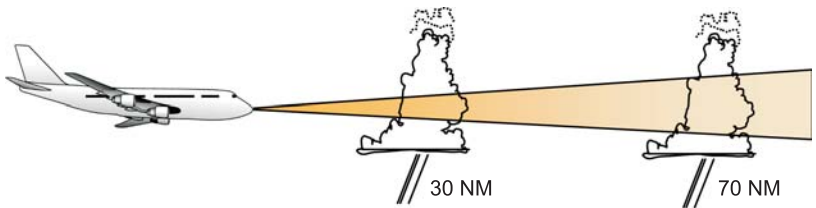

TPG3130\_82

Figure 6-27 STC Weather Radar Display Compensation

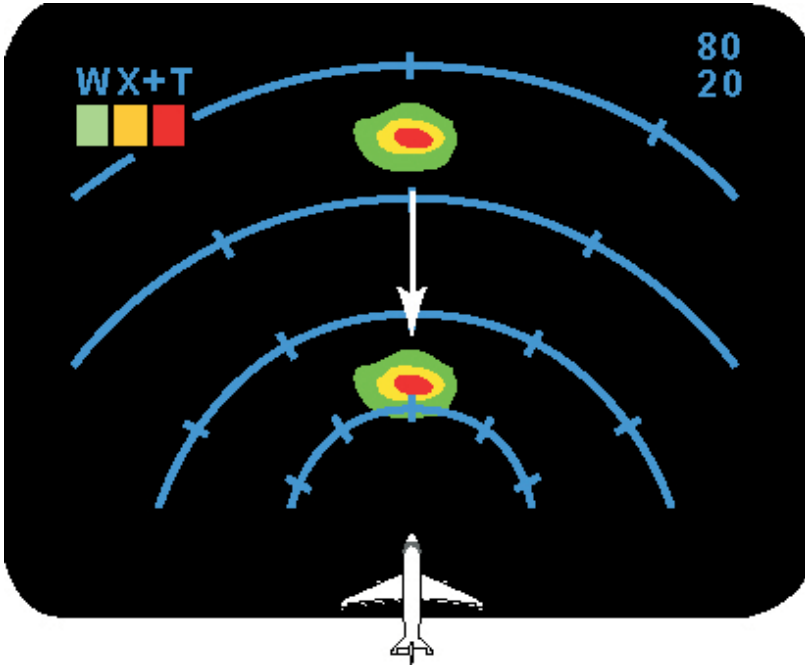

TPG3130\_83

Sensitivity Time Control provides highly accurate weather returns within 80 NM of the aircraft. For this reason, and reasons explained earlier (♦page 6-23), it is recommended that only weather targets within 80 NM of the aircraft be evaluated for possible threats to the aircraft. For weather targets that appear at ranges beyond 80 NM, the radar should be used primarily for strategic weather planning.

### **LONG-RANGE COLOR ENHANCEMENT**

Long Range Color Enhancement compensates for beam attenuation for ranges from 80 to 320 NM. Essentially, Long Range Color Enhancement estimates the amount of attenuation that has occurred and adjusts the color levels to compensate. For instance, a thunderstorm detected at 300 NM will appear green due to the amount of attenuation that occurs at extended ranges. However, a cell detected at this range has significant vertical development and a red core. Therefore, Long Range Color Enhancement changes the return to red. However, a red return

by itself would not look like a traditional weather return, so Long Range Color Enhancement also adds a yellow and green border within the return to more closely emulate normal weather colors. For this reason, weather detected at long ranges will tend to grow as it approaches the aircraft because there is less attenuation and the radar beam is able to more clearly detect the true color levels and size of the storm.

*Figure 6-28 Long Range Color Enhancement Display*

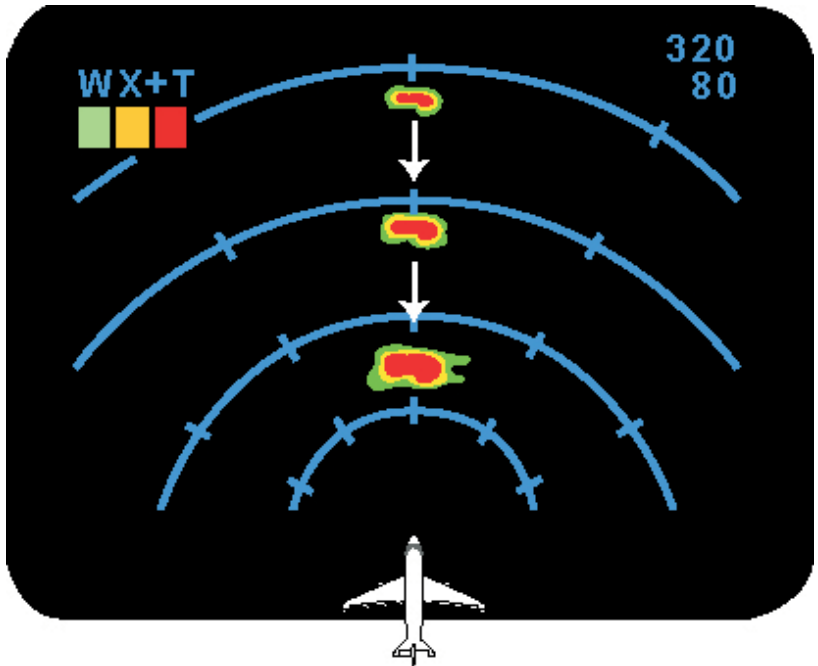

TPG3130\_84

### ***PATH ATTENUATION (RADAR SHADOW)***

When intervening rainfall becomes heavy the radar beam may be so severely attenuated that there is not enough energy to penetrate the weather, see what is behind, and then return to the aircraft (see figure 6-29). When this situation occurs, weather behind the intervening rainfall will be masked. This area of hidden weather is often referred to as an area of radar shadow.

Several characteristics of the displayed weather may give clues to attenuated areas. In figure 6-29, the display shows a normal green, yellow and red pattern on the front side of the thunderstorm. However, the backside of the storm shows red and yellow and no green. The concave shape on the back of the storm also points to a possible area of severe attenuation. Finally, the absence of ground clutter behind the cell is a third indication that the area behind this cell may be an area of radar shadow.

In order to evaluate the area behind the storm, lower the tilt until significant ground clutter appears on the display. If there is clutter to the right and left sides of the thunderstorm, but the area behind the cell remains black, then the radar beam has experienced severe attenuation in this region and a radar shadow exists.

Figure 6-29 Weather Display with Radar Shadow

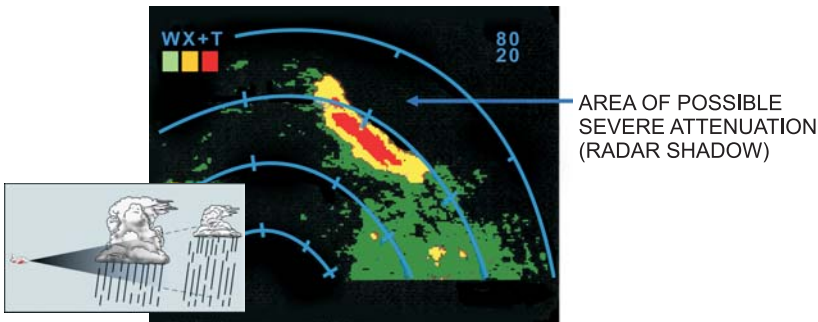

TPG3130\_85

The following picture sequence (figure 6-30) shows an aircraft penetration of a line of thunderstorms that is causing radar attenuation. The aircraft is approaching a line of thunderstorms. Although it is not readily apparent, attenuation is masking weather in the top left hand area of the display (top left image). As the aircraft penetrates the storm front, attenuation increases. Storms to the left disappear and storms in the upper right hand area of the display are diminished (top right image). Mid way through penetration of the initial storm cell a small weather return becomes visible in the center of the display (middle left image). As the aircraft nears the trailing edge of the initial storm cell, several additional returns become visible (middle right image). At the trailing edge of the initial cell, the new returns form a new thunderstorm line (bottom left image). After exiting the first line of thunderstorms, the



true extent of the previously attenuated weather is apparent (bottom right image).

Figure 6-30 Radar Displays of Penetration of Thunderstorm

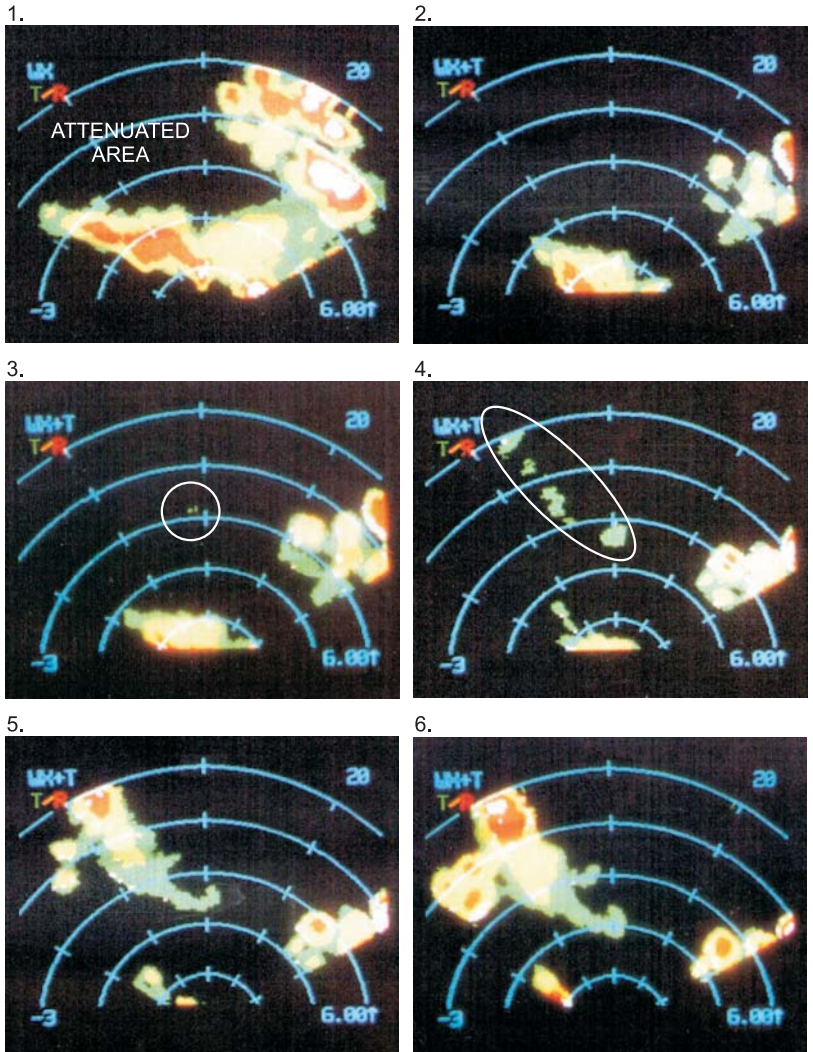

TPG3130\_86

## ***RADOME CHARACTERISTICS***

The radome is an integral part of the radar system and serves as the radar's "window" to the outside world. Repeated painting, repairs or cracks that allow water into the radome honeycomb structure can significantly lessen the radome's transmittivity and create extensive side lobes.

### ***CAT'S EYES/GHOST TARGETS***

"Cats' Eyes" or "Ghost Targets" may appear in a narrow green or green yellow arc or as two small targets at +/- 45°. They normally occur between the 4 and 8 mile ranges and when the aircraft altitude is above approximately 3,000 feet. Cats' Eyes are ground returns that result from side lobe or main lobe reflections. The distance to the return will be the same as the aircraft altitude. It is not uncommon to see Cat's Eyes when MAX gain is selected, even with new radomes. However, they should not be visible in the **CAL** (calibrated) gain position. If Cat's Eyes are visible during **CAL** gain operation, it is an indication that repeated painting and/or patching has significantly reduced radome transmittivity.



#### **NOTE**

Because Cat's Eyes are a result of ground returns, they are not visible when the aircraft is on the ground.

Figure 6-31 Cat's Eyes Returns on Radar

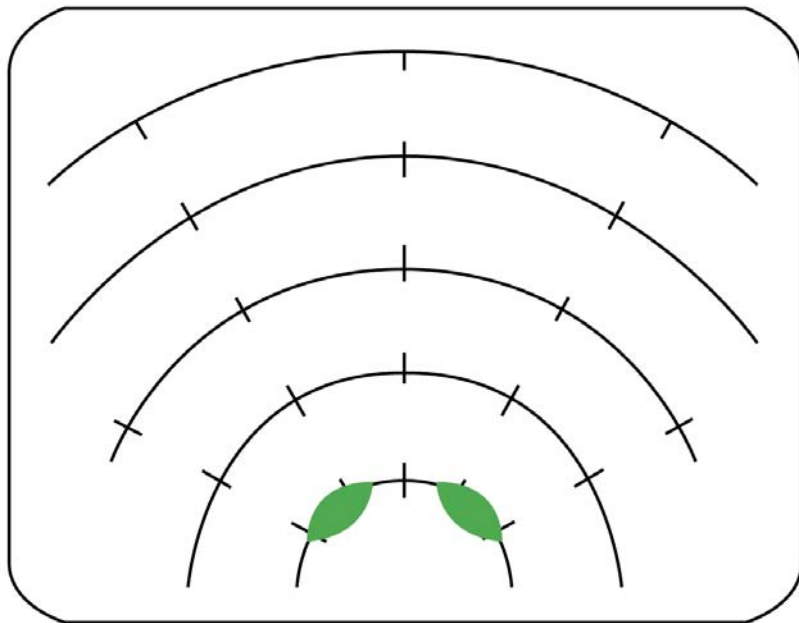

TPG3130\_89

## **RADOME INSPECTION**

Water can get trapped in the radome honeycomb structure due to small cracks in the outer skin. Water that accumulates in various parts of the honeycomb structure can greatly decrease transmissivity. Two methods can be used to check for the existence of water in the radome:

1. Shine a flashlight through the front of the radome. A second person behind the radome can identify water trapped in the radome honeycombs.
2. A Q-meter can be used to check for moisture in the radome.

A general knowledge of the radome's transmissivity can be ascertained by inspecting maintenance records to:

1. Ensure excessive patching or repairs have not occurred.
2. Ensure radome has not been subject to repeated painting and has been painted with non-lead based paint.



**NOTE**

A windshear radome that has had numerous repairs or had several coats of paint should be tested at a qualified radome repair facility in order to ensure the radome meets windshear Class C radome requirements.

## ***DOPPLER TURBULENCE***

Doppler turbulence detection is designed to detect water droplet horizontal velocities of 5 meters/second (m/s) or greater. However, water droplet velocity alone does not necessarily indicate an area of turbulence. Of more importance is the “spectrum” of velocities. In other words, turbulence is indicated not only by the velocity of the water droplets but also by how much the water droplets vary in velocity.

In figure 6-32, target A contains several droplets with velocities of 5 m/s or greater. However, the variance in the velocities is not pronounced and the radar does not consider this target as turbulent. Target B, on the other hand, contains droplets with velocities equal to or greater to 5 m/s plus a wide spectrum of velocities and would be considered turbulent.

Figure 6-32 Non-Turbulent versus Turbulent Targets

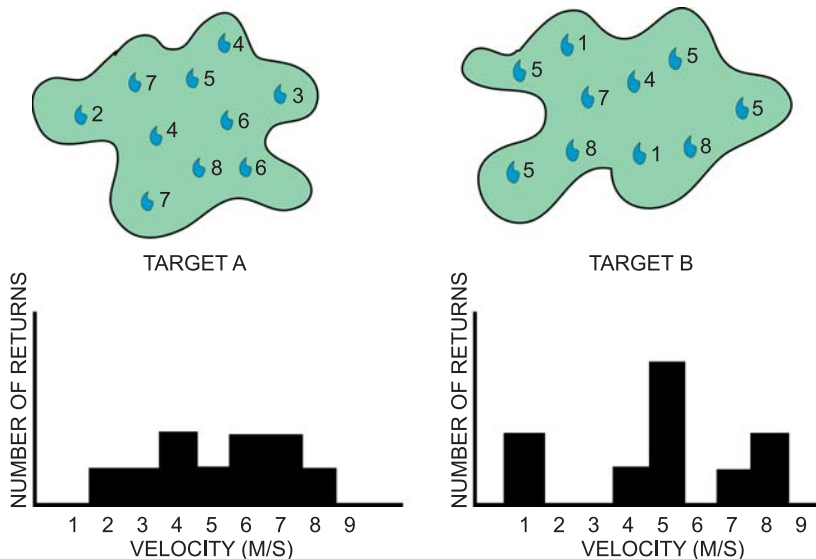

TPF9615\_86

## WINDSHEAR

### WINDSHEAR EVENT

A windshear event, such as a microburst, is a condition in which the wind abruptly changes its speed or direction (or both) over a small distance (♦page 5-22, ♦page 5-26). It can be associated with frontal systems occurring over a large area, or with thunderstorms occurring over a small area. Windshear can occur at altitude without the presence of clouds, referred to as clear air turbulence, or near ground level where it has an impact on the takeoffs and landings of aircraft. It is a specific type of windshear occurring near the ground, referred to as a down burst, that presents the greatest danger to aircraft.

A down burst can be detected by a Doppler weather radar. This is possible because of the atmospheric moisture content associated with these events. The echo returns are analyzed for characteristic velocity and direction patterns called signatures. The “velocity signature” of a

down burst is defined as an area of positive and negative velocities existing over a short distance.

During a down burst, strong head winds of the event will produce a positive Doppler frequency shift, while the strong tail winds will produce a negative Doppler frequency shift. The distance between these two events is determined by the amount of elapsed time between the respective echo returns. If the velocity signature meets the minimum criteria, aural and visual alerts are provided to the flight crew (♦page 4-50) .

The velocity gradient is used to establish a hazard factor. The hazard factor used to define a windshear event is defined by NASA and is shown in figure 6-33.

Figure 6-33 NASA Hazard Factor for Windshear

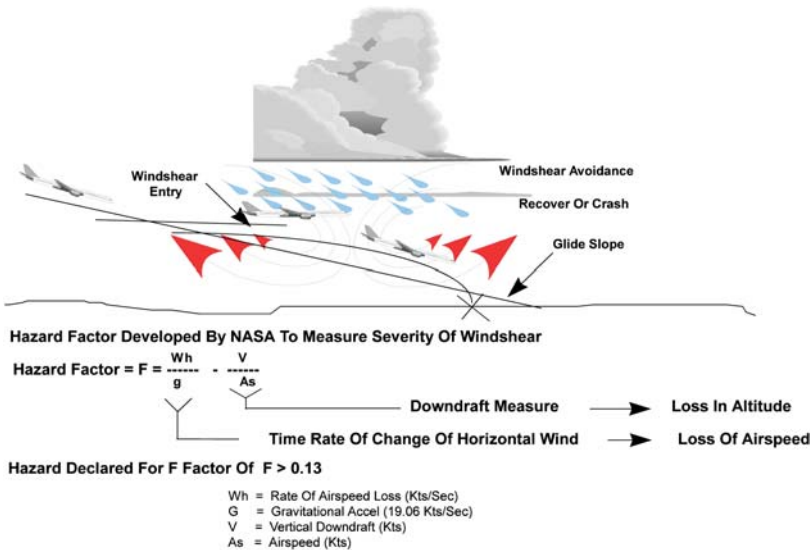

TPG3130\_90

The term V/As represents down draft. The velocity of the down draft (V) is by definition negative. Therefore, - V/As is a positive number and is added to Wh/g to provide the hazard factor.

In figure 6-33, the hazard factor is the total of the time rate of change of the horizontal wind (Wh/g) and the down draft measure (V/As). By setting V/As = 0 we can determine the time rate of change of the

horizontal wind that would be required for a hazard factor of 0.13:

$$F = 0.13 = Wh/g + V/As$$

$$\text{Set } V/As = 0$$

$$\text{Then } F = 0.13 = Wh/19.06 \text{ kts/sec}$$

$$\text{Solving for } Wh = 2.47 \text{ knots/sec}$$

Thus, if the down draft is equal to zero, it would require a 2.47 knots/sec rate of change of the horizontal wind to activate the cockpit windshear alerts.

Likewise, if we set rate of change of the horizontal wind (Wh/g) equal to zero and assume an approach airspeed of 150 knots, then we can calculate the down draft that is required to activate the cockpit windshear alerts:

$$F = 0.13 = Wh/g + V/As$$

$$\text{Set } Wh/g = 0$$

$$\text{Then } F = 0.13 = V/150 \text{ knots}$$

Thus, if the rate of change of the horizontal wind is equal to zero and the aircraft approach speed is 150 knots, then it would require a 19.5 knot down draft to activate the cockpit windshear alerts.

An actual windshear event will contain both horizontal and vertical hazards.

## ***AUTOMATIC ENABLE***

Windshear alerts are active in the cockpit below 1,200 feet AGL. However, the WXR-2100 radar actually enters the windshear scanning mode at 2,300 feet AGL to provide time for the system to power up (if necessary) and update the displays before the aircraft reaches the 1,200 feet AGL level. During windshear scan, the radar automatically reduces the sweep of the antenna to a 120° (+/- 60°) area directly ahead of the aircraft (♦page 4-45). This feature provides an increase in the system update rate to the display during the takeoff and landing phases of flight. The weather display is updated once every 6 seconds (as opposed to once every 8 seconds) as the weather scans are alternated with the windshear scans. This implementation provides rapid weather updates and also allows the radar to continually display weather behind the windshear icon.

Windshear detection scanning is automatically activated when the radio altimeter reports an altitude less than 2,300 feet and the aircraft is on the runway or in the air (not in the maintenance hanger). Automatic

activation occurs even if the radar is turned off in order to provide detection and warning of microburst events during the landing and take off phases of flight. If a windshear hazard is detected, the radar issues either an Advisory, a Caution, or a Warning (♦page 4-50) to the flight crew through visual and aural indications. If the radar has automatically enabled and a display mode has not been selected (the display is OFF), the aural alerts and cockpit annunciators will still be operational. In this case the crew will be notified of a Caution or Warning. Advisory detection will not be present as this is a display-only alert.

Windshear icons are displayed in either the Weather (WX) or Weather Plus Turbulence (WX+T) display modes. If the radar is on, but in MAP or TEST mode and the system detects a windshear hazard event, the system display will automatically change to the WX+T mode to display weather and windshear icons. The selected range does not change automatically.

During the windshear scan (below 2,300 feet AGL), the antenna tilt position is automatically controlled to optimize system windshear detection performance.

## ***COLLINS' WINDSHEAR PHILOSOPHY***

Collins' windshear coverage is designed to provide an alert to potentially hazardous microburst in the landing and take off environment. Collins' windshear philosophy attempts to provide the best balance between desired windshear alert coverage and unnecessary windshear detections.

The Collins' windshear coverage philosophy can best be understood by examining the Albany ILS approach (figure 6-34). Note the following:

1. The approach has a three degree glide slope (i.e., a normal ILS approach).
2. The approach is a normal straight in approach from the initial approach fix (IAF).
3. The aircraft intercepts the ILS glide slope at 2,215 feet AGL.
4. The initial approach fix (IAF) is 7 NM from touchdown.
5. Windshear indications are made available to the flight crew when the aircraft passes through 1,200 feet AGL. On a standard ILS approach, such as this one, this occurs 4.3 NM from touchdown.



Figure 6-34 ILS Rwy 1 Approach, Albany NY

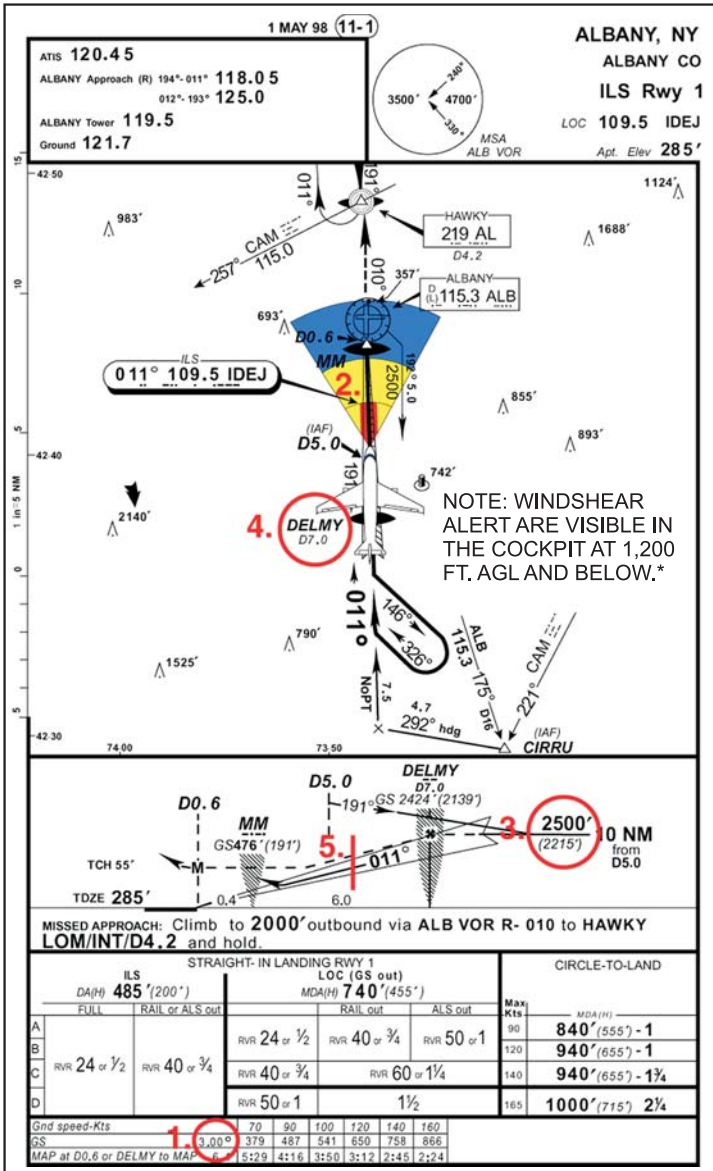

TPG3130\_91

Figure 6-35 provides a more detailed look at the coverage area at the moment the aircraft passes through 1,200 feet and windshear alerts are activated in the cockpit. The windshear detection region is to scale. Note that the windshear detection region fully encompasses the runway touchdown zone.

When windshear alerts are activated in the cockpit (passing 1,200 feet AGL) the runway touchdown zone is fully encompassed by the windshear detection region.

Figure 6-35 Windshear Coverage From IAF, ILS Rwy 1 Approach

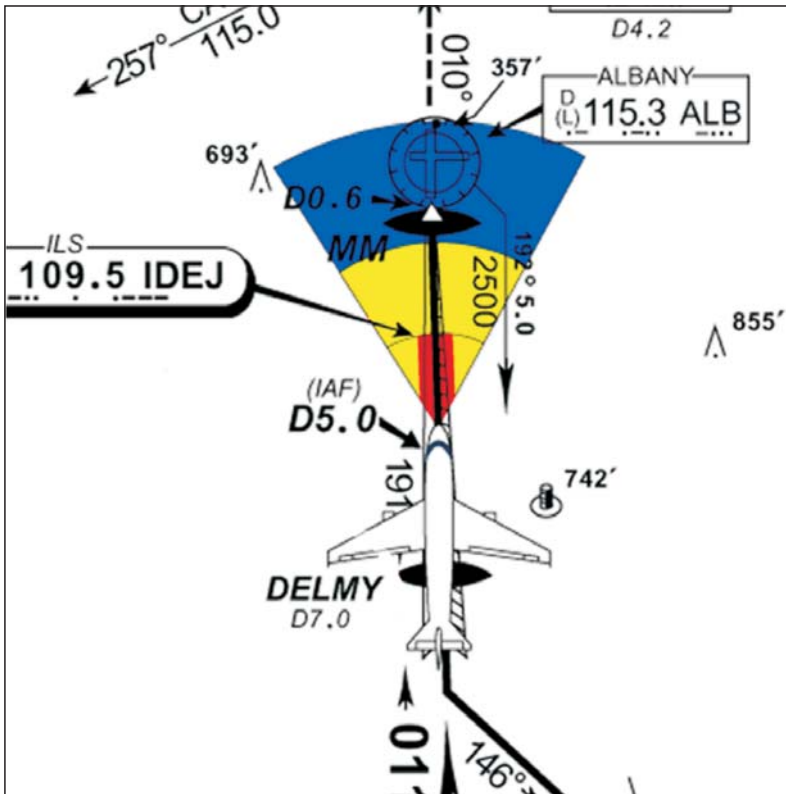

TPG3130\_92

Figure 6-36 demonstrates windshear coverage in a crosswind situation. The wind is from the east. The windshear detection region continues to fully encompass the runway touchdown zone. Note that a windshear



## **AIRBUS**

Airbus alert activation regions for takeoff: Warnings, Cautions and Advisories are enabled from the beginning of the takeoff roll (0 knots) until the aircraft passes 1,200 feet. All alerts are disabled from the time the aircraft passes 100 knots until it reaches 50 feet.

*Figure 6-37 Airbus Windshear Alert Activation Region for Takeoff*

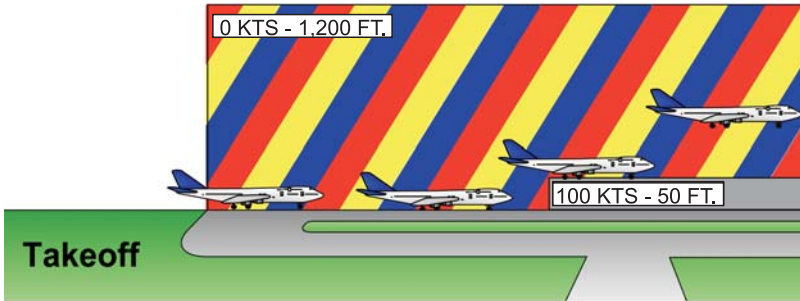

TPG3130\_94

Airbus alert activation regions for landing: Warning, Cautions and Advisories are enabled from the time the aircraft descends through 1,200 feet until it passes through 50 feet. From 50 feet until touchdown, all alerts are disabled.

Figure 6-38 Airbus Windshear Alert Activation Region for Landing

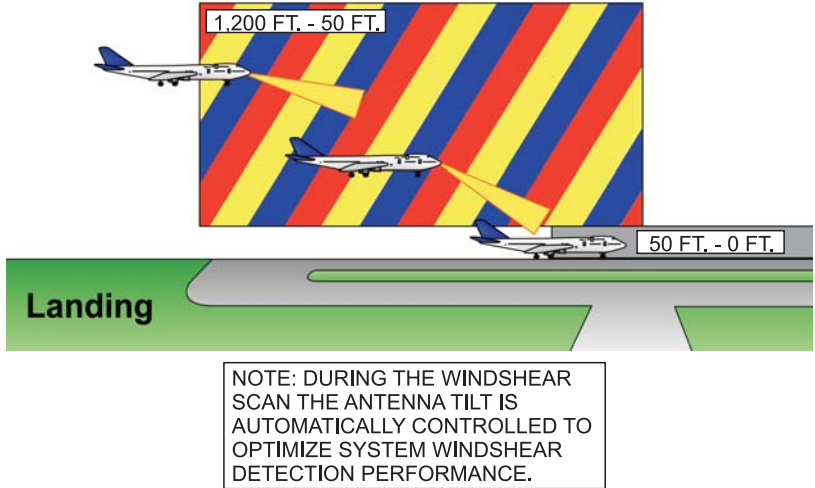

TPG3130\_95

## **BOEING**

Boeing alert activation regions for takeoff: Warnings and Cautions are enabled from the beginning of the take off roll (0 knots) until the aircraft reaches 80 knots. From 80 knots until the aircraft passes 400 feet, only Warnings are enabled. From 400 feet through 1,200 feet, Warnings and Cautions are enabled. All alerts are disabled from the time the aircraft passes 100 knots until it reaches 50 feet. Boeing aircraft do not display Advisories (♦page 4-48).

*Figure 6-39 Boeing Windshear Alert Activation Region for Takeoff*

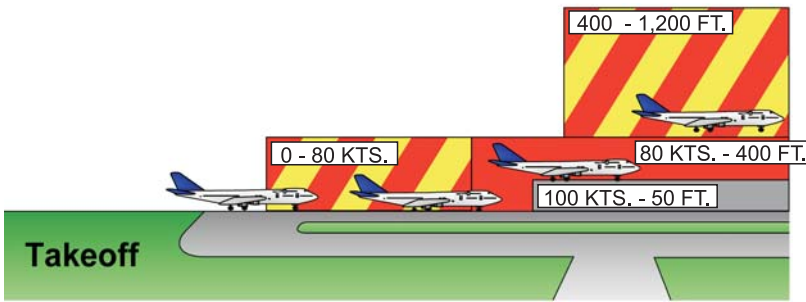

TPG3130\_96

Boeing alert activation regions for landing: Warnings and Cautions are enabled from the time the aircraft passes 1,200 feet until 400 feet. From 400 feet until 50 feet, only Warnings are enabled. From 50 feet until touchdown (0 feet), all alerts are disabled. Boeing aircraft do not display Advisories (♦page 4-48).

Figure 6-40 Boeing Windshear Alert Activation Region for Landing

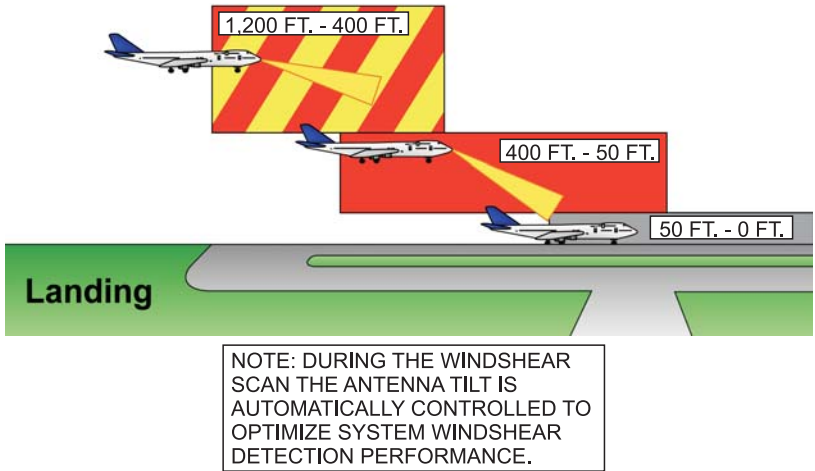

TPG3130\_97

## **MVD™ WINDSHEAR RECORDING**

MVD™ is a data recording system inside the WXR-2100 R/T that automatically stores windshear Magnitude, Velocity, and Deviation information. These three key pieces of windshear information allow detailed engineering analysis of windshear events. The radar is able to store up to three events of twelve sweeps each. If further analysis of a windshear event is required the information can be down loaded with a lap top computer.

## ALIEN RADAR

The WXR-2100 radar incorporates a sophisticated alien radar rejection algorithm that is designed to prevent interference from other airborne weather radars. However, high power military radars and military radar-jamming systems will “burn through” and cause display artifacts. Figure 6-43 shows a typical interference pattern caused by a high powered military radar.

Figure 6-41 Interference Pattern From Military Radar-Jamming System on Radar Display

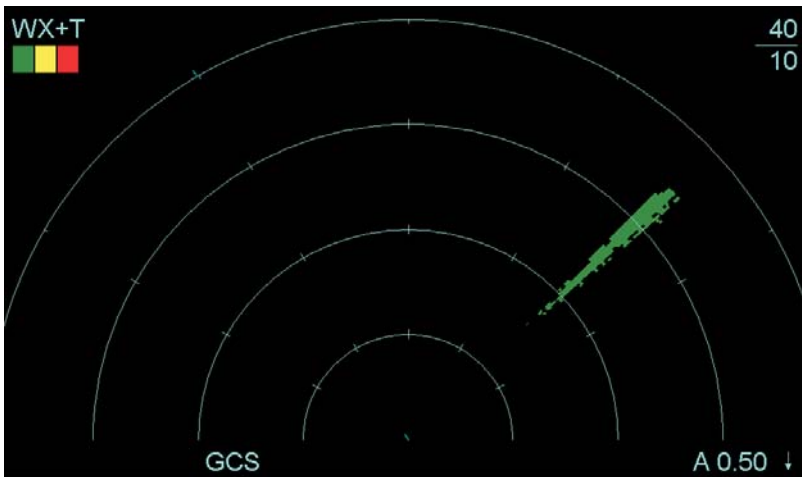

TPG3130\_98

## RADIATION HAZARDS

To provide a practical safety factor, the American National Standards Institute has specified a maximum level of 10 mw/cm<sup>2</sup> for personnel exposure of 6 minutes or longer to radar antenna electromagnetic radiation. The exposure time is limited to the amount of time **within the antenna pattern** during each sweep.

In 1980, Collins engineering personnel measured the radiation emissions of an actual weather radar system on the flight line. A General Microwave radiation hazard meter (Model 481B) was used to measure the emitted radiation. It was placed 1.5 feet in front of the radar's flat-plate antenna during normal operation with the radome



removed. System range was set to 320 NM to provide the maximum pulse width. Under these conditions, the maximum power density meter reading was 0.3 mw/cm<sup>2</sup>.

In a similar fashion, the United States Air Force's Armstrong Laboratory measured the power density of the military version of the windshear radar and found the highest power density level to be 0.13 mw/cm<sup>2</sup>.

The Collins WXR-2100 radar system falls well below the 10 mw/cm<sup>2</sup> standard. However, it should be noted that there is some disagreement that the 10 mw/cm<sup>2</sup> standard is low enough. Microwave ovens represent a more public safety concern and their leakage standard has been set at 4 mw/cm<sup>2</sup>. The WXR-2100 power density is half or less than that of the microwave oven standard.



**NOTE**

Some sources suggest that any radiation exposure can be harmful, especially long term. Each airline must make their own decision on this, as exposure to radiation is occasionally cited by an employee as a cause of some physical injury.



**NOTE**

For specific requirements and limitations, refer to FAA Advisory Circular 20-68B, "Recommended Radiation Safety Precautions for Ground Operation of Airborne Weather Radar."

This page intentionally left blank

## **GLOSSARY**

---

### **Decibel**

A decibel is a logarithmic expression of the ratio between two power levels.  $dB = 10\log(P1/P2)$  (e.g., the ratio 200/10 expressed in dB is  $10\log(200/10) = 13dB$ )

### **X-Band**

The operating frequency range of a receiver transmitter. The x-band frequency is 9300 MHz.

### **Z**

The Radar Reflectivity Factor Z is a measure of the strength of the radar echo from a unit of volume containing precipitation. Z is related to the number and size of rain drops within a given volume, hence more rain drops or larger rain drops within a given volume will result in a higher radar reflectivity value for Z.

For airborne radars, Z is commonly related to rainfall rate by the following equation:

$Z=200*r^{1.6}$  where r is the rainfall rate in millimeters per hour

This page intentionally left blank

# INDEX

Subject	Page
<b>A</b>	
Airbus windshear alert activation regions .....	6-40
Airbus, control panel .....	4-1
Airbus, display annunciations .....	4-4
Airbus, gain settings .....	6-6
Airbus, predictive windshear .....	4-52
Airbus, TEST .....	4-52
Airbus, windshear coverage .....	4-46
Alerts, ADVISORY .....	4-51
Alerts, CAUTION .....	4-51
Alerts, WARNING .....	4-50
Alerts, windshear .....	4-50
Alien radar .....	6-44
Antenna, calibration .....	6-16
Antenna, characteristics .....	6-12
Antenna, flat-plate .....	6-12
Antenna, parabolic .....	6-12
Antenna, side lobes .....	6-14
Antenna, stabilization .....	6-17
Attenuation of radar beam .....	6-23
Automatic enable .....	6-35
Automatic gain .....	3-8
Automatic operation .....	4-12
Automatic operation, controls .....	4-13
Azimuth resolution .....	6-21
<b>B</b>	
Boeing windshear alert activation regions .....	6-42
Boeing, control panel .....	4-2
Boeing, display annunciations .....	4-7
Boeing, gain settings .....	6-7
Boeing, TEST .....	4-53
Boeing, TEST display .....	4-55
Boeing, transfer .....	4-20
Boeing, windshear coverage .....	4-48
Bright band, reflectivity .....	5-4

Subject	Page
---------	------

**C**

Calibrated gain .....	4-35, 6-4
Calibration, antenna .....	6-16
Cat's eyes .....	6-30
Characteristics, antenna .....	6-12
Characteristics, radar beam .....	6-19
Characteristics, radome .....	6-30
Characteristics, thunderstorms .....	5-14
Collins windshear philosophy .....	6-36
Color scheme, calibrated gain .....	6-4
Control panel, Airbus .....	4-1
Control panel, Boeing .....	4-2
Controls, automatic operation .....	4-13
Controls, gain .....	4-43
Controls, ground clutter .....	4-16, 4-60
Controls, manual operation .....	4-58
Controls, power .....	4-12
Controls, tilt .....	4-17, 4-61

**D**

Detection, weather .....	4-22
Detection, windshear .....	4-45
Diameter of radar beam .....	6-20
Display annunciations, Airbus .....	4-4
Display annunciations, Boeing .....	4-7
Display annunciations, retrofit aircraft .....	4-9
Doppler turbulence detection .....	6-32
Dual system selection .....	4-18

**E**

Effects of gain selection .....	6-8
Emulation of ideal radar beam .....	3-5

**F**

False windshear warnings .....	6-14
Features, MultiScan .....	2-1
Flat-plate antenna .....	6-12
Frequency comparison .....	6-2

Subject	Page
<b>G</b>	
Gain .....	4-82, 6-4
Gain control, settings .....	6-5
Gain PLUS™ .....	4-35
Gain selection, effects .....	6-8
Gain settings, Airbus .....	6-6
Gain settings, Boeing .....	6-7
Gain, automatic .....	3-8
Gain, calibrated .....	4-35
Gain, controls .....	4-43
Gain, variable temperature-based .....	4-38
GCS .....	4-16
Ghost targets .....	6-30
Ground Clutter Suppression (GCS) .....	4-16
Ground clutter, controls .....	4-16, 4-60
Gust front .....	5-14
 <b>H</b>	
Hazardous weather, introduction .....	5-31
Hazardous weather, irregular shapes .....	5-34
Hazardous weather, steep gradient .....	5-33
 <b>I</b>	
Ideal radar beam .....	3-4
Inspection, radome .....	6-31
Irregular shapes, weather .....	5-34
 <b>K</b>	
Key operating features .....	2-1
 <b>L</b>	
Long range color enhancement .....	6-26
Low altitude operation .....	4-23
 <b>M</b>	
Manual operation .....	4-57
Manual operation, controls .....	4-58
MAP .....	4-33
Map mode (MAP) .....	4-33

Subject	Page
Microbursts .....	5-22
Mode, MAP .....	4-33
Mode, TEST .....	4-52
Mode, TURB .....	4-31
Mode, WX .....	4-27
Mode, WX+T .....	4-28
MultiScan process .....	3-6
MultiScan, features .....	2-1
MVD™ Windshear recording .....	6-43

## **N**

Non-reflective weather .....	5-37
------------------------------	------

## **O**

Oceanic Weather Reflectivity Compensation™ .....	4-43
Oceanic, weather cells .....	5-16
Over-scan, prevention .....	4-72
OverFlight protection .....	4-40

## **P**

PAC Alert .....	4-39
Parabolic antenna .....	6-12
Path attenuation .....	6-27
Path attenuation compensation (PAC) Alert .....	4-39
Power, controls .....	4-12
Predictive windshear, Airbus .....	4-52
Prevention, over-scan .....	4-72
PWS .....	4-52

## **R**

Radar beam, attenuation .....	6-23
Radar beam, characteristics .....	6-19
Radar beam, diameter .....	6-20
Radar beam, emulation of ideal .....	3-5
Radar beam, ideal .....	3-4
Radar beam, range and azimuth resolution .....	6-21
Radar shadow .....	6-27
Radar system .....	6-1
Radar top, thunderstorm .....	4-76



Subject	Page
Radiation Hazards .....	6-44
Radome, characteristics .....	6-30
Radome, inspection .....	6-31
Range resolution .....	6-21
Receiver sensitivity .....	4-35
Reflectivity .....	5-1
Reflectivity, bright band .....	5-4
Reflectivity, thunderstorm .....	3-1, 5-5
Reflectivity, water molecule .....	5-1
Retrofit aircraft, display annunciations .....	4-9
Retrofit aircraft, windshear coverage .....	4-46

## S

Sensitivity time control .....	6-24
Sensitivity, receiver .....	4-35
Settings, climb tilt .....	4-64
Settings, descent tilt .....	4-66
Settings, gain control .....	6-5
Settings, high altitude tilt .....	4-70
Settings, mid altitude tilt .....	4-69
Settings, over water tilt .....	4-72
Settings, tilt .....	4-63
Side lobes, antenna .....	6-14
Split function control panel .....	4-2
Squall lines .....	5-20
Stabilization, antenna .....	6-17
STC .....	6-24
Steep gradient .....	5-33
Storm height, estimation .....	4-76

## T

TEST .....	4-52
Test display, Boeing .....	4-55
Test mode (TEST) .....	4-52
TEST, Airbus .....	4-52
TEST, Boeing .....	4-53
TFR .....	4-20
Thunderstorm, radar top .....	4-76
Thunderstorm, reflectivity .....	3-1, 5-5
Thunderstorms .....	5-8

Subject	Page
Thunderstorms, characteristics .....	5-14
Thunderstorms, dissipating stage .....	5-10
Thunderstorms, gust front .....	5-14
Thunderstorms, introduction .....	5-8
Thunderstorms, mature stage .....	5-9
Thunderstorms, multi-cell .....	5-11
Thunderstorms, single-cell development .....	5-8
Thunderstorms, squall lines .....	5-20
Thunderstorms, steady-state .....	5-13
Thunderstorms, towering cumulus stage .....	5-9
Thunderstorms, vaulting .....	5-15
Tilt, annunciation .....	4-11
Tilt, climb .....	4-64
Tilt, control .....	4-17, 4-61
Tilt, descent .....	4-66
Tilt, high altitude .....	4-70
Tilt, low altitude .....	4-63
Tilt, mid altitude .....	4-69
Tilt, over water .....	4-72
Towering cumulus .....	5-9
Transfer, Boeing .....	4-20
TURB .....	4-31
Turbulence mode (TURB), Airbus only .....	4-31
Turbulence, Doppler detection .....	6-32
 <b>U</b>	
Update rates .....	3-7
 <b>V</b>	
Vaulting, protection from .....	4-23
Vaulting, thunderstorms .....	5-15
 <b>W</b>	
Weather cells, oceanic .....	5-16
Weather mode (WX) .....	4-27
Weather plus turbulence mode (WX+T) .....	4-28
Weather, detection .....	4-22
Weather, long range detection .....	4-25, 4-79
Weather, non-reflective .....	5-37
Weather, total picture .....	4-82

---

Subject	Page
Windshear .....	5-26, 6-33
Windshear alert activation regions, Airbus .....	6-40
Windshear alert activation regions, Boeing .....	6-42
Windshear detection, automatic enable .....	6-35
Windshear event .....	6-33
Windshear philosophy .....	6-36
Windshear, ADVISORY .....	4-51
Windshear, alerts .....	4-50
Windshear, CAUTION .....	4-51
Windshear, coverage (Airbus/Retrofit aircraft) .....	4-46
Windshear, coverage (Boeing aircraft) .....	4-48
Windshear, detection .....	4-45
Windshear, MVD™ recording .....	6-43
Windshear, WARNING .....	4-50
WX .....	4-27
WX+T .....	4-28

This page intentionally left blank

This page intentionally left blank

Collins Aviation Services  
Rockwell Collins, Inc.  
Cedar Rapids, IA 52498

**Rockwell**  
**Collins**